













ordering online
(product categories)

-  cabinets
-  carcass
-  cabinets available to order
-  drawers
-  doors
-  glass
-  worktops
-  decorative infill panels
-  plinths
-  cornices and pelmets
-  accessories
-  Domestic appliances



compare the systems

cabinet type
D1ST/5-45/82-P/S

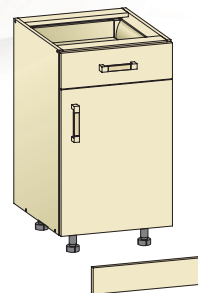

cabinet type
NKD1S-50/82-P/S

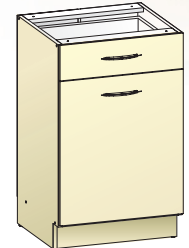

cabinets

- 1 single colour carcasses with melamine surface
- 2 carcasses are available in 11 colours
- 3 visible edges are covered with PVC edgings
- 4 all base units have adjustable legs
- 5 the height of the base unit could be increase by 50 mm
- 6 plinths are sold separately, the adjustable legs
- 7 Wall units are equipped with adjustable hangers
- 8 drawers type METABOX or TANDEMBOX produced by Blum
- 9 hinges by BLUM
- 10 The depth of base units 508 mm or 560 mm
- 11 the depth of wall units and worktop mounted cabinets 300 mm
- 12 possibility of extension of complete cabinet - from 70 to 150
- 13 on offer cabinets for housing domestic appliances
- 14 non-typical carcasses may be ordered

worktops

- 15 worktops # 38 available in 12 colours
- 16 + 2 colours in thickness of 28 or 38 mm
- 17 front edge with curved on both sides
- 18 worktops are made for customer requier

accessories

- 19 types of handles (102 models)
- 20 types of cornices and plinths 5 patterns in door and/or carcass colour
- 21 worktop accessories include: joining strips, front strips, thickening strips, bracket strips
- 22 apart from above accessories in SPK kitchen offer are: cabinet equipment, rail system, storage columns, glass shelves, hoods, tables and chairs

cabinets

- 1 carcasses with melamine surface in Dark Apple/White colours
- 2 visible edges are covered with melamine
- 3 all base units are fitted on the floor
- 4 base units available in standard height (820 mm)
- 5 the plinth is fixed the base unit
- 6 wall units are equipped with typical hangers
- 7 drawers made from panels on roller tracks
- 8 typical hinges
- 9 The depth of base units is 450 mm or 550 mm
- 10 The depth of wall units is 288 mm
- 11 possibility of extension - 1-2 sets + from 0 to 29 complete cabinets
- 12 possibility of housing oven in cabinet NKDP-60/82-K
- 13 only standard cabinets offered standard

worktops

- 1 worktop in Pietra Biezowa colour #28 mm
- 2 front edge with curved on 1 side
- 3 worktops available in standard lengths

accessories

- 1 handle specified for door
- 2 types of cornices
- 3 joining strip

SYSTEM IN A NUTSHELL SPK 2007

kitchens

R07021_12.06.BRW

CONTACTS

Marketing Department
 telephone + 48 (0) 84 68 50 202
 fax + 48 (0) 84 68 50 290
 e-mail marketing@brwsa.pl

BLACK RED WHITE
 www.brw.com.pl

SYSTEM IN A NUTSHELL

BLACK RED WHITE
 furniture for all generations

edition 2.0 06.2007

index

[3]P Trzy Zyczenia Patyna.....	p. 2,22,76,112
[4] Cztery Pory Roku.....	p. 2,23,112
[7] Siódme Niebo.....	p. 2,24,112
[9] Dziewiąta Symfonia.....	p. 2,22,112
[11] Strategio XI Mądry.....	p. 2,6,48,77,112,115-117,120,121
[12]P Tuzin Róż Patyna.....	p. 2,25,76,112
[14] Insygnata XIV Dumna.....	p. 2,9,48,77,
	112,114-117,120,121
[15] Artycja XV Dobra.....	p. 2,10,48,76,77,
	112,115-117,120,121
[16] Diadema XVI Piękna.....	p. 2,11,48,76,77,
	112,114-117,120,121
[22] Imperor XXII Łaskawy.....	p. 2,7,48,77,
	112,114-117,120,121
[25] Troniusz XXV Sprawiedliwy.....	p. 2,8,48,77,
	112,114-117,120,121
34 th Avenue.....	p. 3,16,48,112,120,121
35 th Avenue.....	p. 3,17,18,48,112,120,121
36 th Avenue.....	p. 3,18,48,112,120,121
41 st Milk Street.....	p. 3,28,112
46 th Sesame Street.....	p. 3,28,112
51 st Vanilla Street.....	p. 3,29,112
56 th Cherry Street.....	p. 3,29,112
61 st Pudding Street.....	p. 3,30,112
71 st Street.....	p. 3,31,112
72 nd Street.....	p. 3,31,112
74 th Street.....	p. 3,31,112
75 th Street.....	p. 3,31,112
76 th Street.....	p. 3,31,112
90 ^o / 135 ^o rail bend.....	p. 94
A	
A frame.....	p. 16-19,28,29,31,38-40,44,45,53
A3 frame.....	p. 16-19,28,29,31,38-40,44,45
hoods type Atridite	p. 118
Airone M mounting.....	p. 108
Airone M sets.....	p. 106,108,109
Alta Temperatura glazing.....	p. 8
aluminium angle joiner.....	p. 74
aluminium worktop thickening strip corners.....	p. 75
aluminium worktop thickening strip ends.....	p. 75
aluminium worktop thickening strip.....	p. 75
aluminium frames.....	-> A frame, A3 frame
aluminium gap joiner.....	p. 74
aluminium side end.....	p. 74
Amata hoods.....	p. 114-117
anti-slip mat for TANDEMBOX drawers.....	p. 90
ARKADA	p. 25,49
ARTYCJA chair.....	p. 121
Artycja XV Dobra [15].....	-> [15] Artycja XV Dobra
Artycja.....	-> ARTYCJA chairs
attachment ring.....	p. 98,100
B	
base strip A	p. 22-25,34,41-43,76-77
base strip D	p. 11,76,77
base strip P	p. 10,76,77
base strip W	p. 6,7,8,9,11,37,77
blender DBNW45-4/82	p. 62,69
blender DBNW60-5/82	p. 62,69
Blum.....	p. 52,53,85-91,110,111
BLUMOTION for doors.....	p. 110
bottle rack.....	p. 86,90,91
bottle tray.....	p. 86,90,91
BOXSIDE side.....	p. 86,90,91
BOXSIDE side.....	p. 85 or -> BOXSIDE side
BRW film design.....	p. 4
BRW Line.....	p. 4,5,19,23,24,29,41-47,51,52,56-58,76
cabinet construction.....	p. 52
cable connecting fluorescent mounting.....	p. 109
Candy	p. 56
CAPITAL	p. 3,16-21,48,51,52,56-58,76
carbon filter (anti smell).....	p. 115,117-119
cargo baskets.....	p. 82
cargo.....	-> cargo baskets
central shelf.....	p. 99,100
chairs in non-standard colouring.....	p. 122,123
chairs, 34 th Avenue.....	p. 121
chairs, 35 th Avenue.....	p. 121
chairs, 36 th Avenue.....	p. 121
chairs, ARTYCJA	p. 121
chairs, DIADEMA	p. 121
chairs, IMPEROR	p. 121
chairs, INSYGNATA	p. 121
chairs, STRATEGIO	p. 121
chairs, TRONIUS	p. 121
Classic Line.....	p. 2,34-37,41-43,46,51,52,56-58,76
Clear with Strip glazing.....	p. 22,36
Clear glazing.....	p. 23-25,34,35,41-43,49
Clip	-> hinges
column crown.....	p. 100
column sleeves.....	p. 98
COMBI type drawer.....	p. 86,90,91
connector wiring.....	p. 109
containers for spices.....	-> set of containers for spices
Cristal glazing.....	p. 37
crown strip / base strip N	p. 16-18,28-31,
	38-40,44,45,76
crown strip A	p. 22-25,34-36,41-43,76-77
crown strip D	p. 11,76,77
crown strip P	p. 10,76,77
crown strip W	p. 6,7,8,9,37,77
Cztery Pory Roku [4].....	-> [4] Cztery Pory Roku

index

D
 DBZ blenders p. 63
Decor Neutro glazing..... p. 9
 decorative infill panel..... p. 6-11,16-18,48
Dekorado p. 2,36,76,112
Demeter hoods p. 114-117
DIADEMA chair p. 121
DIADEMA tables..... p. 120
 Diadema XVI Piękną [16]-> [16] Diadema XVI Piękną
 dielectric off-switch p. 108,109
Diona p. 3,38,112
 dish and cutlery drainer units p. 82,95
Diverso glazing p. 7
 DNWU worktops p. 69
 domestic equipment housing..... p. 56-58
 double sided laminated worktop filler panels... p. 68
 double wire storage basket..... p. 95
 4-drawer layout p. 54,55
 5-drawer layout p. 54,55
 drilling pattern p. 110,111
Duet extra sets p. 106,109
 Dźwięki Symfonia [9] [9] Dźwięki Symfonia

E
 EKKO-SYSTEM mat..... p. 84
 EKKO-SYSTEM p. 84
 EKFRAN p. 4,16,17,29,44,80
Elianto glazing..... p. 7
 EXPANDO cross mounting plate..... p. 110
 extension connector p. 108
 fabrics..... p. 121,123

F
 FALA p. 4,24,42,49,78
 Faimec p. 114-119
 Festool p. 110,112
 filler panels in carcass colours p. 63-65
Fiore Opaco glazing p. 6
 crosswise divider for TANDEMBOX drawers
 p. 84,86,90,91
 FORMA p. 31,49,80
 front strips p. 72-73
Frosted glazing p. 16-19,28,29,31,38-40,44,45,49
Frosted with an Ellipse glazing... p. 23-25,34,35,41-43,49
Frosted with a Rectangle Pattern glazing p. 30,31,49

G
Gemma glazing p. 10
Ghibli M1 sets p. 106,109
 glass lamp shades..... p. 108
 glass shelf for glasses p. 99
 glass shelf with rail p. 99
 glass shelf bracket # 8-50 mm p. 103
 glass shelf bracket Orient..... p. 103
 glass shelf bracket p. 103,104
 glass shelves mounted p. 104
 glazing, **Alfa Temperatura** p. 8
 glazing, **Cristal** p. 37
 glazing, **Decor Neutro** p. 9
 glazing, **Diverso** p. 7
 glazing, **Elianto** p. 7
 glazing, **Fiore Opaco** p. 6
 glazing, **Gemma** p. 10
 glazing, **Clear with Strip** p. 22,36
 glazing, **Clear** p. 23-25,34,35,41-43,49
 glazing, **Frosted** p. 16-19,28,29,31,38-40,44,45,49
 glazing, **Master** p. 16-19,28,29,31,38-40,44,45,49
 glazing, **Rosa** p. 11
 glazing, **Rough** p. 22-25,34,35-37,41-43,49

H
 hanging strip p. 75,110
 handles group **D** p. 79
 handles group **G** p. 19,78,79,81
 handles group **M** p. 78
 handles group **N** p. 19,79-81
 handles group **P** p. 79
 Hedar..... p. 3,39,112
 hinge hole cover p. 111
 hinges..... p. 52,53
 HLT (Halogen Light Tech) p. 106-109
 holder for chopping board p. 97
 holder for dishes p. 96
 holder for mugs p. 96
 hoods, **Afrodite** p. 118
 hoods, **Amata** p. 114-117
 hoods, **Demeter** p. 114-117
 hoods, **Ismena** p. 114-115
 hoods, **Latona** p. 114-117
 hoods, **Marte** p. 118
 hoods, **Mercurio** p. 119
 hoods, **Nemezis** p. 115
 hoods, **Saturno Vetro** p. 119
 hoods, **Venus** p. 115-117

I
 IMPEROR chair p. 121
 IMPEROR tables p. 120
Imperator> IMPEROR chair, IMPEROR tables
 insert for knives p. 86-88
 inserts for METABOX drawers p. 85
 inserts to TANDEM BOX drawers..... p. 85
 INSYGNATA tables p. 120
 INSYGNATA chair p. 121
 Imperor XXII Łaskawy [22] [22] Imperor XXII Łaskawy

I (continued)
 Insygnata XIV Dumna [14].....> [14] Insygnata XIV Dumna
Insygnata-> INSYGNATA chair, INSYGNATA tables
Ismena hood p. 114-115

K
 KARTA p. 4,23,41,49
Komo 1 sets p. 106,109
KU003> storage columns in sets
KU004> storage columns in sets

L
Latona hoods p. 114-117
 lead strip p. 75
Ledo p. 2,35,49,76,112
 lengthways division for TANDEMBOX drawers..... p. 84,86,90,91
 lid handle..... p. 97
 lighting points p. 109
 lighting sets p. 106-109
 lower cabinet legs..... p. 102
 lower storage column attachment p. 98,100

M
 Magic CORNER baskets..... p. 82
Marte hoods p. 118
Master glazing..... p. 16-19,28,29,31,38-40,44,45,49
 MAXI bin p. 84
 measuring formats..... p. 64-65
 Melos..... p. 2,37,77,112,114-117
Mercurio hoods p. 119
 METABOX drawer p. 52,53,85
 METABOX> drawer METABOX
 metal filter (anti fat) p. 115,117-119
 MIDI bin p. 84,91
 MINI bin p. 84,91
 MINI double wire storage basket p. 95
 MINI single wire storage basket..... p. 95
 Modern Line..... p. 3,19,38-40,47,51,52,56-58,76

Modul> hinges
 mounting worktop rail p. 94
 mounting splash-back battens p. 73
 mounting crown and cabinet base strips..... p. 77
 mounting ordinary leg extension..... p. 102
 mounting wall rail..... p. 94

N
Nemezis hood p. 115
Neo sets p. 107,109
 non-standard cabinets..... p. 4,45
 non-typical cabinets p. 58,59
 non-typical orders p. 58,59
 ordering worktops finished with thickening
 strip p. 75
 ordering worktops p. 70,71
 ordering filler panels p. 64,65
 ordering non-typical cabinets ...> non-typical orders
 ordering plinths with filler panels
 in carcass colours p. 62

O
 ordinary leg extension p. 102
 ORGA-LINE drawer organisation system..... p. 86-91
 ORGA-LINE...> ORGA-LINE drawer organisation system
Orient sets p. 106,108,109
Orient> bracket for **Orient** shelf,
Orient plus sets p. 106,108,109
 ornamental rod p. 100
 Ottimo..... p. 111,112

P
 plastic plinth corners p. 61
 plate rack p. 86,87
 plinth end from plastic p. 61
 plinth joiner from plastic>
 plinth seal> sealing profile
 plinths..... p. 52,60-62
 PORTAL..... p. 4,43,49

R
 rail components p. 94
 rail connector p. 94
 rail drainer p. 95
 rail holder seat washer p. 94
 rail hook p. 97
 rail stopper p. 94
 rail tube p. 94
 rails for crosswise division p. 85
 RAMA p. 22
 Rejs p. 82,83,92-99,102,103
 repair kit p. 111
Rosa glazing p. 11
Rosa p. 2, 34, 49, 112
Rough glazing p. 22-25,34,35-37,41-43,49
 rotating shelves/carousels p. 83
 round ornamental leg "150" p. 102
 Royal p. 2,6-15,48,51,52,56-58

S
S-2000 H sets p. 107,109
S-2000 H with spacer sets p. 107,109
Saturno Vetro hoods p. 119
SAVOY Small tables..... p. 120
 screw joins> worktop connecting screws
 sealing profile..... p. 60
Selene 1 fluorescent mounting..... p. 109
 Sentima..... p. 2,22-27,51,52,56-58,76
 set of containers for spices p. 97

S (continued)
 sets, **Airone M** p. 106,108,109
 sets, **Duet extra** p. 106,109
 sets, **Ghibli M1** p. 106,109
 sets, **Komo 1** p. 106,109
 sets, **Neo** p. 107,109
 sets, **Orient** p. 106,108,109
 sets, **Orient plus** p. 106,108,109
 sets, **S-2000 H** p. 107,109
 shelf brackets p. 103,104
 shelf for glasses p. 99
 side shelf p. 99,100
 single arm hanger p. 99
 single wire storage basket..... p. 95
 Siódme Niebo [7]> [7] Siódme Niebo
 Siro p. 100,101

SLIM hoods p. 56
 SOFT p. 30
 SPAX double mounting plate
 square ornamental leg "150" p. 102
 storage column connector p. 98
 storage column elements p. 98,100
 storage column rod p. 98
 storage column side attachment..... p. 98,100
 storage column systems p. 98,99
 storage columns in sets p. 100
 straight/retro rail holder p. 94
 STRATEGIO chair p. 121
 STRATEGIO tables p. 120
 Stratego XI Madry [11].....> [11] Stratego XI Madry
 Stratego> STRATEGIO chair, STRATEGIO tables
 support legs p. 102
 supporting rod p. 100
 suspended containers p. 111

T
 tables in non-standard colours..... p. 122,123
 tables, 34" Avenue p. 120
 tables, 35" Avenue p. 120
 tables, DIADEMA p. 120
 tables, IMPEROR p. 120
 tables, INSYGNATA p. 120
 tables, SAVOY Small p. 120
 tables, STRATEGIO p. 120
 tables, TRONIUS p. 120
 TAFLA p. 18,28,80
 TAFLA MDF p. 4,45
 TANDEMBOX drawer organisers p. 86-89
 TANDEMBOX drawer p. 52,53,84-91
 telescopic bracket..... p. 102,103
Telesto p. 3,40,112
 TRAFFIC p. 3,19,28-33,51,52,56-58,76
 transformer p. 109
 triple arm hanger p. 99,100
 TRONIUSZ chair p. 121
 TRONIUSZ tables..... p. 120
 Troniusz XXV Sprawiedliwy
 [25] Troniusz XXV Sprawiedliwy
 Troniusz.....> TRONIUSZ chair, TRONIUSZ tables
 Trzy Zyczenia Patyna [3]P.....> [3]P Trzy Zyczenia Patyna
 Tuzin Róż [12]> [12] Tuzin Róż
 types of worktop finishes p. 70
 types of finish of lighting panel p. 64

U
 upper cap of storage column p. 98
 upper storage column attachment..... p. 98,100



V
 ventilation grill p. 61
 Venus hoods p. 115-117

W
 waste bin p. 83,84,91
 wicker basket p. 83
 wire storage basket - mugs p. 96
 wire storage basket for books p. 97
 wire storage basket for bottles p. 96
 wire storage basket for glasses MINI p. 96
 wire storage basket for glasses..... p. 96
 wire storage basket for paper and film p. 97
 wire storage basket for paper p. 97
 wire storage basket for spices p. 97
 wire storage baskets..... p. 95-97
 wire storage corner p. 95
 worktops with curvature.....> worktop filler panels
 with curvature p. 111
 worktops with PVC rim.....> worktop filler
 panels with PVC rim
 worktops with SSV rim.....> worktop filler panels
 with SSV rim

worktops p. 66-71
 worktop bracket..... p. 74,102,103
 worktop connecting screws p. 75
 worktop filler panels with curvature p. 67
 worktop filler panels with PVC rim p. 68
 worktop filler panels with SSV rim p. 68
 worktop front corner strips p. 72,73
 worktop panels with curvature.....> worktops
 with curvature

worktop rings> sealing profile p. 100
 worktop strip ends p. 72,73

BLACK RED WHITE cabinets standing on worktops

TI-5/121-B	packages	carcass dimensions	carcass colours	appear in	comments
	carcass	TI-5/121	width 50 mm	BU	<i>Royal</i> [14] [15]
	door	1198/50-I	depth 300 mm	DW	<i>Sentima</i> [3]P [4] [7] [9] [12]P
			height 1208 mm	OLS WIEL WISE WISP	
					plaster may be applied between cabinets or at end assembly from left or right side
TROL-60/121	packages	carcass dimensions	carcass colours	appear in	comments
	carcass	TROL-60/121	width 600 mm	BI WE	CAPITAL [34] [35] [36]
			depth 300 mm	BE WIEL	TRAFFIC [4-] [5-] [6-] [7-]
			height 1208 mm	BU WISE DMI WISP DW SZ KLN OLS	Modern , Brown EKR TAF_MDF
					cabinet is available with roller screen in colour aluminium (standard) or steel (option)



classic kitchen door types2
 modern kitchen door types3
 BRW Line - cabinet doors available to order only4

<i>Royal</i>	Royal group cabinet doors6 complete Royal 4 cabinets12 complete Royal 5 cabinets14
CAPITAL	CAPITAL group cabinet doors16 aluminium frames19 complete CAPITAL cabinets20
<i>Sentima</i>	SENTIMA group cabinet doors22 complete Sentima cabinets26
TRAFFIC	TRAFFIC group cabinet doors28 complete TRAFFIC cabinets32
<i>Classic</i> <small>LINE</small>	CLASSIC LINE group cabinet doors34
<i>Modern</i> <small>LINE</small>	MODERN LINE group cabinet doors38
BRW <small>LINE</small>	BRW LINE group cabinet doors41 complete Classic Line cabinets46 complete Modern Line cabinets47

Decorative infill panels48
 glazing installed on site49
 carcass - colour and appearance50
 carcass - cabinets construction, index, structure52
 carcass - drawers, hinges53
 layouts for 4- and 5-drawer arrangements54
 cabinets heights55
 larder units56
 cabinets available to order58
 plinths60
 infill panels62
 plinths in carcass colour63
 plinths in carcass colour – ordering guide64
 workops - colours and sizes66
 workops – ordering guide70
 workops accessories72
 cornices and pelmet76
 handles78
 cabinet equipment82
 drawers equipment84
 rail system94
 storage columns98
 adjustable legs102
 brackets103
 glazing shelves104
 lighting106
 other accessories110
 installers accessories111
 hoods114
 tables and chairs120
 colour codes124

doors
glazing

carcasses
cabinets

plinths

worktops
worktops accessories

cornices
and pelmet

accessories

hoods
tables and chairs

classic kitchens

Royal
p. 6-15



4

[11]
STRATEGIO XI
MĄDRY



4

[22]
IMPEROR XXII
ŁASKAWY



4

[25]
TRONIUSZ XXV
SPRAWIEDLIWY



5

[14]
INSYGNATA XIV
DUMNA



5

[15]
ARTYCJA XV
DOBRA



5

[16]
DIADEMA XVI
PIĘKNA



5

Rosa
Antique Cherry Patina



5

Ledo
Italian Cherry Patina



5

Melos
Orange Birch

Classic
LINE
p. 34-37, 46



5

Dekorado
Calvados Patina



5

[3P]
Trzy Łyczenia Patyna

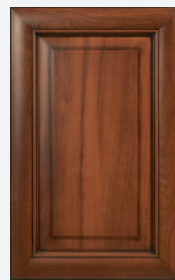

5

[9]
Dziękuję Symfonia

classic kitchens
Sentima
p. 22-27



5

[4]
Cztery Pory Roku



5

[7]
Siedme Niebo



5

[12P]
Tuzin Róż Patyna



5

36th Avenue



5

34th Avenue



5

35th Avenue

modern kitchens
CAPITAL
p. 16-21

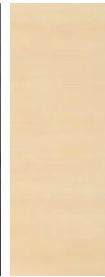

5

Diona



Wenge



Golden Cherry



Milan Oak



Nida Maple

Modern
LINE
p. 38-40, 47



5

Hedar



5

Telesto

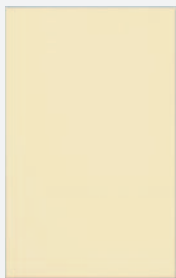

5

41st Milk Street



5

46th Sesame Street

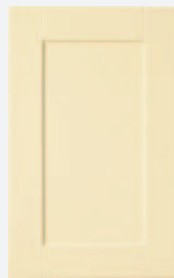

5

51st Vanilla Street

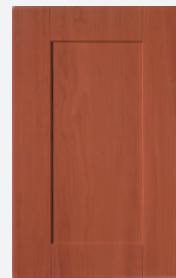

5

56th Cherry Street

modern kitchens
TRAFFIC
p. 28-33



5

61st Pudding Street

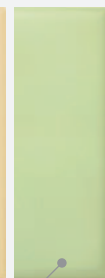

5

71st Street

72nd Street

74th Street

75th Street

76th Street



5

BRW LINE
classic doors
p. 41-43, 46

available colours 

type **KARTA** (KAR)



5

available colours 

type **FALA** (FAL)



5

available colours 

type **PORTAL** (POR)



5

BRW LINE
modern doors
p. 44-45, 47

available colours 

type **EKLAN** (EKR)



5

available colours 

type **TAFLA MDF** (TAF_MDF)



WHITE

101

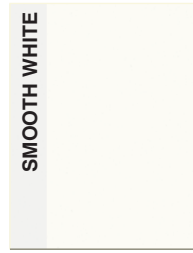

SMOOTH WHITE

102



colour withdrawn

103



SIBERIAN BIRCH

104



CINAMON OAK

111

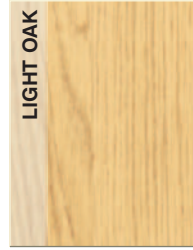

LIGHT OAK

112



RUSTIC OAK

113



ALDER

114



GOLDEN OAK

121



colour withdrawn

122



colour withdrawn

123



CALVADOS

124



DARK CELADON

131

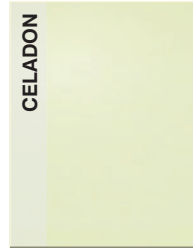

CELADON

132

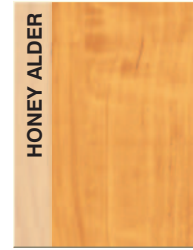

HONEY ALDER

133



colour withdrawn

134



COMBED OAK

141



ITALIAN ASH

142



ANTIQU OAK

143



VERTICAL OAK

144



ANTIQU CHERRY

151



WHITE GLOSS

152*



BORDEAUX GLOSS

153*



VANILLA GLOSS

154*



105



106



107



108



109



110

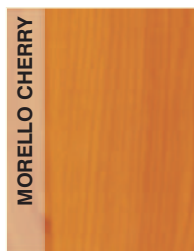

115



116

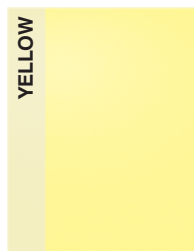

117



118



119



120



125



126



127



128



129



130

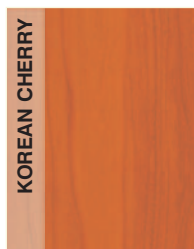

135



136



137

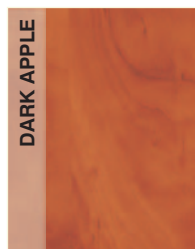

138



139

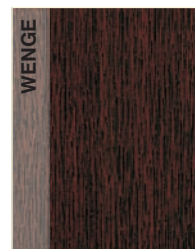

140



145



146

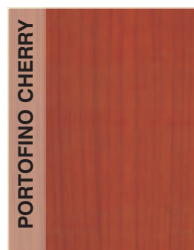

147

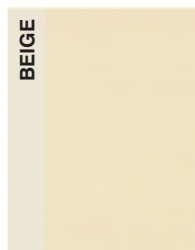

148

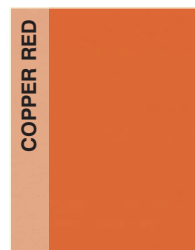

149

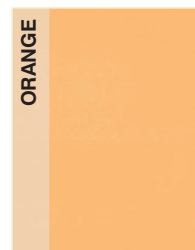

150

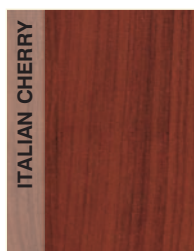

155



156



The door finishes
colour samples (in A4
 or A5 format) are
 available from
 BRW Sp.z.o.o
 Marketing
 Department





[11] STRATEGIO XI MĄDRY

door colour Light Chestnut
 material solid wood (chestnut)
 thickness 20 mm
 glazing Fiore Opaco factory fitted
 lattice Light Chestnut factory fitted
 carcass Medium Chestnut
 cornice and pelmet **W**

Royal 4

are available in matching door colours



hoods p. 114-117

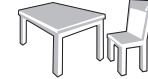

tables and chairs p. 120-121

available door types

- 110/596-K (-S).pattern u1
- 146/146-Spattern u1
- 176/296-ST.....pattern u2
- 176/446-Bpattern u2
- 176/446-ST.....pattern u2
- 176/596-Bpattern u2
- 176/596-ST.....pattern u2
- 176/896-E
- 176/896-STpattern u2
- 304/446-STH
- 304/446-STV
- 355/296-ST
- 355/446-O
- 355/446-OH
- 355/446-ST
- 355/446-STH
- 355/446-STV
- 355/446-VO
- 355/596-O
- 355/596-OH
- 355/596-ST
- 355/596-STH
- 355/596-STV
- 355/596-VO
- 355/896-OH
- 355/896-ST
- 355/896-STH
- 355/896-STV
- 355/896-VO
- 393/446-O
- 393/596-O
- 534/296
- 534/296-ST
- 534/446
- 534/446-ST
- 534/596
- 534/596-ST
- 566/596-B
- 570/446-M
- 570/596-M
- 643/596
- 713/146-CX.....pattern u1
- 713/150-B³⁾
- 713/276-N¹⁾
- 713/296
- 713/296-C
- 713/296-CC
- 713/296 446-U²⁾
- 713/317-N¹⁾
- 713/396
- 713/396-H
- 713/396-V
- 713/446
- 713/446-H
- 713/446-LSW (-PSW)
- 713/446-M
- 713/446-LV (-PV)
- 713/456
- 713/466-UH
- 713/466-LUV (-PUV)
- 713/596
- 713/596-H
- 713/596-M
- 713/596-LV (-PV)
- 943/150-B³⁾
- 943/276-N¹⁾
- 943/296
- 943/396
- 943/396-H
- 943/396-V
- 943/446
- 943/446-H
- 943/446-LV (-PV)
- 943/466-UH
- 943/466-LUV (-PUV)
- 943/596
- 943/596-H
- 943/596-LV (-PV)
- 1019/446-H
- 1019/446-LV (-PV)
- 1019/596-LV (-PV)
- 1081/446
- 1081/596
- 1198/466-UH
- 1198/466-LUV (-PUV)
- 1247/296-CC
- 1247/446
- 1247/446-LSW (-PSW)
- 1247/596
- 1327/446
- 1327/446-H
- 1327/446-LV (-PV)
- 1327/596
- 1500/140-K

simplified door types



selection of characteristic door types

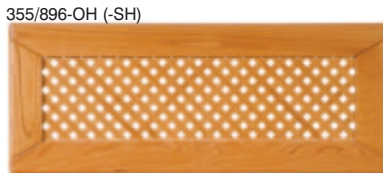

folding doors for the 713/296 446-U corner unit (internal)

713/466-UH

713/466-LV



713/276-N¹⁾ for cabinet GNW-60/72
 713/317-N¹⁾ for cabinet DNW-90/82
 943/276-N¹⁾ for cabinet GNW-60/95

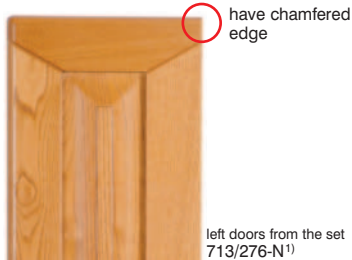

glazing



Fiore Opaco



plain design is available in the following door types:

- 304/446-SV
- 355/446-V
- 355/446-SV
- 355/596-V
- 355/596-SV
- 355/896-SV
- 355/896-VO
- 713/396-V
- 943/396-V

cornice and pelmet

for available cornices and pelmets, see page 77 for details >>>

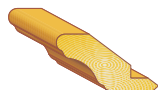

cornice **W**
 colour Light Chestnut
 material MDF, veneer
 available length 2700 mm



pelmet **W**
 colour Light Chestnut
 material MDF, veneer
 available length 2700 mm

1) set of doors for corner units (internal)
 2) set of doors for corner units (external)
 3) decorative infill panel, p. 48



[22] IMPEROR XXII ŁASKAWY

door colour **Walnut**
 material **solid wood (acacia)**
 thickness **25 mm**
 glazing **Elianto, Diverso factory fitted**
 lattice **Walnut factory fitted**
 carcass **Chestnut**
 cornice and pelmet **W**

Royal 4

also available in colours of the door



hoods p. 114-117



tables and chairs p. 120-121

available door types

- 110/596-K (-S) .pattern u1
- 146/146-Spattern u1
- 176/296-ST.....pattern u1
- 176/446-B.....pattern u2
- 176/446-ST.....pattern u2
- 176/596-B.....pattern u2
- 176/596-ST.....pattern u2
- 176/896-E
- 176/896-ST.....pattern u2
- 304/446-STH
- 304/446-STV
- 355/296-ST
- 355/446-O
- 355/446-OH
- 355/446-ST
- 355/446-STH
- 355/446-STV
- 355/446-VO
- 355/596-O
- 355/596-OH
- 355/596-ST
- 355/596-STH
- 355/596-STV
- 355/596-VO
- 355/896-OH
- 355/896-ST
- 355/896-STH
- 355/896-STV
- 355/896-VO
- 393/446-O
- 393/596-O
- 534/296-L (-P)
- 534/296-ST
- 534/446-L (-P)
- 534/446-ST
- 534/596-L (-P)
- 534/596-ST
- 566/596-B
- 570/446-M
- 570/596-M
- 633/446-LE
- 633/446-LHE
- 633/446-LVE
- 633/446-PE
- 633/446-PHE
- 633/446-PVE
- 643/596-L (-P)
- 713/146-CXpattern u2
- 713/150-B³⁾
- 713/260-L (-P)
- 713/271-LN¹⁾ (-PN¹⁾)
- 713/296-C
- 713/296-CC
- 713/296-L (-P)
- 713/300-LR (-PR)
- 713/300-LRV (-PRV)
- 713/312-LN¹⁾ (-PN¹⁾)
- 713/396-L (-P)
- 713/396-LH (-PH)
- 713/396-LV (-PV)
- 713/446-L (-P)
- 713/446-LH (-PH)
- 713/446-LV (-PV)
- 713/446-LSW (-PSW)
- 713/446-M
- 713/456-L (-P)
- 713/596-L (-P)
- 713/596-LH (-PH)
- 713/596-LV (-PV)
- 713/596-M
- 943/150-B³⁾
- 943/271-LN¹⁾ (-PN¹⁾)
- 943/296-L (-P)
- 943/296-LE
- 943/296-PE
- 943/300-LRV (-PRV)
- 943/396-L (-P)
- 943/396-LH (-PH)
- 943/396-LV (-PV)
- 943/446-L (-P)
- 943/446-LH (-PH)
- 943/446-LV (-PV)
- 943/596-L (-P)
- 943/596-LH (-PH)
- 943/596-LV (-PV)
- 1019/446-LH (-PH)
- 1019/446-LV (-PV)
- 1019/596-LV (-PV)
- 1081/446-L (-P)
- 1081/596-L (-P)
- 1198/300-LRV (-PRV)
- 1247/296-CC
- 1247/446-L (-P)
- 1247/446-LSW (-PSW)
- 1247/596-L (-P)
- 1327/446-L (-P)
- 1327/446-LH (-PH)
- 1327/446-LV (-PV)
- 1327/596-L (-P)
- 1500/140-K

simplified door types



pattern u1
solid door
straight

pattern u2
routed solid door



doors: 713/271-LN¹⁾ (-PN¹⁾) for cabinet GNW-60/72
 713/312-LN¹⁾ (-PN¹⁾) for cabinet DNW-90/82
 943/271-LN¹⁾ (-PN¹⁾) for cabinet GNW-60/95



have chamfered edge

left doors from the set 713/271-LN¹⁾

selection of characteristic door types



glazing

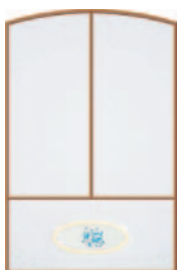

Elianto

basic design



plain design

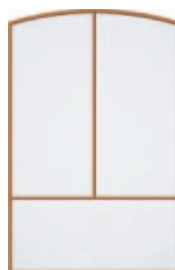

Diverso

basic design



plain design

plain design
available doors:

- 304/446-SV
- 355/446-LV (-PV)
- 355/446-SV
- 355/596-LV (-PV)
- 355/596-SV
- 355/896-SV
- 355/896-VO

cornice and pelmet

for available cornices and pelmets, see page 77 for details >>>



cornice **W**
 colour **Walnut**
 material **MDF, veneer**
 available length **2700 mm**



curved cornice **W**
 material **wood, veneer**



pelmet **W**
 colour **Walnut**
 material **MDF, veneer**
 available length **2700 mm**



curved pelmet **W**
 material **wood, veneer**

1) set of doors for corner units (internal)
 3) decorative infill panel, p. 48



[25] TRONIUSZ XXV SPRAWIEDLIWY

Royal 4

door colour **Chestnut**
 material **solid wood (chestnut)**
 thickness **24 mm**
 glazing **Alta Temperatura factory fitted**
 lattice **Chestnut factory fitted**
 carcass **Medium Chestnut**
 cornice and pelmet **W**

also available in colours of the door



hoods p. 114-117



tables and chairs p. 120-121

available door types

- 110/596-K (-S) .pattern u1
- 146/146-Spattern u1
- 176/296-ST.....pattern u1
- 176/446-B.....pattern u1
- 176/446-ST.....pattern u1
- 176/596-B.....pattern u1
- 176/596-ST.....pattern u1
- 176/896-E
- 176/896-ST.....pattern u1
- 304/446-STH
- 304/446-STV
- 355/296-ST
- 355/446-O
- 355/446-OH
- 355/446-ST
- 355/446-STH
- 355/446-STV
- 355/446-VO
- 355/596-O
- 355/596-OH
- 355/596-ST
- 355/596-STH
- 355/596-STV
- 355/596-VO
- 355/896-OH
- 355/896-ST
- 355/896-STH
- 355/896-STV
- 355/896-VO
- 393/446-O
- 393/596-O
- 534/296
- 534/296-ST
- 534/446
- 534/446-ST
- 534/596
- 534/596-ST
- 566/596-B
- 570/446-M
- 570/596-M
- 643/596
- 713/146-CX.....pattern u2
- 713/150-B³⁾
- 713/260
- 713/272-N¹⁾
- 713/296
- 713/296-C
- 713/296-CC
- 713/300-LR (-PR)
- 713/300-LRV (-PRV)
- 713/313-N¹⁾
- 713/396
- 713/396-H
- 713/396-LV (-PV)
- 713/446
- 713/446-H
- 713/446-M
- 713/446-LSW (-PSW)
- 713/446-LV (-PV)
- 713/456
- 713/596
- 713/596-H
- 713/596-M
- 713/596-LV (-PV)
- 943/150-B³⁾
- 943/272-N¹⁾
- 943/296
- 943/300-LRV (-PRV)
- 943/396
- 943/396-H
- 943/396-LV (-PV)
- 943/446
- 943/446-H
- 943/446-LV (-PV)
- 943/596
- 943/596-H
- 943/596-LV (-PV)
- 1019/446-H
- 1019/446-LV (-PV)
- 1019/596-LV (-PV)
- 1081/446
- 1081/596
- 1198/300-LRV (-PRV)
- 1247/296-CC
- 1247/446
- 1247/446-LSW (-PSW)
- 1247/596
- 1327/446
- 1327/446-LH (-PH)
- 1327/446-LV (-PV)
- 1327/596
- 1500/140-K

simplified door types



pattern u1
solid door
straight



pattern u2
routed solid
door

Please note: in some doors with lattice or glazing a routed decorative motif is applied (sketch 1 and 2)
 Doors with routed decoration
 304/446-SV, 355/446-SV (-LV; -PV), 355/596-LV (-PV), 355/596-SV, 355/896-SV (-VO), 1327/446-LV (-PV),
 304/446-SH, 355/446-SH (-LH; -PH), 355/596-LH (-PH), 355/596-SH, 355/896-SH (-OH), 1327/446-LH (-PH).

Simple routed motifs (basic) supplied in remaining doors with glazing or lattice (sketch 4 and 5) and also in all full doors (sketch 3 and 6).

doors:
 713/272-N¹⁾ for cabinet GNW-60/72
 713/313-N¹⁾ for cabinet DNW-90/82
 943/272-N¹⁾ for cabinet GNW-60/95



have chamfered edge
 left doors from the set 713/272-N¹⁾

selection of characteristic door types

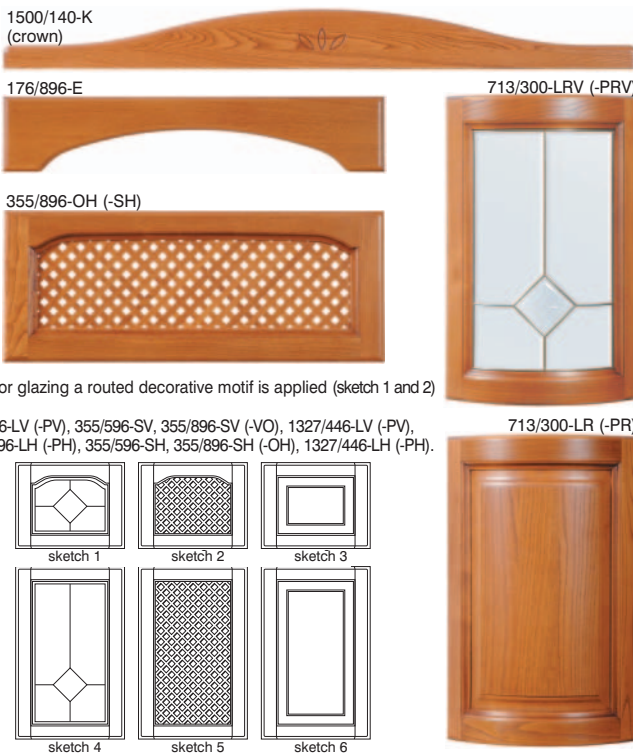

glazing



basic design

Alta Temperatura



decorative design

decorative design
 available doors:

- 304/446-SV
- 355/446-V
- 355/446-SV
- 355/596-V
- 355/596-SV
- 355/896-SV
- 355/896-VO
- 1327/446-V

cornice and pelmet

for available cornices and pelmets, see page 77 for details >>>

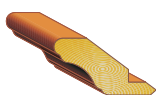

cornice **W**
 colour **Chestnut**
 material **MDF, veneer**
 available length **2700 mm**
 curved cornice **W**
 material **wood, veneer**



pelmet **W**
 colour **Chestnut**
 material **MDF, veneer**
 available length **2700 mm**
 curved pelmet **W**
 material **wood, veneer**

1) set of doors for corner units (internal)
 3) decorative infill panel, p. 48



[14] INSYGNATA XIV DUMNA

Royal 5

door colour **Morello Cherry**
 material **wood (lime), MDF, veneer (morello cherry)**
 thickness **20 mm**
 glazing **Decor Neutro factory fitted**
 carcass **Portofino Cherry**
 cornice and pelmet **W**

also available in colours of the door



hoods p. 114-117

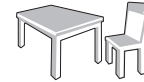

tables and chairs p. 120-121

available door types

- 75/596-Bpattern u1
- 87/596-Bpattern u1
- 110/596-K (-S)pattern u1
- 140/146-Spattern u1
- 140/296-STpattern u1
- 140/446-Bpattern u1
- 140/446-STpattern u1
- 140/596-Bpattern u1
- 140/596-STpattern u1
- 140/896-E
- 140/896-STpattern u1
- 250/446-ST
- 250/446-STV
- 284/296-ST
- 284/446-ST
- 284/446-STV
- 284/596-ST
- 284/596-STV
- 284/896-ST
- 284/896-STV
- 284/896-VO
- 316/596-O
- 355/446-O
- 355/446-VO
- 355/596-O
- 355/596-VO
- 393/446-O
- 393/596-O
- 500/596-B
- 500/596-O
- 570/296-L (-P)
- 570/296-ST
- 570/446-L (-P)
- 570/446-M
- 570/446-ST
- 570/596-L (-P)
- 570/596-M
- 570/596-ST
- 621/446-LDE (-LGE)
- 621/446-LVE
- 621/446-PDE (-PGE)
- 621/446-PVE
- 643/596-L (-P)
- 713/50-I
- 713/146-CXpattern u1
- 713/150-B³⁾
- 713/260-L (-P)
- 713/276-LN¹⁾ (-PN¹⁾)
- 713/296-C
- 713/296-CC
- 713/296-L (-P)
- 713/300-LR (-PR)
- 713/300-LRV (-PRV)
- 713/317-LN¹⁾ (-PN¹⁾)
- 713/396-L (-P)
- 713/396-LV (-PV)
- 713/446-L (-P)
- 713/446-LSW (-PSW)
- 713/446-LV (-PV)
- 713/446-M
- 713/456-L (-P)
- 713/596-L (-P)
- 713/596-LV (-PV)
- 713/596-M

simplified door types

selection of characteristic door types



pattern u1
 solid door
 straight

doors: 713/276-LN¹⁾ (-PN¹⁾) for cabinet GNW-60/72
 713/317-LN¹⁾ (-PN¹⁾) for cabinet DNW-90/82
 943/276-LN¹⁾ (-PN¹⁾) for cabinet GNW-60/95



have chamfered edge

left doors from the set 713/276-LN¹⁾



1500/140-K (crown)

140/896-E

621/446-LE
 713/300-LR (-PR)

621/446-PVE
 713/300-LRV (-PRV)

713/50-I (pilaster)

glazing



basic design

Decor Neutro

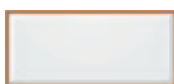

plain design

plain design
 available doors:
 250/446-SV
 284/446-SV
 284/596-SV
 284/896-SV
 284/896-VO
 355/446-LV (-PV)
 355/596-LV (-PV)

cornice and pelmet

available cornices and pelmets, see page 77 for details >>>

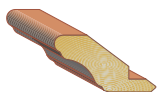

cornice **W**
 colour **Morello Cherry**
 material **MDF, veneer**
 available length **2700 mm**
 curved cornice **W**
 material **wood, veneer**



pelmet **W**
 colour **Morello Cherry**
 material **MDF, veneer**
 available length **2700 mm**
 curved pelmet **W**
 material **wood, veneer**

1) set of doors for corner units (internal)
 3) decorative infill panel, p. 48

available door types



[15] ARTYCJA XV DOBRA

door colour **Honey Alder**
 material **solid wood (alder)**
 thickness **20 mm**
 glazing **Gemma factory fitted**
 lattice **Honey Alder factory fitted**
 carcass **San Alder**
 cornice and pelmet **P**

Royal

also available in colours of the door



hoods p. 114-117



tables and chairs p. 120-121

- 75/596-B.....pattern u1
- 87/596-B.....pattern u1
- 110/596-K (-S).....pattern u2
- 140/146-S.....pattern u1
- 140/296-ST.....pattern u2
- 140/446-ST (-B).....pattern u2
- 140/596-ST (-B).....pattern u2
- 140/896-E
- 140/896-ST.....pattern u2
- 250/446-ST.....pattern u3
- 250/446-STH.....pattern u3
- 250/446-STV.....pattern u3
- 284/296-ST.....pattern u3
- 284/446-ST.....pattern u3
- 284/446-STH.....pattern u3
- 284/446-STV.....pattern u3
- 284/596-ST.....pattern u3
- 284/596-STH.....pattern u3
- 284/596-STV.....pattern u3
- 284/896-OH.....pattern u3
- 284/896-ST.....pattern u3
- 284/896-STH.....pattern u3
- 284/896-STV.....pattern u3
- 284/896-VO.....pattern u3
- 316/596-O
- 355/446-O
- 355/446-OH
- 355/446-VO
- 355/596-O
- 355/596-OH
- 355/596-VO
- 393/446-O
- 393/596-O
- 500/596-B
- 500/596-O
- 570/296-L (-P)
- 570/296-ST
- 570/446-L (-P)
- 570/446-M
- 570/446-ST
- 570/596-L (-P)
- 570/596-M
- 570/596-ST
- 645/446-LDE (-LGE)
- 645/446-LHE
- 645/446-LVE
- 645/446-PDE (-PGE)
- 645/446-PHE
- 645/446-PVE
- 643/596-L (-P)
- 713/50-I
- 713/146-CX.....pattern u1
- 713/150-B³⁾
- 713/260-L (-P)
- 713/276-LN¹⁾ (-PN¹⁾)
- 713/296-C
- 713/296-CC
- 713/296-L (-P)
- 713/300-LR (-PR)
- 713/300-LRV (-PRV)
- 713/317-LN¹⁾ (-PN¹⁾)
- 713/396-L (-P)
- 713/396-LH (-PH)
- 713/396-LV (-PV)
- 713/446-L (-P)
- 713/446-LH (-PH)
- 713/446-LSW (-PSW)
- 713/446-LV (-PV)
- 713/446-M
- 713/456-L (-P)
- 713/596-L (-P)
- 713/596-LH (-PH)
- 713/596-LV (-PV)
- 713/596-M
- 943/50-I
- 943/150-B³⁾
- 943/276-LN¹⁾ (-PN¹⁾)
- 943/296-L (-P)
- 943/296-LE
- 943/296-PE
- 943/300-LRV (-PRV)
- 943/396-L (-P)
- 943/396-LH (-PH)
- 943/396-LV (-PV)
- 943/446-L (-P)
- 943/446-LH (-PH)
- 943/446-LV (-PV)
- 943/596-L (-P)
- 943/596-LH (-PH)
- 943/596-LV (-PV)
- 1055/446-LH (-PH)
- 1055/446-LV (-PV)
- 1055/596-LV (-PV)
- 1081/446-L (-P)
- 1081/596-L (-P)
- 1198/50-I
- 1198/300-LRV (-PRV)
- 1247/296-CC
- 1247/446-L (-P)
- 1247/446-LSW (-PSW)
- 1247/596-L (-P)
- 1261/446-L (-P)
- 1261/446-LH (-PH)
- 1261/446-LV (-PV)
- 1261/596-L (-P)
- 1500/140-K

simplified door types



pattern u1
solid door
straight



pattern u2
routed solid
door

pattern u3
door panel with simple
routed motif



doors: 713/276-LN¹⁾ (-PN¹⁾) for cabinet GNW-60/72
 713/317-LN¹⁾ (-PN¹⁾) for cabinet DNW-90/82
 943/276-LN¹⁾ (-PN¹⁾) for cabinet GNW-60/95



have chamfered edge
left doors from the set 713/276-LN¹⁾

selection of characteristic door types



glazing



basic design

Gemma

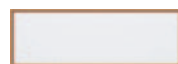

plain design

plain design
available doors:
250/446-SV
284/446-SV
284/596-SV
284/896-SV
284/896-VO

cornice and pelmet

cornices - pelmets dimensions see pages 76-77 >>>

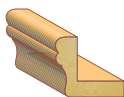

cornice **P**
colour **Honey Alder**
material **wood, MDF**
available length **1200, 2100, 2700 mm**



curved cornice **P**
material **wood, MDF**

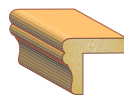

pelmet **P**
colour **Honey Alder**
material **wood, MDF**
available length **1200, 2100, 2700 mm**



curved pelmet **P**
material **wood, MDF**

1) set of doors for corner units (internal)
 3) decorative infill panel, p. 48



[16] DIADEMA XVI PIĘKNA

Royal 5

door colour **Dark Nut**
 material **wood (acacia), MDF, veneer**
 thickness **20 mm**
 glazing **Rosa factory fitted**
 lattice **Dark Nut factory fitted**
 carcass **Windsor Oak**
 cornice and pelmet **D**

also available in colours of the door



hoods p. 114-117

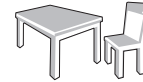

tables and chairs p. 120-121

available door types

- 75/596-B.....pattern u1
- 87/596-B.....pattern u1
- 110/596-K (-S).....pattern u1
- 140/146-S.....pattern u1
- 140/296-ST.....pattern u2
- 140/446-B.....pattern u2
- 140/446-ST.....pattern u2
- 140/596-B.....pattern u2
- 140/596-ST.....pattern u2
- 140/896-ST.....pattern u2
- 250/446-ST.....pattern u2
- 250/446-STH
- 250/446-STV
- 284/296-ST.....pattern u2
- 284/446-ST.....pattern u2
- 284/446-STH
- 284/446-STV
- 284/596-ST.....pattern u2
- 284/596-STH
- 284/596-STV
- 284/896-ST.....pattern u2
- 284/896-STH
- 284/896-STV
- 316/596-O
- 355/446-O
- 355/446-OH
- 355/446-VO
- 355/596-O
- 355/596-OH
- 355/596-VO
- 393/446-O
- 393/596-O
- 500/596-B
- 500/596-O
- 570/296-L (-P)
- 570/296-ST
- 570/446-L (-P)
- 570/446-M
- 570/446-ST
- 570/596-L (-P)
- 570/596-M
- 570/596-ST
- 643/596-L (-P)
- 713/146-CX.....pattern u2
- 713/150-B³⁾
- 713/260-L (-P)
- 713/276-LN¹⁾ (-PN¹⁾)
- 713/296-C
- 713/296-CC
- 713/296-L (-P)
- 713/300-LR (-PR)
- 713/300-LRV (-PRV)
- 713/317-LN¹⁾ (-PN¹⁾)
- 713/396-L (-P)
- 713/396-LH (-PH)
- 713/396-LV (-PV)
- 713/446-L (-P)
- 713/446-LH (-PH)
- 713/446-LSW (-PSW)
- 713/446-LV (-PV)
- 713/446-M
- 713/456-L (-P)
- 713/596-L (-P)
- 713/596-LH (-PH)
- 713/596-LV (-PV)
- 713/596-M
- 943/150-B³⁾
- 943/276-LN¹⁾ (-PN¹⁾)
- 943/296-L (-P)
- 943/300-LRV (-PRV)
- 943/396-L (-P)
- 943/396-LH (-PH)
- 943/396-LV (-PV)
- 943/446-L (-P)
- 943/446-LH (-PH)
- 943/446-LV (-PV)
- 943/596-L (-P)
- 943/596-LH (-PH)
- 943/596-LV (-PV)
- 1055/446-LH (-PH)
- 1055/446-LV (-PV)
- 1055/596-LV (-PV)
- 1081/446-L (-P)
- 1081/596-L (-P)
- 1198/300-LRV (-PRV)
- 1247/296-CC
- 1247/446-L (-P)
- 1247/446-LSW (-PSW)
- 1247/596-L (-P)
- 1261/446-L (-P)
- 1261/446-LH (-PH)
- 1261/446-LV (-PV)
- 1261/596-L (-P)
- 1500/140-K

simplified door types

selection of characteristic door types



pattern u1
solid door
straight



pattern u2
routed solid
door



1500/140-K (crown)

Please note: doors 284mm height have different routing patterns, full height doors do have u2 pattern, while doors with glazing and lattice have routing in wave form (basic).



284/596-S



284/596-SV



284/596-SH

doors: 713/276-LN¹⁾ (-PN¹⁾) for cabinet GNW-60/72
 713/317-LN¹⁾ (-PN¹⁾) for cabinet DNW-90/82
 943/276-LN¹⁾ (-PN¹⁾) for cabinet GNW-60/95



have chamfered edge

left doors from the set 713/276-LN¹⁾



713/300-LR (-PR)



713/300-LRV (-PRV)

glazing



basic design

Rosa



plain design

plain design
available doors:
250/446-SV
284/446-SV
284/596-SV
284/896-SV
355/446-LV (-PV)
355/596-LV (-PV)

cornice and pelmet

cornices - pelmets dimensions see pages 76-77 >>>

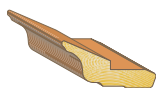

cornice **D**
colour **Dark Nut**
material **MDF, veneer**
available length **3000 mm**
curved cornice **D**
material **MDF, veneer**



pelmet **D**
colour **Dark Nut**
material **MDF, veneer**
available length **3600 mm**
curved pelmet **D**
material **wood, veneer**



1) set of doors for corner units (internal)
 3) decorative infill panel, p. 48

complete Royal 4 cabinets

up to height of **230 cm** + cornice

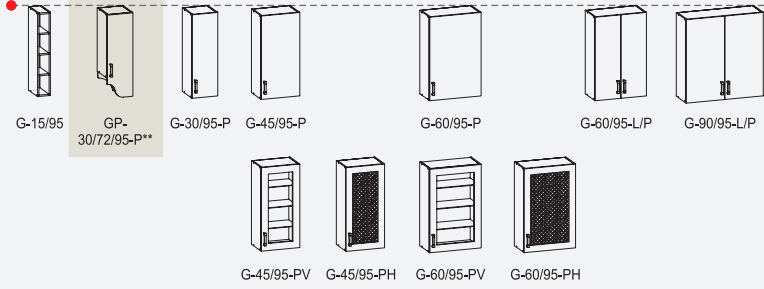

KORONA-150/14

dish drainers

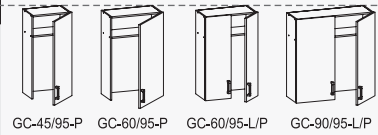

up to height **207 cm** + cornice

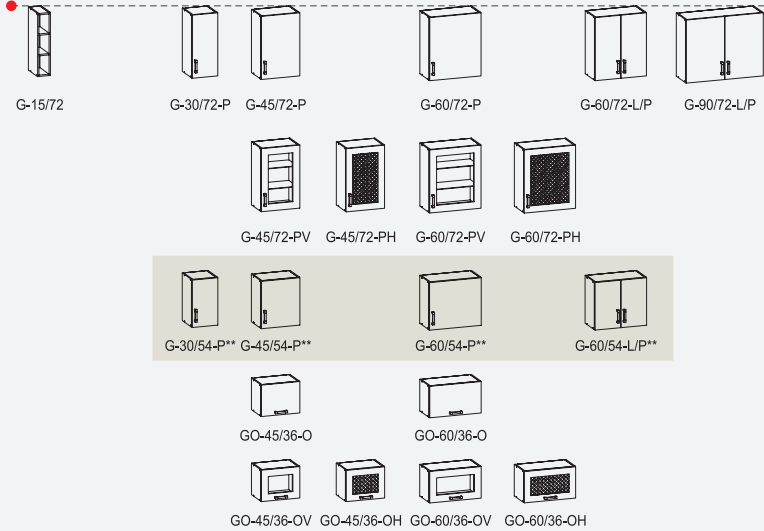

GB/4-90/72-LV/PV/B**

GB/4-90/72-LH/PH/B**

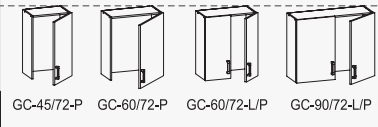

dish drainers

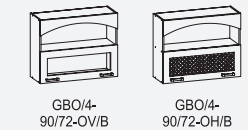

GBO/4-90/72-OV/B

GBO/4-90/72-OH/B



GS-30/15-2S GS-45/15-3S

up to height of **82 cm** + worktop

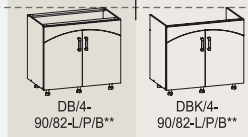
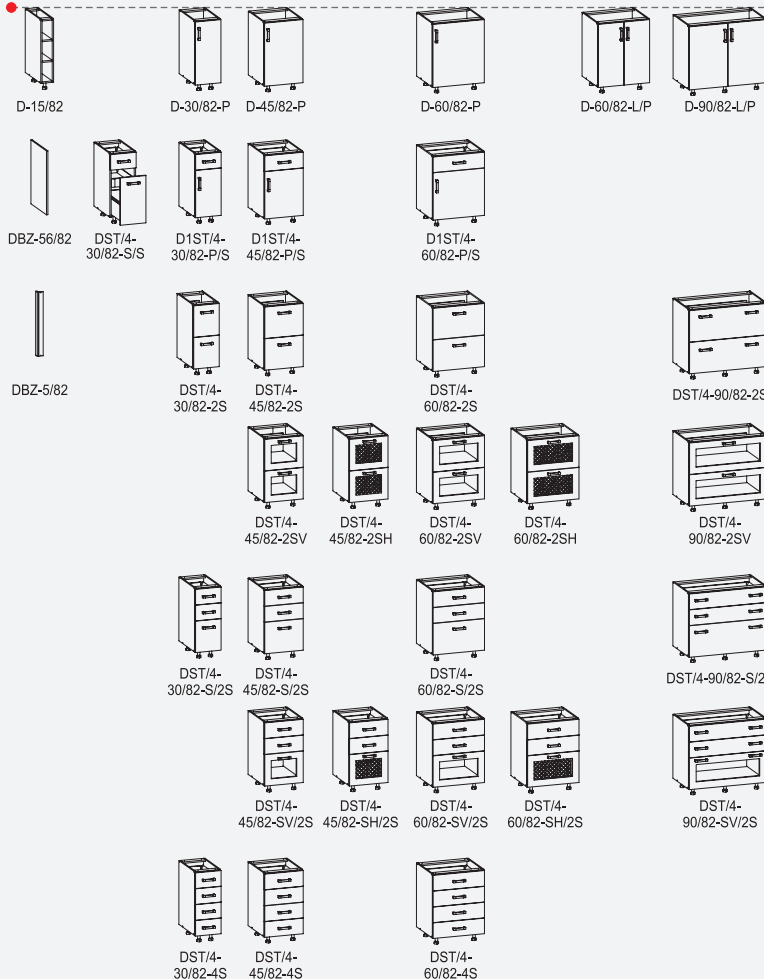

DB/4-90/82-L/P/B**

DBK/4-90/82-L/P/B**

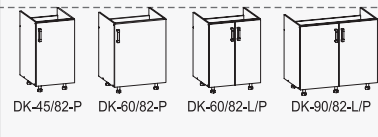

sink units

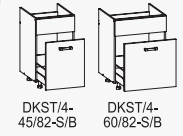

DKST/4-45/82-S/B DKST/4-60/82-S/B

sink units

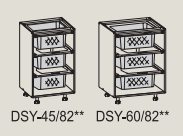

DSY-45/82** DSY-60/82**



corner units

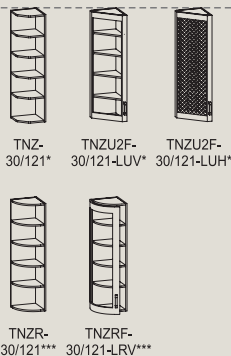
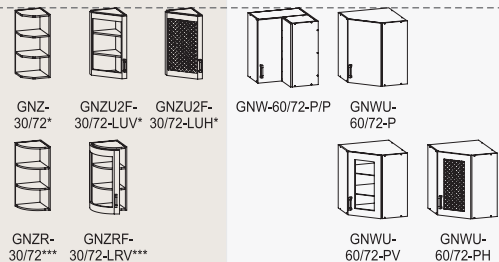
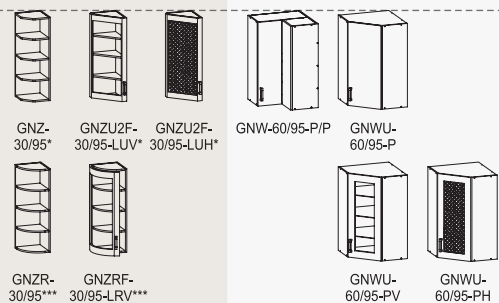

for housing domestic appliances

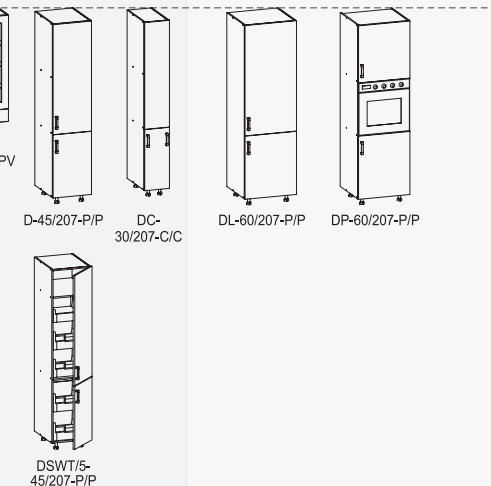
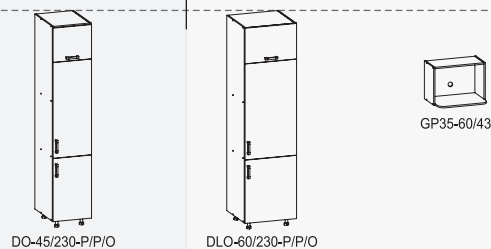

up to height of **143 cm** + worktop

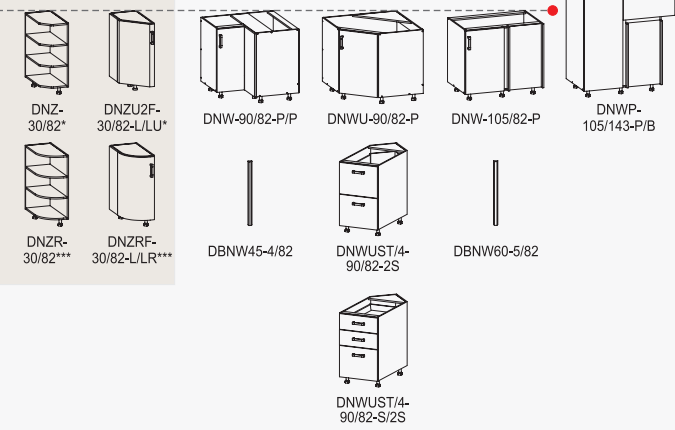

corner units

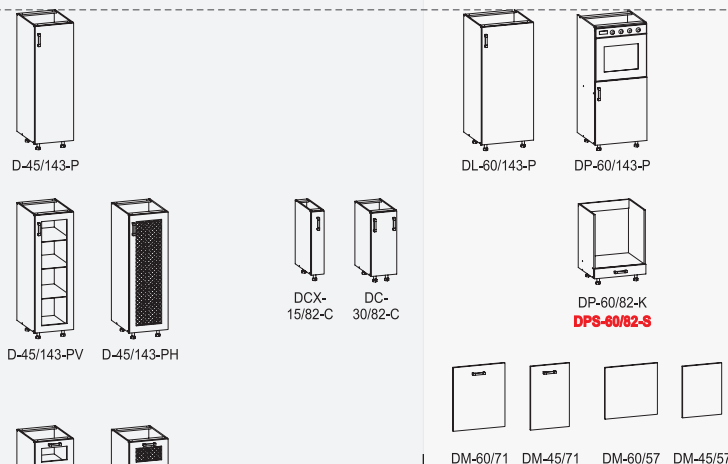

for housing domestic appliances

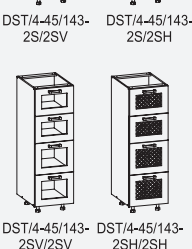

Royal 4

[11] STRATEGIO XI MĄDRY

[22] IMPEROR XXII ŁASKAWY

[25] TRONIUSZ XXV SPRAWIEDLIWY

* available in: [11] STRATEGIO XI Mądry

** available in: [22] IMPEROR XXII Łaskawy

*** available in: [22] IMPEROR XXII Łaskawy, [25] TRONIUSZ XXV Sprawiedliwy

complete Royal 5 cabinets

up to height of **230 cm** + cornice

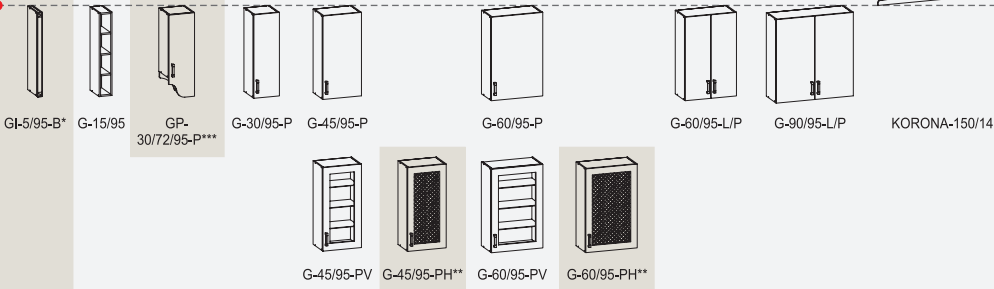

dish drainers

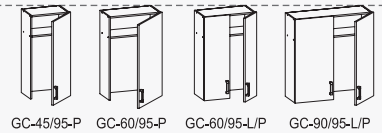

up to height of **207 cm** + cornice

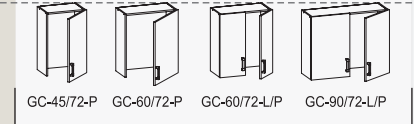
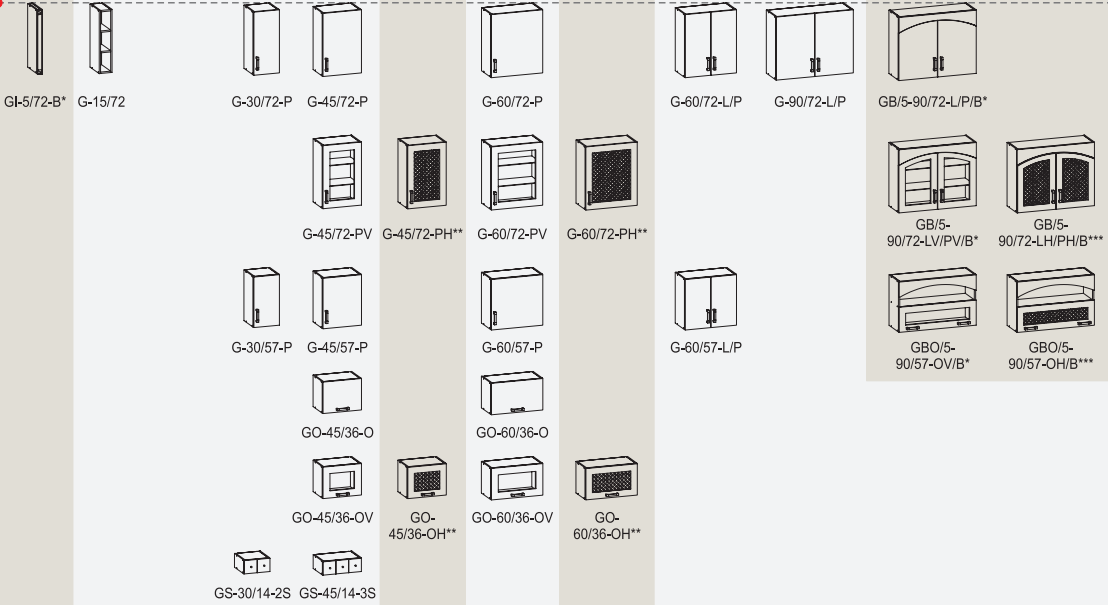

dish drainers

up to height of **82 cm** + worktop

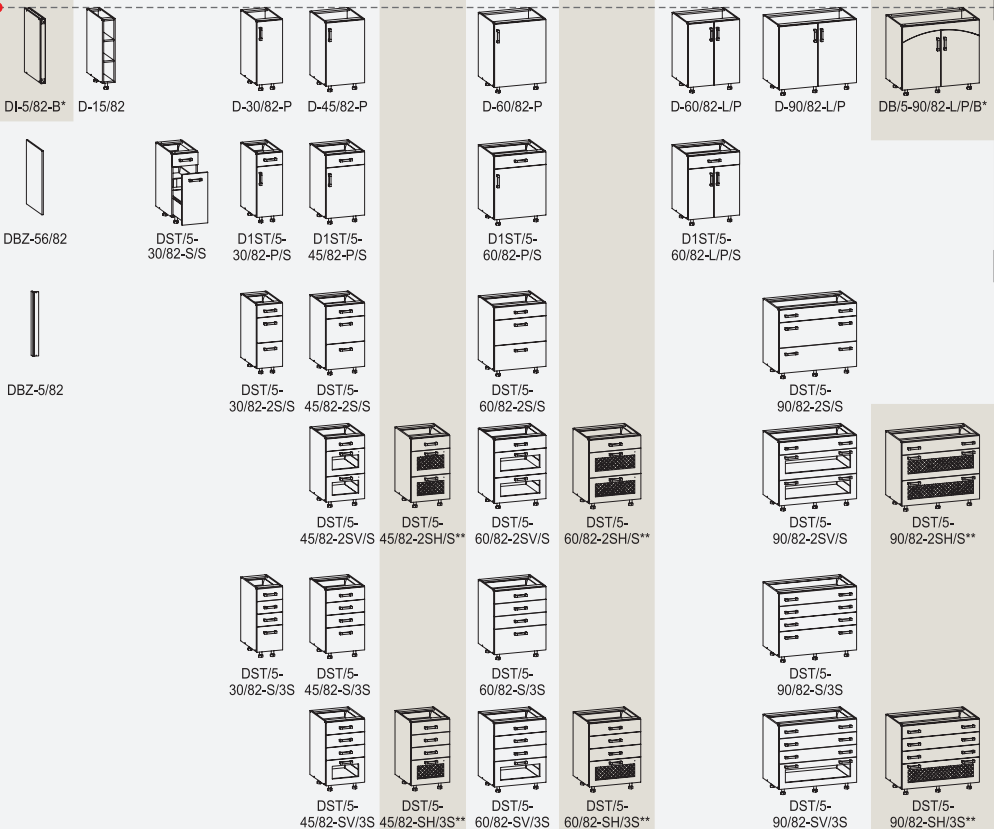

sink units

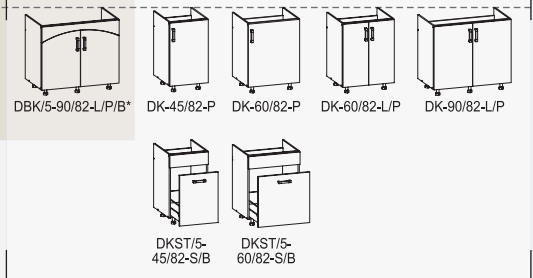

sink units

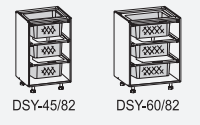

corner units

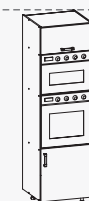
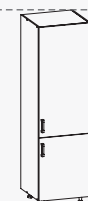
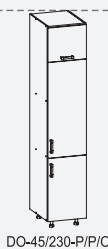
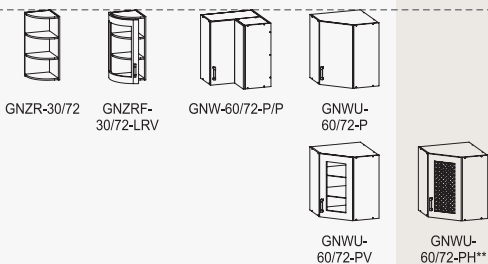
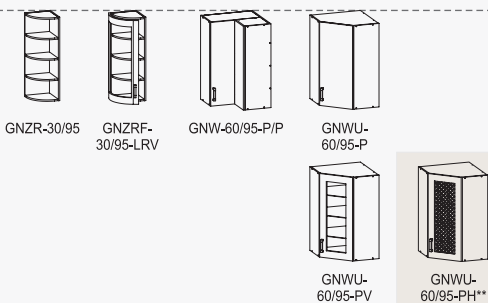

up to height of **136 cm** + worktop

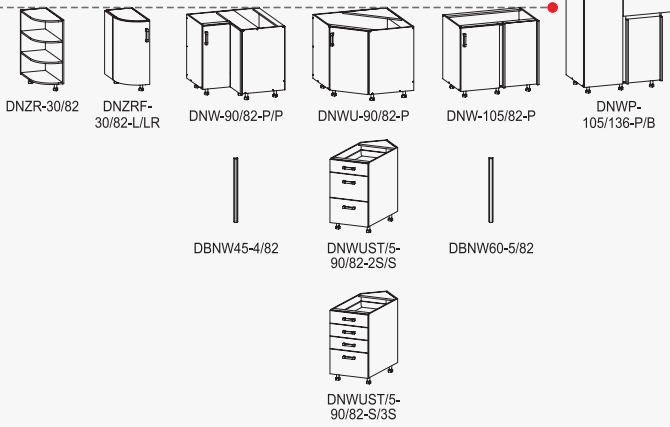

corner units

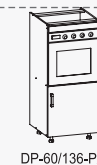
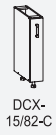
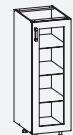

for housing domestic appliances

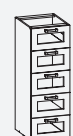

Royal 5

[14] INSYGNATA XIV DUMNA

[15] ARTYCJA XV DOBRA

[16] DIADEMA XVI PIĘKNA

* available in: [14] INSYGNATA XIV Dumna, [15] ARTYCJA XV Dobra

** available in: [15] ARTYCJA XV Dobra, [16] DIADEMA XVI Piękna

*** available in: [15] ARTYCJA XV Dobra



34th Avenue

doors type **EKRAN**
 door colour **Golden Alder**
 material **wood (alder), MDF, veneer**
 thickness **20 mm**
 glazing **Master, Frosted** factory fitted
 carcass **Portofino Cherry**
 cornice / pelmet **N**

CAPITAL 5

also available
in colours of the door



tables and chairs p. 120-121

available door types

75/596-B.....pattern u1
 87/596-B.....pattern u1
 110/596-K (-S).....pattern u2
 140/296-ST.....pattern u2
 140/446-B.....pattern u2
 140/446-ST.....pattern u2
 140/596-B.....pattern u2
 140/596-ST.....pattern u2
 140/896-ST.....pattern u2
 140/1196-ST.....pattern u2

250/446-ST
 250/446-STV
 284/296-ST
 284/446-ST
 284/446-STV
 284/596-ST
 284/596-STV
 284/896-ST
 284/896-STV
 284/1196-ST
 284/1196-STV

316/596-O
 355/446-O
 355/446-VO
 355/596-O
 355/596-VO
 355/896-O
 355/896-VO
 355/1196-O
 355/1196-VO
 393/446-O
 393/596-O

500/596-B
 500/596-O
 570/296
 570/296-ST
 570/446
 570/446-M
 570/446-ST
 570/596
 570/596-M
 570/596-ST

643/596

713/146-CXpattern u1
 713/150-B¹⁾
 713/276-N¹⁾
 713/296
 713/296-C
 713/296-CC
 713/296_446-U²⁾
 713/317-N¹⁾
 713/396
 713/396-V
 713/446
 713/446-LSW (-PSW)
 713/446-M
 713/446-V
 713/456
 713/466-UV
 713/596
 713/596-M
 713/596-V

943/150-B³⁾
 943/276-N¹⁾
 943/296
 943/396
 943/396-V
 943/446
 943/446-V
 943/466-UV
 943/596
 943/596-V

1055/446-V
 1055/596-V
 1081/446
 1081/596

1198/466-UV

1247/296-CC
 1247/446
 1247/446-LSW (-PSW)
 1247/596

1261/446
 1261/446-V
 1261/596

1) set of doors for corner units (internal)
 2) set of doors for corner units (external)
 3) decorative infill panel, p. 48

simplified door types

selection of characteristic door types

pattern u1

solid door straight



pattern u2

routed solid door



set of doors
713/296_446-U
for corner units (external)



713/466-UV



panel doors with
Master glass

713/466-UV



panel doors with
Frosted glass

glazing / aluminium frames

aluminium frames p. 19 >>>



Master (MA)

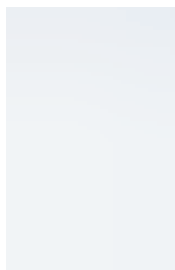

Frosted (ML)

A frame
with Master
glazing



A3 frame
with Master
glazing

aluminium frames

A frame
with Frosted
glazing



A3 frame
with Frosted
glazing

cornice / pelmet

cornice and pelmet dimensions are listed on page 76 >>>

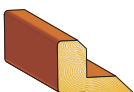

cornice / pelmet **N**
 colour **Elba Cherry**
 material **MDF, PVC foil**
 available length **2700 mm**



35th Avenue

doors type **EKRAN**
 door colour **Cherry**
 material **wood (alder), MDF, veneer, (cherry)**
 thickness **20 mm**
 glazing **Master, Frosted factory fitted**
 carcass **Elba Cherry**
 cornice / pelmet **N**

CAPITAL 5

also available
in colours of the door



tables and chairs p. 120-121

available door types

- 75/596-B.....pattern u1
- 87/596-B.....pattern u1
- 110/596-K (-S).....pattern u1
- 140/296-ST.....pattern u2
- 140/446-B.....pattern u2
- 140/446-ST.....pattern u2
- 140/596-B.....pattern u2
- 140/596-ST.....pattern u2
- 140/896-ST.....pattern u2
- 140/1196-ST.....pattern u2

- 250/446-ST
- 250/446-STV
- 284/296-ST
- 284/446-ST
- 284/446-STV
- 284/596-ST
- 284/596-STV
- 284/896-ST
- 284/896-STV
- 284/1196-ST
- 284/1196-STV

- 316/596-O
- 355/446-O
- 355/446-VO
- 355/596-O
- 355/596-VO
- 355/896-O
- 355/896-VO
- 355/1196-O
- 355/1196-VO
- 393/446-O
- 393/596-O

- 500/596-B
- 500/596-O
- 570/296
- 570/296-ST
- 570/446
- 570/446-M
- 570/446-ST
- 570/596
- 570/596-M
- 570/596-ST

643/596

- 713/146-CX.....pattern u1
- 713/150-B¹⁾
- 713/276-N¹⁾
- 713/296
- 713/296-C
- 713/296-CC
- 713/296_446-U²⁾
- 713/317-N¹⁾
- 713/396
- 713/396-V
- 713/446
- 713/446-LSW (-PSW)
- 713/446-M
- 713/446-V
- 713/456
- 713/466-UV
- 713/596
- 713/596-M
- 713/596-V

- 943/150-B³⁾
- 943/276-N¹⁾
- 943/296
- 943/396
- 943/396-V
- 943/446
- 943/446-V
- 943/466-UV
- 943/596
- 943/596-V

- 1055/446-V
- 1055/596-V
- 1081/446
- 1081/596

1198/466-UV

- 1247/296-CC
- 1247/446
- 1247/446-LSW (-PSW)
- 1247/596

- 1261/446
- 1261/446-V
- 1261/596

1) set of doors for corner units (internal)
 2) set of doors for corner units (external)
 3) decorative infill panel, p. 48

simplified door types

selection of characteristic door types

pattern u1

solid door straight



pattern u2

routed solid door



set of doors
713/296_446-U
for corner units (external)



713/466-UV



panel doors with
Master glass

713/466-UV



panel doors with
Frosted glass

glazing / aluminium frames

aluminium frames p. 19 >>>



Master (MA)

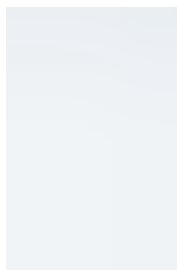

Frosted (ML)

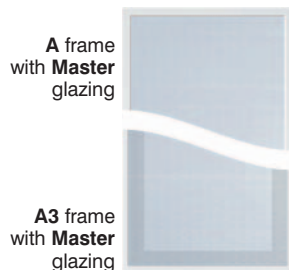

A frame
with Master
glazing

A3 frame
with Master
glazing



A frame
with Frosted
glazing

A3 frame
with Frosted
glazing

aluminium frames

cornice / pelmet

cornice and pelmet dimensions are listed on page 76 >>>

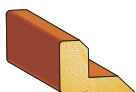

cornice / pelmet **N**
 colour **Elba Cherry**
 material **MDF, PVC Foil**
 available length **2700 mm**



36th Avenue

doors type TAFLA
 door colour Cherry
 material chipboard, veneer (cherry),
 glued on wood (alder)
 thickness 20 mm
 glazing Master, Frosted (only in aluminium frames)
 carcass Elba Cherry
 cornice / pelmet **N**

CAPITAL 5

also available
 in colours of the door



tables and chairs p. 120-121

available door types

75/596-B
 87/596-B
 110/596-K (-S)
 140/296-ST
 140/446-B
 140/446-ST
 140/596-B
 140/596-ST
 140/896-ST
 140/1196-ST
 250/446-ST
 284/296-ST
 284/446-ST
 284/596-ST
 284/896-ST
 284/1196-ST

joining doors

The 36th Avenue group do not have a glass doors in this range, however there is possibility to combine the doors from 36th Avenue with 35th Avenue group.



36th Avenue
 full door



35th Avenue
 glass window

316/596-O
 355/446-O
 355/596-O
 355/896-O
 355/1196-O
 393/446-O
 393/596-O
 500/596-B
 500/596-O
 570/296
 570/296-ST
 570/446
 570/446-M
 570/446-ST
 570/596
 570/596-M
 570/596-ST
 643/596
 713/146-CX
 713/150-B³⁾
 713/276-N¹⁾
 713/296
 713/296-C
 713/296-CC
 713/317-N¹⁾
 713/396
 713/446
 713/446-LSW (-PSW)
 713/446-M
 713/456
 713/466-U
 713/596
 713/596-M
 943/150-B³⁾
 943/276-N¹⁾
 943/296
 943/396
 943/446
 943/596

aluminium frames

aluminium frames p. 19 >>>



aluminium frames

1081/446
 1081/596
 1247/296-CC
 1247/446
 1247/446-LSW (-PSW)
 1247/596
 1261/446
 1261/596

1) set of doors for corner units (internal)
 3) decorative infill panel, p. 48

cornice / pelmet

cornice and pelmet dimensions are listed on page 76 >>>

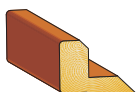

cornice / pelmet **N**
 colour Elba Cherry
 material MDF, PVC Foil
 available length 2700 mm

aluminium frames A



with **Master (MA)** glazing

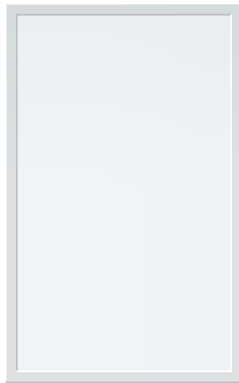

with **Frosted (ML)** glazing

door type **A**
 door colour **aluminium**
 material **aluminium**
 thickness **21 mm**
 frame width **18 mm**
 glazing **Master, Frosted factory fitted**
 In A frames holes are drilled for single point handles

CAPITAL

TRAFFIC

Modern LINE

BRW LINE
modern doors

aluminium frames available

- 355/446-VO
- 355/596-VO
- 355/896-VO
- 355/1196-VO
- 713/446-V
- 713/596-V
- 943/446-V
- 943/596-V
- 1198/446-V
- 1198/596-V
- 1261/446-V

manner of attaching handles

horizontal doors in mid width
 excepting doors 355/1196-OV,
 where two handles are attached

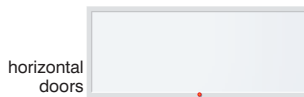

horizontal doors

vertical doors in mid height

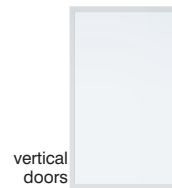

vertical doors

suggested handles compatible with aluminium frames A



handle characteristics p. 81 >>>

aluminium frames A3



with **Master (MA)** glazing

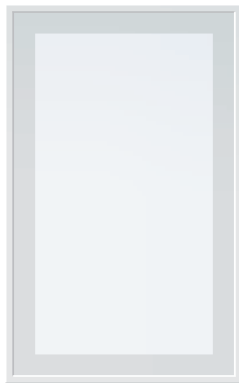

with **Frosted (ML)** glazing

door type **A3**
 door colour **aluminium**
 material **aluminium**
 thickness **21 mm**
 frame width **45 mm (10 mm)**
 glazing **Master, Frosted factory mounted**
 in A3 frames holes are drilled for the handle
 160 mm apart

CAPITAL

TRAFFIC

Modern LINE

BRW LINE
modern doors

available aluminium frames

- 355/446-VO
- 355/596-VO
- 355/896-VO
- 355/1196-VO
- 713/446-LV
- 713/446-PV
- 713/596-LV
- 713/596-PV
- 943/446-LV
- 943/446-PV
- 943/596-LV
- 943/596-PV
- 1198/446-LV
- 1198/446-PV
- 1198/596-LV
- 1198/596-PV
- 1261/446-LV
- 1261/446-PV

handles attachment

horizontal doors in mid width
 vertical doors with vertical laminate grain pattern in mid height excepting doors 1261/446-LV (-PV) - for lower cabinets, where the handles are attached in the upper part of the door

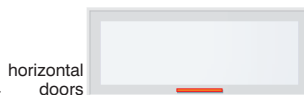

horizontal doors

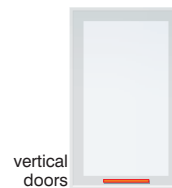

vertical doors

suggested selection of handles compatible with aluminium frames A3

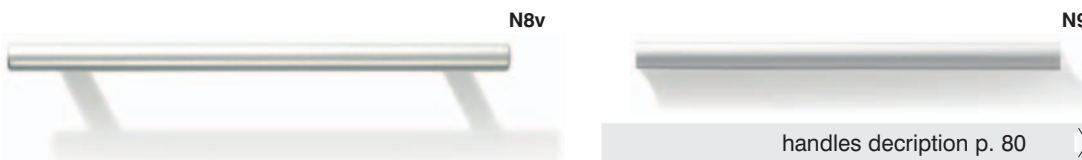

handles decription p. 80 >>>

up to height of **230 cm** + cornice

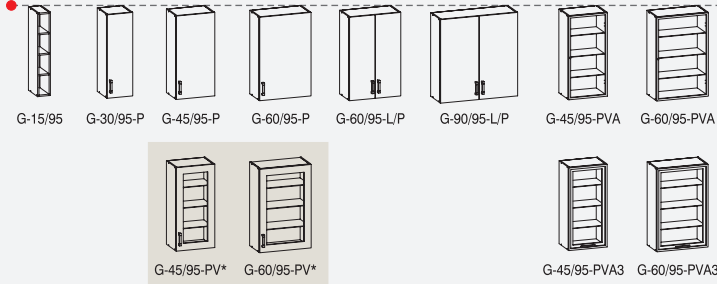

dish drainers

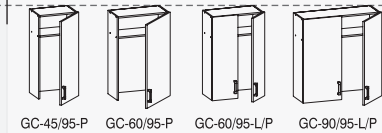

corner units

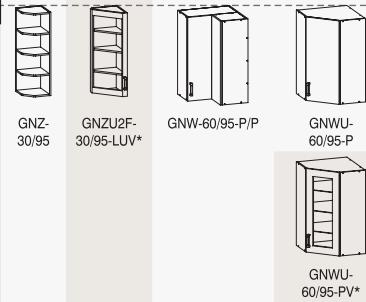

up to height of **207 cm** + cornice

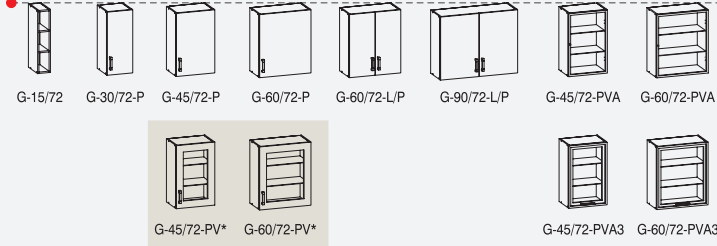

dish drainers

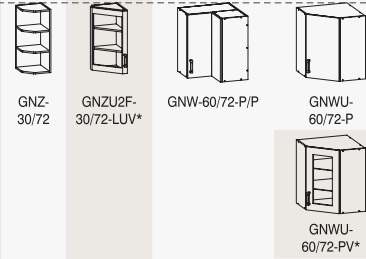
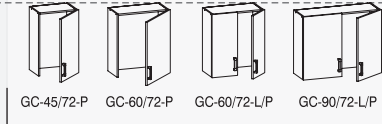

up to height of **82 cm** + worktop

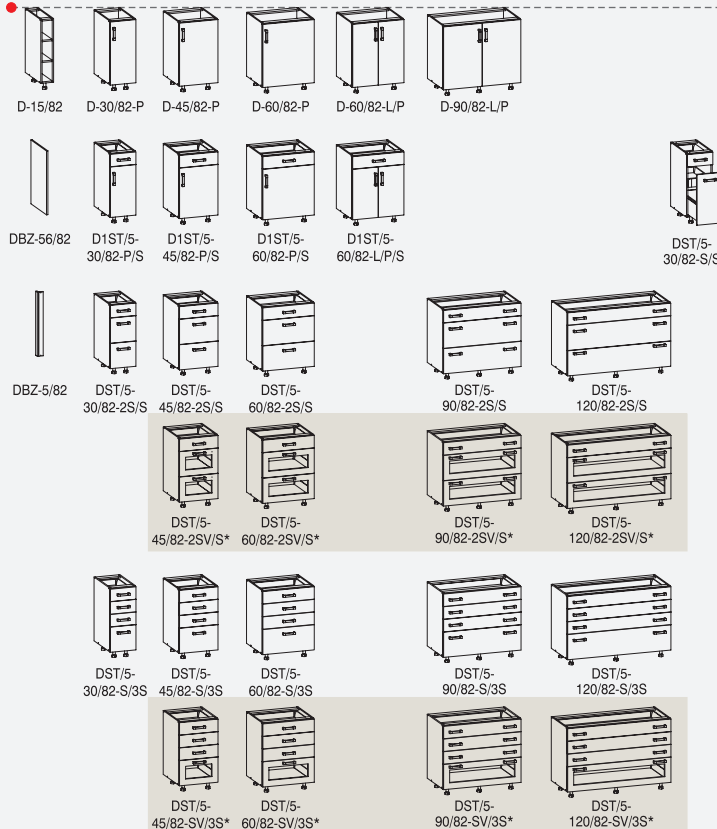

sink units

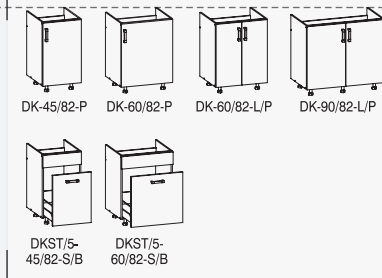

sink units

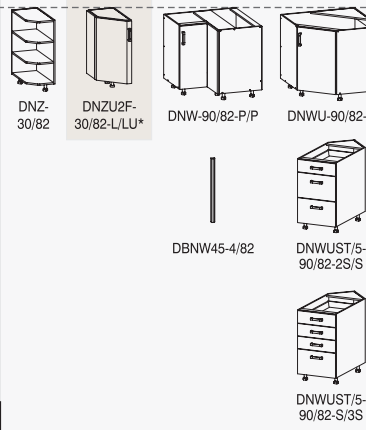

corner units



for housing domestic appliances



G20-60/72-2O G20-90/72-2O



G20-60/72-2OV* G20-90/72-2OV*

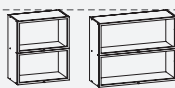

G20-60/72-2OVA G20-90/72-2OVA

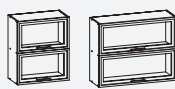

G20-60/72-2OVA3 G20-90/72-2OVA3



GO-45/36-O GO-60/36-O GO-90/36-O GO-120/36-O



GO-45/36-OVA GO-60/36-OVA GO-90/36-OVA GO-120/36-OVA



GO-45/36-OV* GO-60/36-OV* GO-90/36-OV* GO-120/36-OV*



GO-45/36-OVA3 GO-60/36-OVA3 GO-90/36-OVA3 GO-120/36-OVA3



TNZ-30/121



TROL-60/121
TROL-60/121 STAL



DO-45/230-P/P/O



DLO-60/230-P/P/O



GOO-60/50-O



GP35-60/43



TNZU2F-30/121-LUV*



TST/5-45/121-S/PV*



TST/5-60/121-S/PV*



T-45/121-PVA



T-60/121-PVA



T-45/121-PVA3

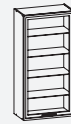

T-60/121-PVA3



D-45/207-P/P

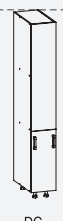

DC-30/207-C/C



DL-60/207-P/P



DP-60/207-P/P



DPP450-60/207-P/O

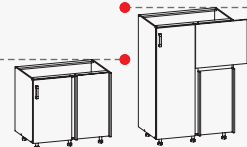

DNW-105/82-P DNWP-105/136-P/B

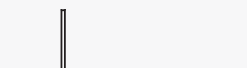

DBNW60-5/82



D-45/136-P



D-45/136-PVA

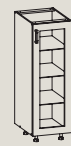

D-45/136-PV*



D-45/136-PVA3



DCX-15/82-C



DC-30/82-C



DL-60/136-P



DP-60/136-P/B

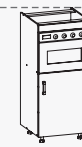

DP45-60/136-P/B



DP-60/82-K
DPS-60/82-S



DM-60/71



DM-45/71



DM-60/57



DM-45/57

for housing domestic appliances



DST/5-45/136-SS



DST/5-45/136-SSV*

CAPITAL

34th Avenue
35th Avenue
36th Avenue

* available in: 34th Avenue, 35th Avenue



[3P] *Trzy Łyczenia Patyna*

doors type RAMA
 door colour Honey Alder Patina
 material MDF, PVC foil, lacquer
 thickness 20 mm
 glazing Clear with Strip, Rough factory fitted
 carcass San Alder
 cornice and pelmet **A**



[9] *Dziękuję Symfonia*

doors type RAMA
 door colour Nut Patina
 material MDF, PVC foil, lacquer
 thickness 20 mm
 glazing Clear with Strip, Rough factory fitted
 carcass Windsor Oak
 cornice and pelmet **A**

simplified door and pilaster patterns in [3]P

simplified door and pilaster patterns in [9]



pattern u1
door without panel



713/50-1 (pilaster)



pattern u2
door with shallow panel



pattern u1
door without panel



713/50-1 (pilaster)



pattern u2
door with shallow panel

glazing

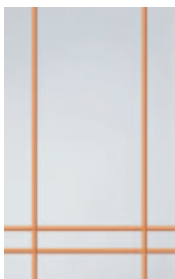

Clear with Strip (CL)



Rough (MR)

cornice and pelmet for doors [3]P

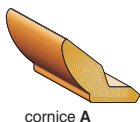

cornice A

cornice and pelmet **A**
 colour Honey Alder Patina
 material MDF, PVC foil,
 lacquer

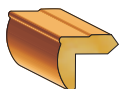

pelmet A

available length 2700 mm

cornice and pelmet for doors [9]

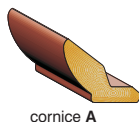

cornice A

cornice and pelmet **A**
 colour Nut Patina
 material MDF, PVC foil, lacquer
 available length 2700 mm



pelmet A

Sentima 5

available door types

- 75/596-B.....pattern u1
- 87/596-B.....pattern u1
- 110/596-K (-S).....pattern u1
- 140/146-S.....pattern u1
- 140/296-SMpattern u2
- 140/446-B.....pattern u2
- 140/446-SM.....pattern u2
- 140/596-B.....pattern u2
- 140/596-SM.....pattern u2
- 140/896-SM.....pattern u2
- 250/446-SM
- 250/446-SMV
- 284/296-SM
- 284/446-SM
- 284/596-SM
- 284/896-SM
- 284/896-SMV
- 316/596-O
- 355/446-O
- 355/446-VO
- 355/496-O
- 355/596-O
- 355/596-VO
- 393/446-O
- 393/596-O
- 500/596-B
- 500/596-O
- 570/296
- 570/296-SM
- 570/446
- 570/446-M
- 570/446-SM
- 570/596
- 570/596-M
- 570/596-SM
- 643/596
- 713/50-I
- 713/146-CXpattern u1
- 713/284-N¹⁾
- 713/296
- 713/296-C
- 713/296-CC
- 713/296-Z²⁾
- 713/325-N¹⁾
- 713/396
- 713/396-V (-LV, -PV)
- 713/430-V (-LV, -PV)
- 713/446
- 713/446-M
- 713/446-V (-LV, -PV)
- 713/456
- 713/596
- 713/596-M
- 713/596-V (-LV, -PV)
- 943/50-I
- 943/284-N¹⁾
- 943/296
- 943/396
- 943/396-V (-LV, -PV)
- 943/430-V (-LV, -PV)
- 943/446
- 943/446-V (-LV, -PV)
- 943/596
- 943/596-V (-LV, -PV)
- 1055/446-V (-LV, -PV)
- 1055/596-V (-LV, -PV)
- 1081/446
- 1081/596
- 1198/50-I
- 1247/296-CC
- 1247/446
- 1247/596
- 1261/446
- 1261/446-V (-LV, -PV)
- 1261/596

1) set of doors for corner units (internal)
 2) set of doors for corner units (external)



[4] *Extery Pony Roku*

Sentima 5

doors type **KARTA** same door pattern is available in **BRW Line** group (KARTA 127) p. 41
 door colour **Dark Vanilla**
 material **MDF, PVC foil**
 thickness **16 mm**
 glazing **Clear, Rough, Frosted with an Ellipse** installed on site
 carcasses **Beech, Windsor Oak, San Alder, Electra Cherry**
 cornice and pelmet **A**

available door types

- 75/596-B.....pattern u1
 - 87/596-B.....pattern u1
 - 110/596-K (-S).pattern u2
 - 140/146-S.....pattern u1
 - 140/296-SM.....pattern u2
 - 140/446-B.....pattern u2
 - 140/446-SM.....pattern u2
 - 140/596-B.....pattern u2
 - 140/596-SM.....pattern u2
 - 140/896-E
 - 140/896-SM.....pattern u2
 - 250/446-SM.....pattern u3
 - 250/446-SMV
 - 284/296-SM.....pattern u3
 - 284/446-SM.....pattern u3
 - 284/596-SM.....pattern u3
 - 284/896-SM.....pattern u3
 - 284/896-SMV
 - 284/896-VO
 - 316/596-O
 - 355/446-O
 - 355/446-VO
 - 355/496-O
 - 355/596-O
 - 355/596-VO
 - 393/446-O
 - 393/596-O
 - 426/446
 - 500/596-B
 - 500/596-O
 - 570/296
 - 570/296-SM
 - 570/446
 - 570/446-M
 - 570/446-SM
 - 570/596
 - 570/596-M
 - 570/596-SM
 - 620/446-LE
 - 620/446-LVE
 - 620/446-PE
 - 620/446-PVE
 - 643/596
 - 713/50-I
 - 713/146-CXpattern u1
 - 713/280-N¹⁾
 - 713/296
 - 713/296-C
 - 713/296-CC
 - 713/296-Z²⁾
 - 713/321-N¹⁾
 - 713/396
 - 713/396-V
 - 713/430-V
 - 713/446
 - 713/446-M
 - 713/446-V
 - 713/456
 - 713/596
 - 713/596-M
 - 713/596-V
 - 943/50-I
 - 943/280-N¹⁾
 - 943/296
 - 943/296-LE
 - 943/296-PE
 - 943/396
 - 943/396-V
 - 943/430-V
 - 943/446
 - 943/446-V
 - 943/596
 - 943/596-V
 - 1055/446-V
 - 1055/596-V
 - 1081/446
 - 1081/596
 - 1198/50-I
 - 1247/296-CC
 - 1247/446
 - 1247/596
 - 1261/446
 - 1261/446-V
 - 1261/596
 - 1500/140-K
- 1) set of doors for corner units (internal)
 2) set of doors for corner units (external)
- KARTA type doors available in colour Honey Alder or Antique Nut
- 284/896-SMV
 284/896-VO

simplified door types

pattern u1 rounded edge door

pattern u2 door with reduced frame and routing profile

pattern u3 door with reduced routing profile

selection of characteristic door types



glazing



Clear (CZ)



Rough (MR)



basic design



plain design

Frosted with an Ellipse (ME)

plain design available doors:
 250/446-SV
 284/896-SV
 284/896-VO

glass sizes and indices see page 49 >>>

cornice and pelmet

for available cornices and pelmets, see page 76 for details >>>

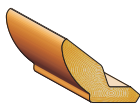

cornice A



pelmet A

cornice and pelmet **A**
 colour **Beech, Windsor Oak, San Alder, Electra Cherry**
 material **MDF, PVC foil**
 available length **2700 mm**



[7] *Siedme Niebo*

Sentima 5

doors type **FALA** same door pattern is available in **BRW Line group** (FALA 133) p. 42
 door colour **Honey Alder**
 material **MDF, PVC foil**
 thickness **16 mm**
 glazing **Clear, Rough, Frosted with an Ellipse** installed on site
 carcass **San Alder**
 cornice and pelmet **A**

available door types

- 75/596-Bpattern u1
- 87/596-Bpattern u1
- 110/596-Kpattern u1
- 140/146-Spattern u1
- 140/296-SMpattern u2
- 140/446-Bpattern u2
- 140/446-SMpattern u2
- 140/596-Bpattern u2
- 140/596-SMpattern u2
- 140/896-E
- 140/896-SMpattern u2

- 250/446-SM
- 250/446-SMV
- 284/296-SM
- 284/446-SM
- 284/596-SM
- 284/896-SM
- 284/896-SMV
- 284/896-VO

- 316/596-O
- 355/446-O
- 355/446-VO
- 355/496-O
- 355/596-O
- 355/596-VO
- 393/446-O
- 393/596-O

- 500/596-B
- 500/596-O
- 570/296-L (-P)
- 570/296-SM
- 570/446-L (-P)
- 570/446-M
- 570/446-SM
- 570/596-L (-P)
- 570/596-M
- 570/596-SM

- 615/446-LE
- 615/446-LVE
- 615/446-PE
- 615/446-PVE
- 643/596-L (-P)

- 713/50-I
- 713/146-CXpattern u1
- 713/280-LN¹⁾ (-PN¹⁾)
- 713/296-C
- 713/296-CC
- 713/296-L (-P)
- 713/296-LZ²⁾ (-PZ²⁾)
- 713/321-LN¹⁾ (-PN¹⁾)
- 713/396-L (-P)
- 713/396-LV (-PV)
- 713/430-LV (-PV)
- 713/446-L (-P)
- 713/446-LV (-PV)
- 713/446-M
- 713/456-L (-P)
- 713/596-L (-P)
- 713/596-LV (-PV)
- 713/596-M

- 943/50-I
- 943/280-LN¹⁾ (-PN¹⁾)
- 943/296-L (-P)
- 943/296-LE
- 943/296-PE
- 943/396-L (-P)
- 943/396-LV (-PV)
- 943/430-LV (-PV)
- 943/446-L (-P)
- 943/446-LV (-PV)
- 943/596-L (-P)
- 943/596-LV (-PV)

- 1055/446-LV (-PV)
- 1055/596-LV (-PV)
- 1081/446-L (-P)
- 1081/596-L (-P)

- 1198/50-I
- 1247/296-CC
- 1247/446-L (-P)
- 1247/596-L (-P)

- 1261/446-L (-P)
- 1261/446-LV (-PV)
- 1261/596-L (-P)

1500/140-K

1) set of doors for corner units (internal)
 2) set of doors for corner units (external)

simplified door types



pattern u1
rounded edge door



pattern u2
door with reduced frame and routing profile

selection of characteristic door types

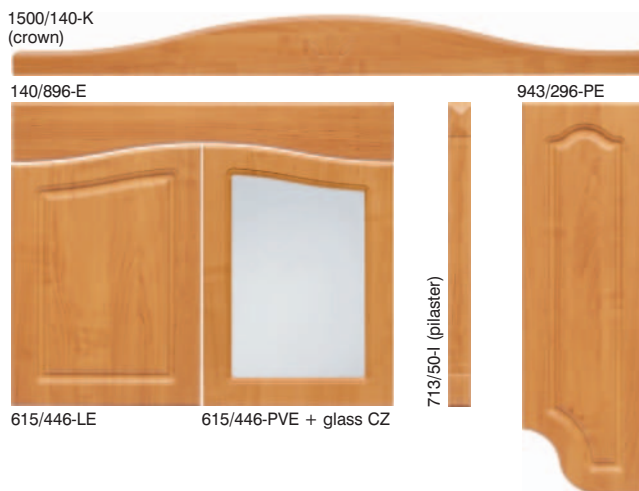

1500/140-K (crown)

140/896-E

943/296-PE

615/446-LE

615/446-PVE + glass CZ

713/50-I (pilaster)

glazing

glass sizes and indices see page 49 >>>



Clear (CZ)



Rough (MR)



basic design

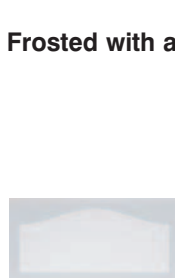

plain design

Frosted with an Ellipse (ME)

plain design available doors:

- 250/446-SV
- 284/896-SV
- 284/896-VO

cornice and pelmet

for available cornices and pelmets, see page 76 for details >>>



cornice A



pelmet A

cornice and pelmet **A**
 colour **San Alder**
 material **MDF, PVC foil**
 available length **2700 mm**



[12]P *Tuxin Róxi Patyna*

doors type **ARKADA**
 door colour **Korean Cherry Patina**
 material **MDF, PVC foil, lacquer**
 thickness **16 mm**
 glazing **Clear, Rough, Frosted with an Ellipse installed on site**
 carcass **Electra Cherry**
 cornice and pelmet **A**

Sentima 5

available door types

- 75/596-Bpattern u1
- 87/596-Bpattern u1
- 110/596-Kpattern u1
- 140/146-Spattern u1
- 140/296-SMpattern u2
- 140/446-Bpattern u2
- 140/446-SMpattern u2
- 140/596-Bpattern u2
- 140/596-SMpattern u2
- 140/896-E
- 140/896-SMpattern u2
- 250/446-SM
- 250/446-SMV
- 284/296-SM
- 284/446-SM
- 284/596-SM
- 284/896-SM
- 284/896-SMV
- 284/896-VO

- 316/596-O
- 355/446-O
- 355/446-VO
- 355/496-O
- 355/596-O
- 355/596-VO
- 393/446-O
- 393/596-O

- 500/596-B
- 500/596-O
- 570/296-L (-P)
- 570/296-SM
- 570/446-L (-P)
- 570/446-M
- 570/446-SM
- 570/596-L (-P)
- 570/596-M
- 570/596-SM

- 620/446-LE
- 620/446-LVE
- 620/446-PE
- 620/446-PVE
- 643/596-L (-P)

- 713/50-I
- 713/146-CXpattern u1
- 713/280-LN⁽¹⁾ (-PN⁽¹⁾)
- 713/296-C
- 713/296-CC
- 713/296-L (-P)
- 713/296-LZ⁽²⁾ (-PZ⁽²⁾)
- 713/321-LN⁽¹⁾ (-PN⁽¹⁾)
- 713/396-L (-P)
- 713/396-LV (-PV)
- 713/430-LV (-PV)
- 713/446-L (-P)
- 713/446-LV (-PV)
- 713/446-M
- 713/456-L (-P)
- 713/596-L (-P)
- 713/596-LV (-PV)
- 713/596-M

- 943/50-I
- 943/280-LN⁽¹⁾ (-PN⁽¹⁾)
- 943/296-L (-P)
- 943/296-LE
- 943/296-PE
- 943/396-L (-P)
- 943/396-LV (-PV)
- 943/430-LV (-PV)
- 943/446-L (-P)
- 943/446-LV (-PV)
- 943/596-L (-P)
- 943/596-LV (-PV)

- 1055/446-LV (-PV)
- 1055/596-LV (-PV)
- 1081/446-L (-P)
- 1081/596-L (-P)

1198/50-I

- 1247/296-CC
- 1247/446-L (-P)
- 1247/596-L (-P)

- 1261/446-L (-P)
- 1261/446-LV (-PV)
- 1261/596-L (-P)

1500/140-K

- 1) set of doors for corner units (internal)
- 2) set of doors for corner units (external)

simplified door types

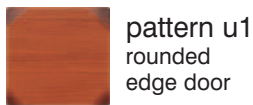

selection of characteristic door types

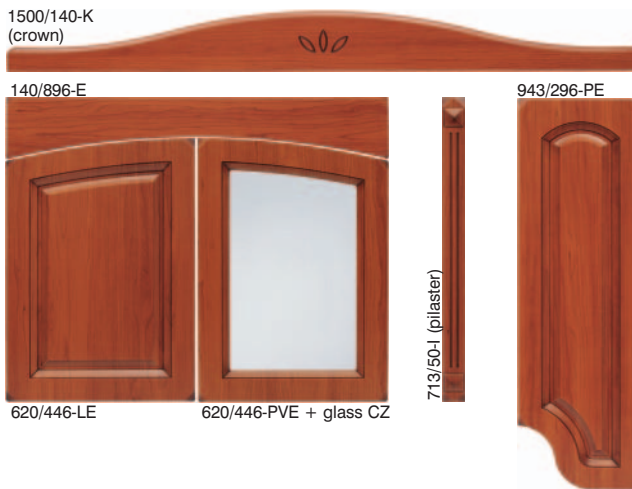

glazing



glass sizes and indices see page 49 >>>

Frosted with an Ellipse (ME)

plain design available doors:

- 250/446-SV
- 284/896-SV
- 284/896-VO

cornice and pelmet

for available cornices and pelmets, see page 76 for details >>>

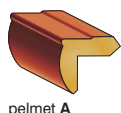
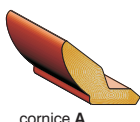

cornice and pelmet **A**
 colour **Korean Cherry Patina**
 material **MDF, PVC foil, lacquer**
 available length **2700 mm**

up to height of **230 cm** + cornice

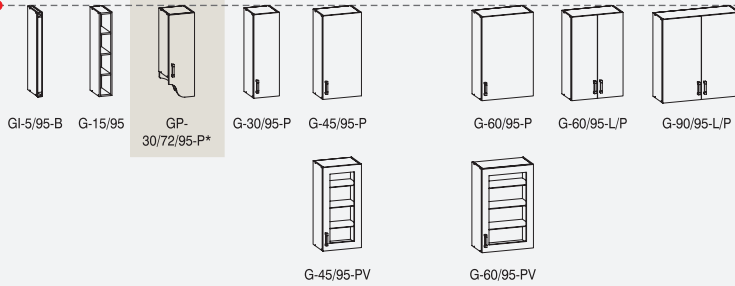

dish drainers

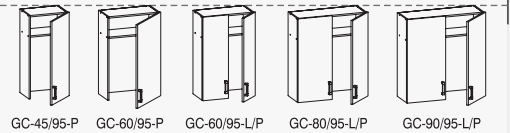

up to height of **207 cm** + cornice

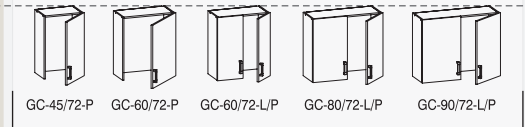
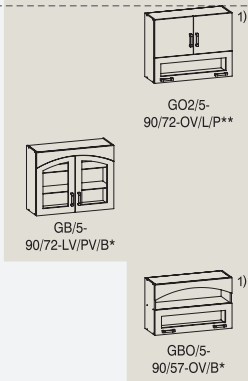
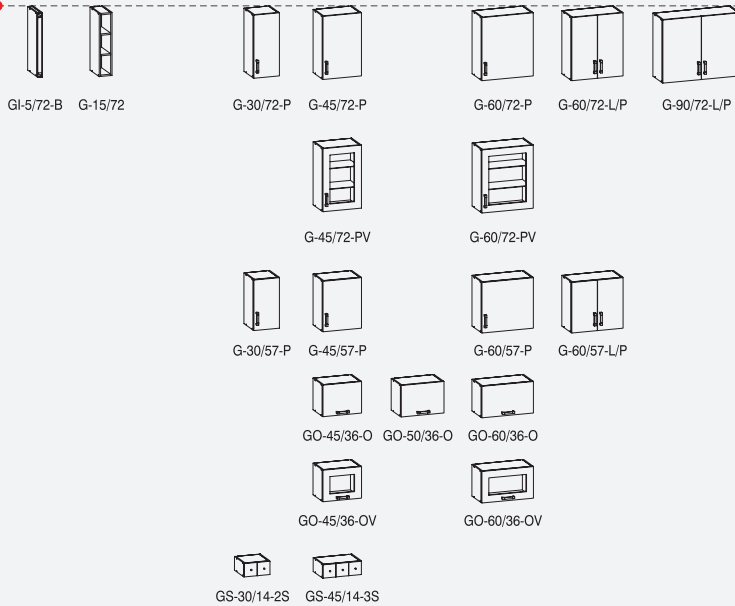

dish drainers

up to height of **82 cm** + worktop

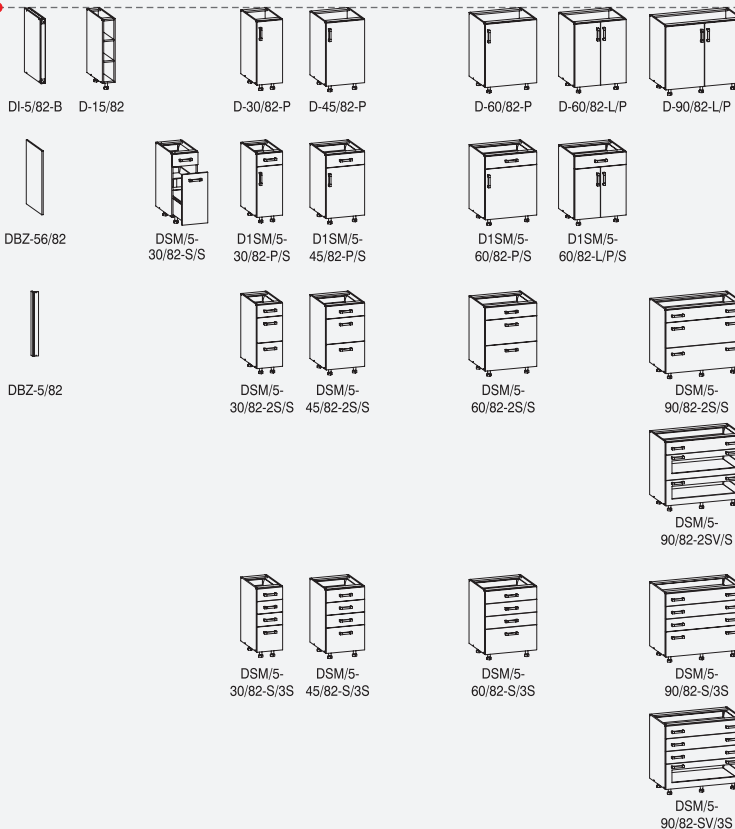

sink units

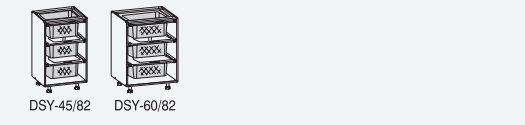

sink units



corner units

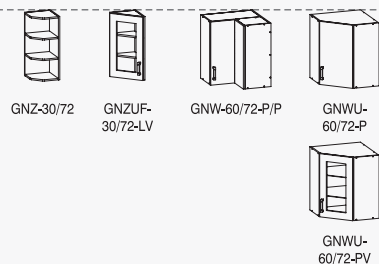
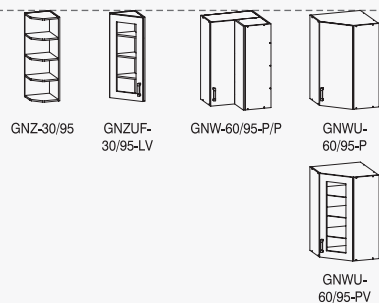

for housing domestic appliances

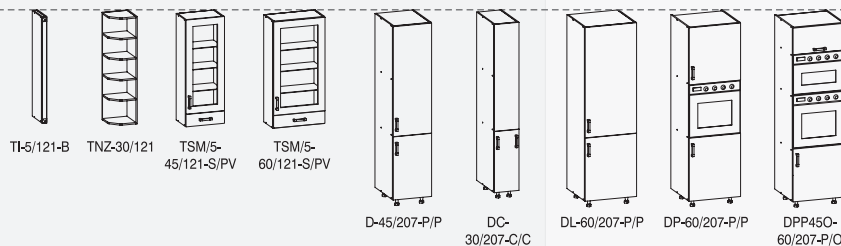
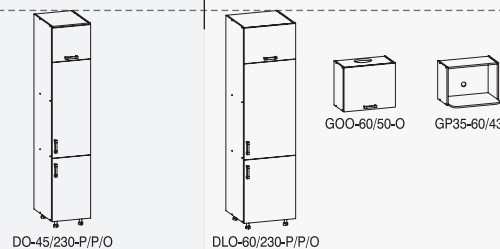

up to height of **136 cm** + worktop

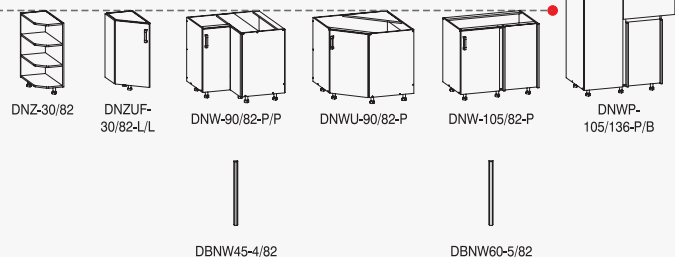

corner units

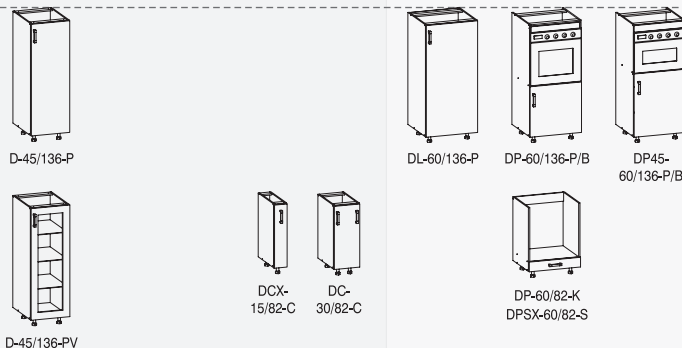

for housing domestic appliances

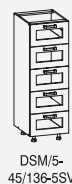
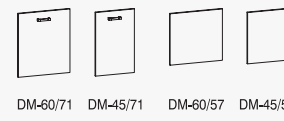

Sentima

[3P] *Trzy Łyczenia Piłtyna*

[4] *Cztery Pory Roku*

[7] *Siódme Niebo*

[9] *Dziwiasza Symfonia*

[12P] *Tuzin Róż Piłtyna*

* available in: [4] Cztery Pory Roku, [7] Siódme Niebo, [12] Tuzin Róż
** available in: [4] Cztery Pory Roku
1) in kitchen [4] Cztery Pory Roku door with window is also available with colours Honey Alder and Antique Nut

TRAFFIC 5

available door types



41st Milk Street

46th Sesame Street

door type TAFLA
 door colour Vanilla^[41], Cherry^[46]
 material chipboard, laminate
 thickness 18 mm
 glazing Master, Frosted (only in aluminium frames)
 carcasses Beech^[41], Windsor Oak^[41], San Alder^[41],
 Electra Cherry^[41] ^[46]
 cornice / pelmet **N**

- 75/596-B
- 87/596-B
- 110/596-K (-S)
- 140/296-SM
- 140/446-B
- 140/446-SM
- 140/596-B
- 140/596-SM
- 140/896-SM
- 250/446-SM
- 284/296-SM
- 284/446-SM
- 284/596-SM
- 284/896-SM
- 316/596-O
- 355/446-O
- 355/496-O
- 355/596-O
- 355/896-O
- 393/446-O
- 393/596-O
- 500/596-B
- 500/596-O
- 570/296
- 570/296-SM
- 570/446
- 570/446-M
- 570/446-SM
- 570/596
- 570/596-M
- 570/596-SM
- 643/596
- 713/146-CX
- 713/278-N¹⁾
- 713/296
- 713/296-C
- 713/296-CC
- 713/296-Z²⁾
- 713/319-N¹⁾
- 713/396
- 713/446
- 713/446-M
- 713/456
- 713/596
- 713/596-M
- 943/278-N¹⁾
- 943/296
- 943/396
- 943/446
- 943/596
- 1081/446
- 1081/596
- 1247/296-CC
- 1247/446
- 1247/596
- 1261/446
- 1261/596

aluminium frames

aluminium frames p. 19 <<<



aluminium frames

cornice / pelmet

cornice and pelmet dimensions are listed on page 76 >>>

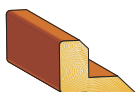

cornice / pelmet **N**
 colours Beech, Windsor Oak, San Alder, Electra Cherry
 material MDF, PVC foil
 available length 2700 mm

1) set of doors for corner units (internal)
 2) set of doors for corner units (external)



51st Vanilla Street

56th Cherry Street

door type **EKRAN**
 door colour Light Vanilla^[51], Korean Cherry^[56]
 material **MDF, PVC foil**
 thickness **19 mm**
 glazing **Master, Frosted** factory fitted
 carcasses **Beech^[51], Windsor Oak^[51], San Alder^[51],
 Electra Cherry^[51] ^[56]
 cornice / pelmet **N****

TRAFFIC 5

same door pattern is available in
BRW Line group
 (EKRAN 135)
 p. 44

available door types

- 75/596-Bpattern u2
- 87/596-Bpattern u2
- 110/596-K (-S)pattern u2
- 140/296-SMpattern u2
- 140/446-Bpattern u2
- 140/446-SMpattern u2
- 140/596-Bpattern u2
- 140/596-SMpattern u2
- 140/896-SMpattern u2
- 250/446-SM
- 250/446-SMV
- 284/296-SM
- 284/446-SM
- 284/596-SM
- 284/896-SM
- 284/896-SMV
- 316/596-O
- 355/446-O
- 355/446-VO
- 355/496-O
- 355/596-O
- 355/596-VO
- 355/896-O
- 355/896-VO
- 393/446-O
- 393/596-O
- 500/596-B
- 500/596-O
- 570/296
- 570/296-SM
- 570/446
- 570/446-M
- 570/446-SM
- 570/596
- 570/596-M
- 570/596-SM
- 643/596
- 713/146-CXpattern u1
- 713/277-N¹⁾
- 713/296
- 713/296-C
- 713/296-CC
- 713/296-Z²⁾
- 713/318-N¹⁾
- 713/396
- 713/396-V
- 713/430-V
- 713/446
- 713/446-M
- 713/446-V
- 713/456
- 713/596
- 713/596-M
- 713/596-V

simplified door types



pattern u1
 rounded
 edge door



pattern u2
 rounded
 edge door
 with routing

glazing / aluminium frames



Master (MA)

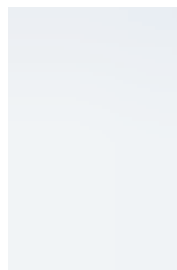

Frosted (ML)

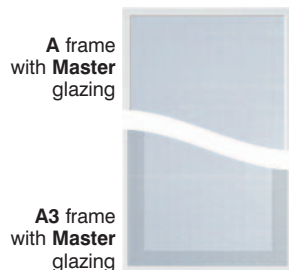

A frame
 with **Master**
 glazing

A3 frame
 with **Master**
 glazing

aluminium frames

aluminium frames p. 19 <<<



A frame
 with **Frosted**
 glazing

A3 frame
 with **Frosted**
 glazing

- 943/277-N¹⁾
- 943/296
- 943/396
- 943/396-V
- 943/430-V
- 943/446
- 943/446-V
- 943/596
- 943/596-V

- 1055/446-V
- 1055/596-V
- 1081/446
- 1081/596

- 1247/296-CC
- 1247/446
- 1247/596

- 1261/446
- 1261/446-V
- 1261/596

cornice / pelmet

cornice and pelmet dimensions are listed on page 76 >>>

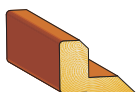

cornice / pelmet **N**
 colours **Beech, Windsor Oak, San Alder, Electra Cherry**
 material **MDF, PVC foil**
 available length **2700 mm**

1) set of doors for corner units (internal)
 2) set of doors for corner units (external)

TRAFFIC 5

available door types



61st Pudding Street

door type SOFT
 door colour Cream
 material chipboard, laminate
 thickness 18 mm
 glazing Frosted with a Rectangle Pattern factory fitted
 carcasses Beech, San Alder
 cornice / pelmet **N**

75/596-B
 87/596-B
 110/596-K (-S)
 140/296-SM
 140/446-B
 140/446-SM
 140/596-B
 140/596-SM
 140/896-SM
 250/446-SM
 250/446-SMV
 284/296-SM
 284/446-SM
 284/596-SM
 284/896-SM
 284/896-SMV

316/596-O
 355/446-O
 355/446-VO
 355/496-O
 355/596-O
 355/596-VO
 355/896-O
 355/896-VO
 393/446-O
 393/596-O

500/596-B
 500/596-O
 570/296
 570/296-SM
 570/446
 570/446-M
 570/446-SM
 570/596
 570/596-M
 570/596-SM

643/596

713/146-CX
 713/278-N¹⁾
 713/296
 713/296-C
 713/296-CC
 713/296-Z²⁾
 713/319-N¹⁾
 713/396
 713/396-V
 713/430-V
 713/446
 713/446-M
 713/446-V
 713/456
 713/596
 713/596-M
 713/596-V

943/278-N¹⁾
 943/296
 943/396
 943/396-V
 943/430-V
 943/446
 943/446-V
 943/596
 943/596-V

1055/446-V
 1055/596-V
 1081/446
 1081/596

1247/296-CC
 1247/446
 1247/596

1261/446
 1261/446-V
 1261/596

1) set of doors for corner units (internal)
 2) set of doors for corner units (external)

glazing

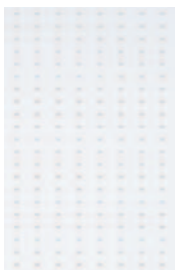

Frosted with a Rectangle Pattern (MP)

cornice / pelmet

cornice and pelmet dimensions are listed on page 76 >>>

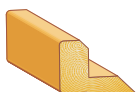

cornice / pelmet **N**
 colours Beech, San Alder
 material MDF, PVC foil
 available length 2700 mm

TRAFFIC

5

available door types



71st Street

72nd Street

door type **FORMA**
 door colour **Dark Vanilla^[71], Green Pea^[72]**
Beech^[74], Honey Alder^[75], Korean Cherry^[76]
 material **MDF, PVC foil**
 thickness **19 mm**
 glazing **Master, Frosted,**
Frosted with a Rectangle Pattern installed on site
 carcasses **Beech^[71] ^[72] ^[74], Windsor Oak^[71] ^[72], San Alder^[71] ^[72] ^[75],**
Electra Cherry^[71] ^[72] ^[76]
 cornice / pelmet **N**



74th Street

75th Street

76th Street

selection of characteristic door types

284/896-SMV / 284/896-VO in colour Antique Nut



- 75/596-B
- 87/596-B
- 110/596-K (-S)
- 140/296-SM
- 140/446-B
- 140/446-SM
- 140/596-B
- 140/596-SM
- 140/896-SM
- 250/446-SM
- 250/446-SMV
- 284/296-SM
- 284/446-SM
- 284/596-SM
- 284/896-SM
- 284/896-SMV
- 284/896-VO
- 316/596-O
- 355/446-O
- 355/446-VO
- 355/496-O
- 355/596-O
- 355/596-VO
- 355/896-O
- 355/896-VO
- 393/446-O
- 393/596-O
- 426/446
- 500/596-B
- 500/596-O
- 570/296
- 570/296-SM
- 570/446
- 570/446-M
- 570/446-SM
- 570/596
- 570/596-M
- 570/596-SM
- 643/596
- 713/146-CX
- 713/277-N¹⁾
- 713/296
- 713/296-C
- 713/296-CC
- 713/296-Z²⁾
- 713/318-N¹⁾
- 713/396
- 713/396-V
- 713/430-V
- 713/446
- 713/446-M
- 713/446-V
- 713/456
- 713/596
- 713/596-M
- 713/596-V

glazing / aluminium frames measurements and indexes of glazing p. 49; aluminium frames p. 19 < >



Master (MA)

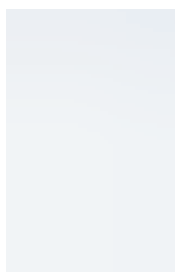

Frosted (ML)

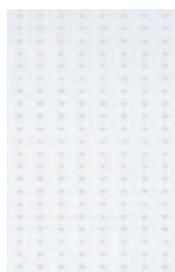

Frosted with a Rectangle Pattern (MP)

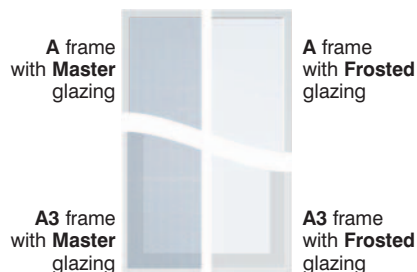

aluminium frames

cornice / pelmet

cornice and pelmet dimensions are listed on page 76 > > >

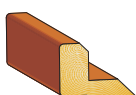

cornice / pelmet **N**
 colours **Beech, Windsor Oak, San Alder, Electra Cherry**
 material **MDF, PVC foil**
 available length **2700 mm**

- 943/277-N¹⁾
- 943/296
- 943/396
- 943/396-V
- 943/430-V
- 943/446
- 943/446-V
- 943/596
- 943/596-V
- 1055/446-V
- 1055/596-V
- 1081/446
- 1081/596
- 1247/296-CC
- 1247/446
- 1247/596
- 1261/446
- 1261/446-V
- 1261/596

- 1) set of doors for corner units (internal)
- 2) set of doors for corner units (external)

FORMA type doors available in colour Antique Nut

- 284/896-SMV
- 284/896-VO

complete TRAFFIC cabinets

up to height of **230 cm** + cornice

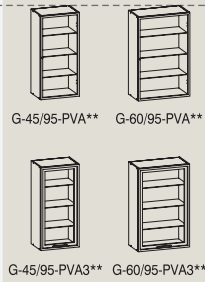
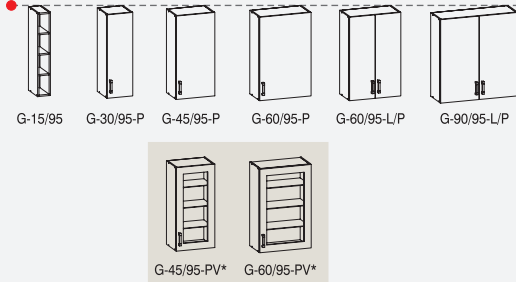

dish drainers

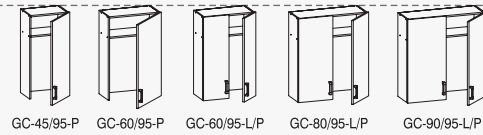

corner units

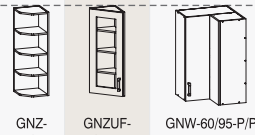

up to height of **207 cm** + cornice

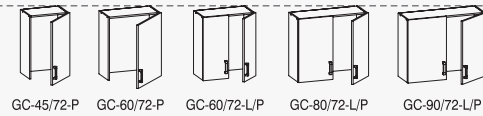
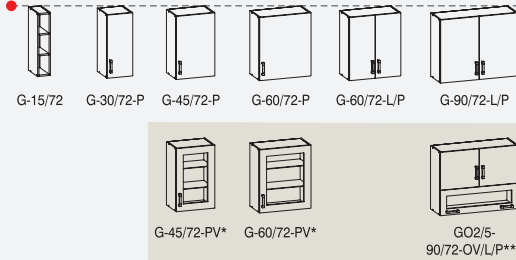

dish drainers

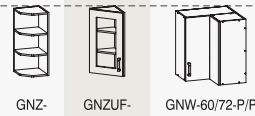

up to height of **82 cm** + worktop

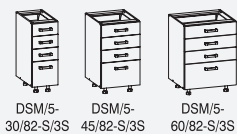
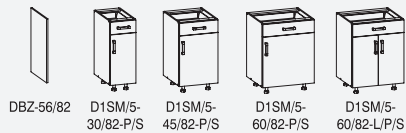
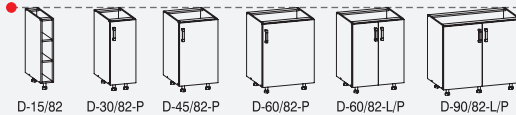

sink units

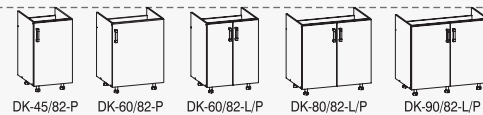

sink units



TRAFFIC

41st Milk Street
46th Sesame Street

51st Vanilla Street
56th Cherry Street

for housing domestic appliances

GNWU-60/95-P
GNWU-60/95-PV*

GNWU-60/72-P
GNWU-60/72-PV*

G2O-60/72-2O
G2O-90/72-2O
G2O-60/72-2OVA**
G2O-90/72-2OVA**
G2O-60/72-2OV*
G2O-90/72-2OV*
G2O-60/72-2OVA3**
G2O-90/72-2OVA3**

GO-45/36-O
GO-50/36-O
GO-60/36-O
GO-90/36-O
GO-45/36-OVA**
GO-60/36-OVA**
GO-90/36-OVA**
GO-45/36-OV*
GO-60/36-OV*
GO-90/36-OV*
GO-45/36-OVA3**
GO-60/36-OVA3**
GO-90/36-OVA3**

TNZ-30/121
TSM/5-45/121-S/PV*
TSM/5-60/121-S/PV*
D-45/207-P/P
DC-30/207-C/C
DL-60/207-P/P
DP-60/207-P/P
DPP450-60/207-P/O

D-45/121-PVA**
T-60/121-PVA**
T-45/121-PVA3**
T-60/121-PVA3**

up to height of **136 cm** + worktop

corner units
DNWU-90/82-P
DNW-105/82-P
DNWP-105/136-P/B
DBNW60-5/82

D-45/136-P
D-45/136-PVA**
D-45/136-PV*
D-45/136-PVA3**
DSM/5-45/136-5S
DSM/5-45/136-5SV*

DCX-15/82-C
DC-30/82-C
DP-60/82-K
DPSX-60/82-S

DM-60/71
DM-45/71
DM-60/57
DM-45/57

for housing domestic appliances

61st Pudding Street

71st Street
72nd Street
74th Street
75th Street
76th Street

* available in: 51st Vanilla Street, 56th Cherry Street, 61st Pudding Street, 71st Street, 72nd Street, 74th Street, 75th Street, 76th Street
 ** available in: 41st Milk Street, 46th Sesame Street, 51st Vanilla Street, 56th Cherry Street, 71st Street, 72nd Street, 74th Street, 75th Street, 76th Street
 *** available in: 71st Street, 72nd Street, 74th Street, 75th Street, 76th Street
 1) in kitchens 71st Street, 72nd Street, 74th Street, 75th Street, 76th Street door with window also in Antique Nut colour

Classic 5

available door types



Rosa

door colour **Antique Cherry Patina**
 material **MDF, PVC foil, lacquer**
 thickness **16 mm**
 glazing **Clear, Rough, Frosted with an Ellipse installed on site**
 carcasses **Elba Cherry, Electra Cherry**
 cornice and pelmet **A**

- 110/596-Kpattern u1
- 140/146-Spattern u1
- 140/146-SMpattern u1
- 140/296-SMpattern u2
- 140/296-STpattern u2
- 140/446-Bpattern u2
- 140/446-SMpattern u2
- 140/446-STpattern u2
- 140/596-Bpattern u2
- 140/596-SMpattern u2
- 140/596-STpattern u2
- 140/896-Bpattern u2
- 140/896-E
- 140/896-SMpattern u2
- 140/896-STpattern u2

- 284/146-SMpattern u1
- 284/296-SMpattern u3
- 284/296-STpattern u3
- 284/446-SMpattern u3
- 284/446-STpattern u3
- 284/596-SMpattern u3
- 284/596-STpattern u3
- 284/896-SMpattern u3
- 284/896-STpattern u3

simplified door types

selection of characteristic door types



pattern u1
rounded edge door



pattern u2
door with reduced frame and simplified routing profile



pattern u3
door with simplified routing profile



- 355/446-O
- 355/446-VO
- 355/496-O
- 355/596-O
- 355/596-VO
- 393/596-O

- 500/596-O
- 570/296-L (-P)
- 570/296-SM
- 570/296-ST
- 570/446-L (-P)
- 570/446-M
- 570/446-SM
- 570/446-ST
- 570/596-L (-P)
- 570/596-M
- 570/596-SM
- 570/596-ST
- 570/896-SM
- 570/896-ST

glazing

measurements and indexes of glazing p. 49 >>>



Clear (CZ)



Rough (MR)



basic design



plain design

Frosted with an Ellipse (ME)

plain design available doors:

- 250/446-SV
- 284/896-SV
- 284/896-VO

- 620/446-LDE (-LGE)
- 620/446-PDE (-PGE)
- 620/446-LVE
- 620/446-PVE
- 643/596-L (-P)

- 713/50-I
- 713/146-CXpattern u1
- 713/296-LZ²⁾ (-PZ²⁾)
- 713/296-L (-P)
- 713/320-LN¹⁾ (-PN¹⁾)
- 713/396-L (-P)
- 713/396-LV (-PV)
- 713/430-LV (-PV)
- 713/446-L (-P)
- 713/446-LV (-PV)
- 713/446-LSW (-PSW)
- 713/446-M
- 713/456-L (-P)
- 713/596-L (-P)
- 713/596-LV (-PV)
- 713/596-M

- 943/50-I
- 943/296-L (-P)
- 943/296-LE
- 943/296-PE
- 943/396-L (-P)
- 943/396-LV (-PV)
- 943/430-LV (-PV)
- 943/446-L (-P)
- 943/446-LV (-PV)
- 943/596-L (-P)
- 943/596-LV (-PV)

1081/596-L (-P)

- 1247/446-L (-P)
- 1247/446-LSW (-PSW)
- 1247/596-L (-P)

1) set of doors for corner units (internal)
 2) set of doors for corner units (external)

cornice and pelmet

cornice and pelmet dimensions are listed on page 76 >>>

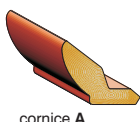

cornice A



pelmet A

cornice and pelmet **A**
 colour **Korean Cherry Patina**
 material **MDF, PVC foil, lacquer**
 available length **2700 mm**

Classic 5

available door types



Ledo

door colour Italian Cherry Patina
 material MDF, PVC foil, lacquer
 thickness 16 mm
 glazing Clear, Rough, Frosted with an Ellipse installed on site
 carcass Elba Cherry
 cornice **A**

- 110/596-Kpattern u1
- 140/146-Spattern u1
- 140/146-SMpattern u1
- 140/296-SMpattern u2
- 140/296-STpattern u2
- 140/446-Bpattern u2
- 140/446-SMpattern u2
- 140/446-STpattern u2
- 140/596-Bpattern u2
- 140/596-SMpattern u2
- 140/596-STpattern u2
- 140/896-Bpattern u2
- 140/896-E
- 140/896-SMpattern u2
- 140/896-STpattern u2

- 284/146-SMpattern u1
- 284/296-SMpattern u3
- 284/296-STpattern u3
- 284/446-SMpattern u3
- 284/446-STpattern u3
- 284/596-SMpattern u3
- 284/596-STpattern u3
- 284/896-SMpattern u3
- 284/896-STpattern u3

- 355/446-O
- 355/446-VO
- 355/496-O
- 355/596-O
- 355/596-VO
- 393/596-O

- 500/596-O
- 570/296
- 570/296-SM
- 570/296-ST
- 570/446
- 570/446-M
- 570/446-SM
- 570/446-ST
- 570/596
- 570/596-M
- 570/596-SM
- 570/596-ST
- 570/896-SM
- 570/896-ST

- 620/446-LDE (-LGE)
- 620/446-PDE (-PGE)
- 620/446-LVE
- 620/446-PVE
- 643/596

- 713/50-I
- 713/146-CXpattern u1
- 713/296
- 713/296-Z²⁾
- 713/320-N¹⁾

- 713/396
- 713/396-V
- 713/430-V
- 713/446
- 713/446-V
- 713/446-LSW (-PSW)
- 713/446-M
- 713/456
- 713/596
- 713/596-V
- 713/596-M

- 943/50-I
- 943/296
- 943/296-LE
- 943/296-PE
- 943/396
- 943/396-V
- 943/430-V
- 943/446
- 943/446-V
- 943/596
- 943/596-V

1081/596

- 1247/446
- 1247/446-LSW (-PSW)
- 1247/596

1) set of doors for corner units (internal)
 2) set of doors for corner units (external)

simplified door types

selection of characteristic door types



pattern u1
rounded edge door



pattern u2
door with reduced width reduced frame and simplified routing profile



pattern u3
door with simplified routing profile

140/896-E



620/446-LE

620/446-PVE + glass CZ

713/50-I (pilaster)

943/296-PE



glazing

measurements and indexes of glazing p. 49 >>>



Clear (CZ)



Rough (MR)



basic design



plain design

Frosted with an Ellipse (ME)

plain design available doors:

- 250/446-SV
- 284/896-SV
- 284/896-VO

cornice

cornice dimensions are listed on page 76 >>>

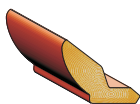

cornice A

cornice **A**
 colour Italian Cherry Patina
 material MDF, PVC foil, lacquer
 available length 2440 mm



Dekorado

Classic 5

door colour **Calvados Patina**
 material **MDF, PVC foil, lacquer**
 thickness **20 mm**
 glazing **Rough, Clear with Strip** factory fitted
 carcass **Electra Cherry**
 cornice **A**

available door types

- 110/596-Kpattern u1
- 140/146-Spattern u1
- 140/146-SMpattern u1
- 140/296-SMpattern u2
- 140/296-STpattern u2
- 140/446-Bpattern u2
- 140/446-SMpattern u2
- 140/446-STpattern u2
- 140/596-Bpattern u2
- 140/596-SMpattern u2
- 140/596-STpattern u2
- 140/896-Bpattern u2
- 140/896-SMpattern u2
- 140/896-STpattern u2

- 284/146-SM
- 284/296-SM
- 284/296-ST
- 284/446-SM
- 284/446-ST
- 284/596-SM
- 284/596-ST
- 284/896-SM
- 284/896-ST

- 355/446-O
- 355/446-VO
- 355/496-O
- 355/596-O
- 355/596-VO
- 393/596-O

- 500/596-O
- 570/296
- 570/296-SM
- 570/296-ST
- 570/446
- 570/446-M
- 570/446-SM
- 570/446-ST
- 570/596
- 570/596-M
- 570/596-SM
- 570/596-ST
- 570/896-SM
- 570/896-ST

643/596

- 713/50-I
- 713/146-CXpattern u1
- 713/296-Z²⁾
- 713/296
- 713/325-N¹⁾
- 713/396
- 713/396-V (-LV, -PV)
- 713/430-V (-LV, -PV)
- 713/446
- 713/446-V (-LV, -PV)
- 713/446-LSW (-PSW)
- 713/446-M
- 713/456
- 713/596
- 713/596-V (-LV, -PV)
- 713/596-M

- 943/50-I
- 943/296
- 943/396
- 943/396-V (-LV, -PV)
- 943/430-V (-LV, -PV)
- 943/446
- 943/446-V (-LV, -PV)
- 943/596
- 943/596-V (-LV, -PV)

1081/596

- 1247/446
- 1247/446-LSW (-PSW)
- 1247/596

1) set of doors for corner units (internal)
 2) set of doors for corner units (external)

simplified door types

selection of characteristic door types



pattern u1
door without panelling

pattern u2
flat panel door



713/50-I (pilaster)

glazing

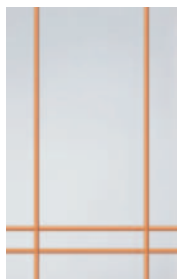

Clear with Strip (CL)



Rough (MR)

cornice

cornice dimensions are listed on page 76 >>>

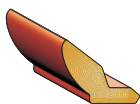

cornice A

cornice **A**
 colour **Calvados Patina**
 material **MDF, PVC foil, lacquer**
 available length **2440 mm**



Melos

door colour Orange Birch
 material solid wood (birch)
 thickness 25 mm
 glazing Cristal factory fitted
 carcass Elba Cherry
 cornice and pelmet **W**

Classic 5

also available in colours of the door



hoods p. 114-117

available door types

- 110/596-Kpattern u1
- 140/146-Spattern u1
- 140/146-SMpattern u1
- 140/296-SMpattern u1
- 140/296-STpattern u1
- 140/446-Bpattern u1
- 140/446-SMpattern u1
- 140/446-STpattern u1
- 140/596-Bpattern u1
- 140/596-SMpattern u1
- 140/596-STpattern u1
- 140/896-Bpattern u1
- 140/896-E
- 140/896-SMpattern u1
- 140/896-STpattern u1
- 284/146-SMpattern u1
- 284/296-SM
- 284/296-ST
- 284/446-SM
- 284/446-ST
- 284/596-SM
- 284/596-ST
- 284/896-SM
- 284/896-ST
- 355/446-O
- 355/446-VO
- 355/496-O
- 355/596-O
- 355/596-VO
- 393/596-O
- 500/596-O
- 570/296-L (-P)
- 570/296-SM
- 570/296-ST
- 570/446-L (-P)
- 570/446-M
- 570/446-SM
- 570/446-ST
- 570/596-L (-P)
- 570/596-M
- 570/596-SM
- 570/596-ST
- 570/896-SM
- 570/896-ST
- 620/446-LDE (-LGE)
- 620/446-PDE (-PGE)
- 620/446-LVE
- 620/446-PVE
- 643/596-L (-P)
- 713/146-CXpattern u1
- 713/296-L (-P)
- 713/296-LZ²⁾ (-PZ²⁾)
- 713/312-LN¹⁾ (-PN¹⁾)
- 713/396-L (-P)
- 713/396-LV (-PV)
- 713/430-LV (-PV)
- 713/446-L (-P)
- 713/446-LV (-PV)
- 713/446-LSW (-PSW)
- 713/446-M
- 713/456-L (-P)
- 713/596-L (-P)
- 713/596-LV (-PV)
- 713/596-M
- 943/296-L (-P)
- 943/296-LE
- 943/296-PE
- 943/396-L (-P)
- 943/396-LV (-PV)
- 943/430-LV (-PV)
- 943/446-L (-P)
- 943/446-LV (-PV)
- 943/596-L (-P)
- 943/596-LV (-PV)
- 1081/596-L (-P)
- 1247/446-L (-P)
- 1247/446-LSW (-PSW)
- 1247/596-L (-P)

simplified door types



pattern u1
 solid door
 straight

selection of characteristic door types



140/896-E

943/296-PE

620/446-LDE (-LGE)

620/446-PVE

doors: 713/312-LN¹⁾ (-PN¹⁾) for cabinet DNW-90/82
 have one edge chamfered



door left of set
 713/312-LN¹⁾

glazing



Cristal

cornice and pelmet

cornice and pelmet dimensions are listed on page 76 >>>

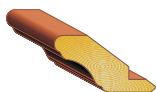

cornice **W**
 colour Morello Cherry
 material MDF, veneer
 available length 2700 mm



pelmet **W**
 colour Morello Cherry
 material MDF, veneer
 available length 2700 mm

1) set of doors for corner units (internal)
 2) set of doors for corner units (external)

Modern Line group cabinet doors

Modern 5

available door types



Diona
Wenge

Diona
Milan Oak

Diona
Golden Cherry

material chipboard, PVC foil, lacquer
 thickness 18 mm
 glazing Master, Frosted only in aluminium frames
 carcasses Milan Oak, Wenge, Elba Cherry, Electra Cherry
 cornice/pelmet **N**



Diona door colours - horizontal grain pattern

- 110/596-K
- 140/146-SM
- 140/296-SM
- 140/296-ST
- 140/446-B
- 140/446-SM
- 140/446-ST
- 140/596-B
- 140/596-SM
- 140/596-ST
- 140/896-B
- 140/896-SM
- 140/896-ST

- 284/146-SM
- 284/296-SM
- 284/296-ST
- 284/446-SM
- 284/446-ST
- 284/596-SM
- 284/596-ST
- 284/896-SM
- 284/896-ST

- 316/596
- 355/446-O
- 355/496-O
- 355/596-O
- 355/896-O
- 393/596-O

- 500/596-O
- 570/296
- 570/296-SM
- 570/296-ST
- 570/446
- 570/446-M
- 570/446-SM
- 570/446-ST
- 570/596
- 570/596-M
- 570/596-SM
- 570/596-ST
- 570/896-SM
- 570/896-ST

- 643/596

- 713/146-CX
- 713/296
- 713/296-Z²⁾
- 713/318-N¹⁾
- 713/396
- 713/446
- 713/446-LSW (-PSW)
- 713/446-M
- 713/456
- 713/596
- 713/596-M

- 943/296
- 943/396
- 943/446
- 943/596

- 1081/596

- 1247/446
- 1247/446-LSW (-PSW)
- 1247/596

1) set of doors for corner units (internal)
 2) set of doors for corner units (external)

aluminium frames

aluminium frames page 19 <<<



aluminium frames

cornice / pelmet

cornice and pelmet dimensions are listed on page 76 >>>

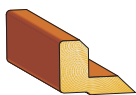

cornice / pelmet **N**
 colours Milan Oak, Wenge, Elba Cherry, Electra Cherry
 material MDF, PVC foil
 available length 2700 mm

Modern 5

available door types



Hedar
Golden Cherry

material chipboard, PVC foil, lacquer
 thickness 18 mm
 glazing Master, Frosted only in aluminium frames
 carcasses Milan Oak, Wenge, Elba Cherry, Electra Cherry
 cornice/pelmet **N**

110/596-K
 140/146-SM
 140/296-SM
 140/296-ST
 140/446-B
 140/446-SM
 140/446-ST
 140/596-B
 140/596-SM
 140/596-ST
 140/896-B
 140/896-SM
 140/896-ST

284/146-SM
 284/296-SM
 284/296-ST
 284/446-SM
 284/446-ST
 284/596-SM
 284/596-ST
 284/896-SM
 284/896-ST

316/596
 355/446-O
 355/446-OD
 355/496-O
 355/596-O
 355/596-OD
 355/896-O
 355/896-OD
 393/596-O

500/596-O
 570/296
 570/296-SM
 570/296-ST
 570/446
 570/446-M
 570/446-SM
 570/446-ST
 570/596
 570/596-M
 570/596-SM
 570/596-ST
 570/896-SM
 570/896-ST

643/596-L (-P)

713/146-CX
 713/296
 713/296-Z²⁾
 713/318-N¹⁾
 713/396
 713/446
 713/446-LSW (-PSW)
 713/446-M
 713/456
 713/596
 713/596-M

943/296-L (-P)
 943/396-L (-P)
 943/446-L (-P)
 943/596-L (-P)

1081/596-L (-P)

1247/446-L (-P)
 1247/446-LSW (-PSW)
 1247/596-L (-P)

1) set of doors for corner units (internal)
 2) set of doors for corner units (external)



Hedar door colours - horizontal grain pattern

Notice: Routing pattern in Hedar doors are made for '5' system and corresponding to drawers height of 140mm. Here we differentiate symmetrical doors (reversible) and non-symmetrical

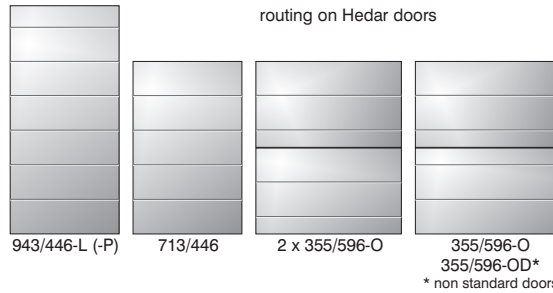

Hedar routed doors non-symmetrical
 316/596-O, 355/446-O, 355/496-O, 355/596-O, 355/896-O
 393/596-O, 500/596-O,
 643/596-L (-P),
 943/296-L (-P), 943/396-L (-P), 943/446-L (-P), 943/596-L (-P),
 1081/596-L (-P),
 1247/446-L (-P), 1247/446-LSW (-PSW), 1247/596-L (-P).

On request hood doors made with a reversed routing. They are doors for the lower hood cabinet, in a set of two cabinets GO type, one above the other

Available measurements of lower hood doors (with reversed routing) 355/446-OD, 355/596-OD, 355/896-OD.

aluminium frames

aluminium frames page 19 <<



aluminium frames

cornice / pelmet

cornice and pelmet dimensions are listed on page 76 >>>

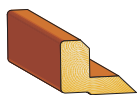

cornice / pelmet **N**
 colours Milan Oak, Wenge, Elba Cherry, Electra Cherry
 material MDF, PVC foil
 available length 2700 mm

Modern 5

available door types



Telesto
Wenge

Telesto
Milan Oak

Telesto
Golden Cherry

Telesto
Nida Maple

material MDF, PVC foil, lacquer
 thickness 19 mm
 glazing Frosted factory fitted
 carcasses Milan Oak, Maple Nida, Wenge,
 Elba Cherry, Electra Cherry
 cornice/pelmet **N**



Telesto doors in colours Milan Oak and Wenge - **natural grain horizontal panel**



Telesto doors in colours Golden Cherry and Nida Maple - **natural grain vertical panel**

simplified door types



pattern u1
simple door
without routing

glazing / aluminium frames

aluminium frames p. 19 <<<

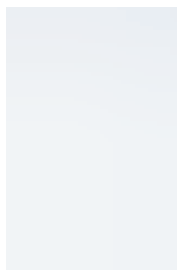

Frosted (ML)



aluminium frames

A frame
with **Frosted**
glazing

A3 frame
with **Frosted**
glazing

cornice / pelmet

cornice and pelmet dimensions are listed on page 76 >>>

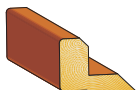

cornice / pelmet **N**
 colours Milan Oak, Maple Nida, Wenge, Elba Cherry, Electra Cherry
 material MDF, PVC foil
 available length 2700 mm

- 110/596-K.....pattern u1
- 140/146-SM.....pattern u1
- 140/296-SM.....pattern u1
- 140/296-ST.....pattern u1
- 140/446-B.....pattern u1
- 140/446-SM.....pattern u1
- 140/446-ST.....pattern u1
- 140/596-B.....pattern u1
- 140/596-SM.....pattern u1
- 140/596-ST.....pattern u1
- 140/896-B.....pattern u1
- 140/896-SM.....pattern u1
- 140/896-ST.....pattern u1

- 284/146-SM
- 284/296-SM
- 284/296-ST
- 284/446-SM
- 284/446-ST
- 284/596-SM
- 284/596-ST
- 284/896-SM
- 284/896-ST

- 316/596
- 355/446-O
- 355/446-VO
- 355/496-O
- 355/596-O
- 355/596-VO
- 355/896-O
- 355/896-VO
- 393/596-O

- 500/596-O
- 570/296
- 570/296-SM
- 570/296-ST
- 570/446
- 570/446-M
- 570/446-SM
- 570/446-ST
- 570/596
- 570/596-M
- 570/596-SM
- 570/596-ST
- 570/896-SM
- 570/896-ST

643/596

- 713/146-CX.....pattern u1
- 713/296
- 713/296-Z²⁾
- 713/317-N¹⁾
- 713/396
- 713/396-V
- 713/430-V
- 713/446
- 713/446-V
- 713/446-LSW (-PSW)
- 713/446-M
- 713/456
- 713/596
- 713/596-V
- 713/596-M

- 943/296
- 943/396
- 943/396-V
- 943/430-V
- 943/446
- 943/446-V
- 943/596
- 943/596-V

1081/596

- 1247/446
- 1247/446-LSW (-PSW)
- 1247/596

1) set of doors for corner units (internal)
 2) set of doors for corner units (external)



KARTA

door type **KARTA (KAR)**
 door colour according to BRW laminate pattern; p. 4-5
 material **MDF, PVC foil**
 thickness **16 mm**
 glazing **Clear, Rough, Frosted with an Ellipse** installed on site
 carcasses **Beige, White, Beech, Milan Oak, Windsor Oak, Maple Nida, Grey, San Alder, Wenge, Elba Cherry, Electra Cherry, Portofino Cherry**
 cornice **A**



available cabinet shapes for classic doors according to arrangement for group



available door types

- 110/596-K.....pattern u2
- 140/146-S.....pattern u1
- 140/146-SM.....pattern u1
- 140/296-SM.....pattern u2
- 140/296-ST.....pattern u2
- 140/446-B.....pattern u2
- 140/446-SM.....pattern u2
- 140/446-ST.....pattern u2
- 140/596-B.....pattern u2
- 140/596-SM.....pattern u2
- 140/596-ST.....pattern u2
- 140/896-B.....pattern u2
- 140/896-E
- 140/896-SM.....pattern u2
- 140/896-ST.....pattern u2

- 284/146-SM.....pattern u1
- 284/296-SM.....pattern u3
- 284/296-ST.....pattern u3
- 284/446-SM.....pattern u3
- 284/446-ST.....pattern u3
- 284/596-SM.....pattern u3
- 284/596-ST.....pattern u3
- 284/896-SM.....pattern u3
- 284/896-ST.....pattern u3



NOTE: Normally, all standard doors have a **vertical grain** pattern, however it is possible to order a **horizontal grain** doors if requested. In door colour index letter H next to the colour number stands for horizontal wood graining (K04-BL_KAR-112H-140/446...).

simplified door types



pattern u1 rounded edge door



pattern u2 door with reduced frame and routing profile



pattern u3 door with reduced routing profile

selection of characteristic door types



glazing

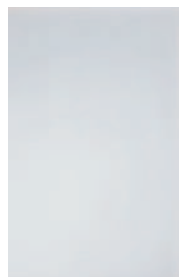

Clear (CZ)



Rough (MR)



basic design



plain design

glass sizes and indices, see page 49 >>>

Frosted with an Ellipse (ME)

plain design available doors:
 250/446-SV
 284/896-SV
 284/896-VO

cornice

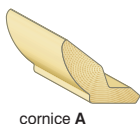

cornice A

cornice **A**
 colours according to pattern BRW laminate*
 material **MDF, PVC foil**
 available length **2440 mm**



cornice A

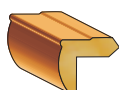

pelmet A

for available cornices and pelmets, see page 76 >>>

cornice and pelmet **A**
 colours **Beech, Windsor Oak, San Alder, Electra Cherry**
 material **MDF, PVC foil**
 available length **2700 mm**

- 355/446-O
- 355/446-VO
- 355/496-O
- 355/596-O
- 355/596-VO
- 393/596-O

- 500/596-O
- 570/296
- 570/296-SM
- 570/296-ST
- 570/446
- 570/446-M
- 570/446-SM
- 570/446-ST
- 570/596
- 570/596-M
- 570/596-SM
- 570/596-ST
- 570/896-SM
- 570/896-ST

- 620/446-LDE (-PDE)
- 620/446-LGE (-PGE)
- 620/446-LVE
- 620/446-PVE
- 643/596

- 713/50-I
- 713/146-CX.....pattern u1
- 713/296
- 713/296-Z²⁾
- 713/321-N¹⁾
- 713/396
- 713/396-V
- 713/430-V
- 713/446
- 713/446-V
- 713/446-LSW (-PSW)
- 713/446-M
- 713/456
- 713/596
- 713/596-V
- 713/596-M

- 943/50-I
- 943/296
- 943/296-LE
- 943/296-PE
- 943/396
- 943/396-V
- 943/430-V
- 943/446
- 943/446-V
- 943/596
- 943/596-V

1081/596

- 1247/446
- 1247/446-LSW (-PSW)
- 1247/596

- 1) set of doors for corner units (internal)
- 2) set of doors for corner units (external)

* with the exception of gloss laminate - No 152 - 154



FALA

door type **FALA (FAL)**
 door colour according to BRW laminate pattern; p. 4-5
 material **MDF, PVC foil**
 thickness **16 mm**
 glazing **Clear, Rough, Frosted with an Ellipse** installed on site
 carcasses **Beige, White, Beech, Milan Oak, Windsor Oak, Maple Nida, San Alder, Wenge, Elba Cherry, Electra Cherry, Portofino Cherry, Grey**
 cornice **A**



available cabinet shapes for classic doors according to arrangement for



available door types

- 110/596-K.....pattern u1
- 140/146-S.....pattern u1
- 140/146-SM.....pattern u1
- 140/296-SM.....pattern u2
- 140/296-ST.....pattern u2
- 140/446-B.....pattern u2
- 140/446-SM.....pattern u2
- 140/446-ST.....pattern u2
- 140/596-B.....pattern u2
- 140/596-SM.....pattern u2
- 140/596-ST.....pattern u2
- 140/896-B.....pattern u2
- 140/896-E
- 140/896-SM.....pattern u2
- 140/896-ST.....pattern u2

- 284/146-SM.....pattern u1
- 284/296-SM
- 284/296-ST
- 284/446-SM
- 284/446-ST
- 284/596-SM
- 284/596-ST
- 284/896-SM
- 284/896-ST



NOTE: Normally, all standard doors have a **vertical grain** pattern, however it is possible to order a **horizontal grain** doors if requested. In door colour index letter H next to the colour number stands for horizontal wood graining (K04-BL_FAL-112H-140/446...).

simplified door types



selection of characteristic door types



- 355/446-O
- 355/446-VO
- 355/496-O
- 355/596-O
- 355/596-VO
- 393/596-O

- 500/596-O
- 570/296-L (-P)
- 570/296-SM
- 570/296-ST
- 570/446-L (-P)
- 570/446-M
- 570/446-SM
- 570/446-ST
- 570/596-L (-P)
- 570/596-M
- 570/596-SM
- 570/596-ST
- 570/896-SM
- 570/896-ST

- 615/446-LDE (-PDE)
- 615/446-LGE (PGE)
- 615/446-LVE
- 615/446-PVE
- 643/596-L (-P)

- 713/50-I
- 713/146-CX.....pattern u1
- 713/296-L (-P)
- 713/296-LZ²⁾ (-PZ²⁾)
- 713/321-LN¹⁾ (-PN¹⁾)
- 713/396-L (-P)
- 713/396-LV (-PV)
- 713/430-LV (-PV)
- 713/446-L (-P)
- 713/446-LV (-PV)
- 713/446-LSW (-PSW)
- 713/446-M
- 713/456-L (-P)
- 713/596-L (-P)
- 713/596-LV (-PV)
- 713/596-M

glazing

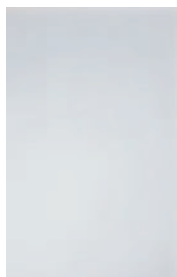

Clear (CZ)



Rough (MR)



basic design



plain design

glass sizes and indices, see page 49 >>>

Frosted with an Ellipse (ME)

plain design available doors:
 250/446-SV
 284/896-SV
 284/896-VO

cornice

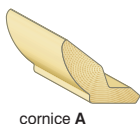

cornice **A**
 colours according to pattern BRW laminate*
 material **MDF, PVC foil**
 available length **2440 mm**



cornice A



pelmet A

for available cornices and pelmets, see page 76 >>>

cornice and pelmet **A**
 colours **Beech, Windsor Oak, San Alder, Electra Cherry**
 material **MDF, PVC foil**
 available length **2700 mm**

- 1081/596-L (-P)
- 1247/446-L (-P)
- 1247/446-LSW (-PSW)
- 1247/596-L (-P)

- 1) set of doors for corner units (internal)
- 2) set of doors for corner units (external)

* with the exception of gloss laminate - No 152 - 154



PORTAL

door type **PORTAL (POR)**
 door colour according to BRW laminate pattern; p. 4-5
 material **MDF, PVC foil**
 thickness **16 mm**
 glazing **Clear, Rough, Frosted with an Ellipse** installed on site
 carcasses **Beige, White, Beech, Milan Oak, Windsor Oak, Maple Nida, San Alder, Wenge, Elba Cherry, Electra Cherry, Portofino Cherry, Grey**
 cornice **A**



available cabinet shapes for classic doors according to arrangement for



available door types

- 110/596-K.....pattern u1
- 140/146-S.....pattern u1
- 140/146-SM.....pattern u1
- 140/296-SM.....pattern u2
- 140/296-ST.....pattern u2
- 140/446-B.....pattern u2
- 140/446-SM.....pattern u2
- 140/446-ST.....pattern u2
- 140/596-B.....pattern u2
- 140/596-SM.....pattern u2
- 140/596-ST.....pattern u2
- 140/896-B.....pattern u2
- 140/896-E
- 140/896-SM.....pattern u2
- 140/896-ST.....pattern u2
- 284/146-SM.....pattern u1
- 284/296-SM
- 284/296-ST
- 284/446-SM
- 284/446-ST
- 284/596-SM
- 284/596-ST
- 284/896-SM
- 284/896-ST



NOTE: Normally, all standard doors have a **vertical grain** pattern, however it is possible to order a **horizontal grain** doors if requested. In door colour index letter H next to the colour number stands for horizontal wood graining (K04-BL_KAR-112H-140/446...).

simplified door types



pattern u1
rounded edge door



pattern u2
door with reduced frame and routing profile

selection of characteristic door types



- 355/446-O
- 355/446-VO
- 355/496-O
- 355/596-O
- 355/596-VO
- 393/596-O

- 500/596-O
- 570/296-L (-P)
- 570/296-SM
- 570/296-ST
- 570/446-L (-P)
- 570/446-M
- 570/446-SM
- 570/446-ST
- 570/596-L (-P)
- 570/596-M
- 570/596-SM
- 570/596-ST
- 570/896-SM
- 570/896-ST

- 620/446-LDE (-PDE)
- 620/446-LGE (-PGE)
- 620/446-LVE
- 620/446-PVE
- 643/596-L (-P)

- 713/50-I
- 713/146-CX.....pattern u1
- 713/296-L (-P)
- 713/296-LZ⁽²⁾ (-PZ⁽²⁾)
- 713/321-LN⁽¹⁾ (-PN⁽¹⁾)
- 713/396-L (-P)
- 713/396-LV (-PV)
- 713/430-LV (-PV)
- 713/446-L (-P)
- 713/446-LV (-PV)
- 713/446-LSW (-PSW)
- 713/446-M
- 713/456-L (-P)
- 713/596-L (-P)
- 713/596-LV (-PV)
- 713/596-M

glazing



Clear (CZ)



Rough (MR)



basic design



plain design

glass sizes and indices, see page 49 >>>

Frosted with an Ellipse (ME)

plain design available doors:

- 250/446-SV
- 284/896-SV
- 284/896-VO

cornice

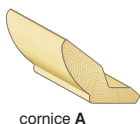

cornice A

cornice **A**
 colours according to pattern BRW laminate*
 material **MDF, PVC foil**
 available length **2440 mm**



cornice A



pelmet A

for available cornices and pelmets, see page 76 >>>

cornice and pelmet **A**
 colours **Beech, Windsor Oak, San Alder, Electra Cherry**
 material **MDF, PVC foil**
 available length **2700 mm**

- 1081/596-L (-P)
- 1247/446-L (-P)
- 1247/446-LSW (-PSW)
- 1247/596-L (-P)

- 1) set of doors for corner units (internal)
- 2) set of doors for corner units (external)

* with the exception of glass laminate - No 152 - 154



EKRAN

door type **EKRAN (EKR)**
 door colour according to BRW laminate pattern; p. 4-5
 material **MDF, PVC foil**
 thickness **19 mm**
 glazing **Master, Frosted** factory fitted
 carcasses **Beige, White, Beech, Milan Oak, Windsor Oak, Maple Nida, San Alder, Wenge, Elba Cherry, Electra Cherry, Portofino Cherry, Grey**
 cornice / pelmet **N**



available cabinet shapes for **modern** doors according to arrangement for group



available door types

- 110/596-K.....pattern u2
- 140/146-SM.....pattern u1
- 140/296-SM.....pattern u2
- 140/296-ST.....pattern u2
- 140/446-B.....pattern u2
- 140/446-SM.....pattern u2
- 140/446-ST.....pattern u2
- 140/596-B.....pattern u2
- 140/596-SM.....pattern u2
- 140/596-ST.....pattern u2
- 140/896-B.....pattern u2
- 140/896-SM.....pattern u2
- 140/896-ST.....pattern u2

- 284/146-SM.....pattern u1
- 284/296-SM
- 284/296-ST
- 284/446-SM
- 284/446-ST
- 284/596-SM
- 284/596-ST
- 284/896-SM
- 284/896-ST

- 316/596
- 355/446-O
- 355/446-VO
- 355/496-O
- 355/596-O
- 355/596-VO
- 355/896-O
- 355/896-VO
- 393/596-O

- 500/596-O
- 570/296
- 570/296-SM
- 570/296-ST
- 570/446
- 570/446-M
- 570/446-SM
- 570/446-ST
- 570/596
- 570/596-M
- 570/596-SM
- 570/596-ST
- 570/896-SM
- 570/896-ST

643/596

- 713/146-CX.....pattern u1
- 713/296
- 713/296-Z²⁾
- 713/318-N¹⁾
- 713/396
- 713/396-V
- 713/430-V
- 713/446
- 713/446-V
- 713/446-LSW (-PSW)
- 713/446-M
- 713/456
- 713/596
- 713/596-V
- 713/596-M

- 943/296
- 943/396
- 943/396-V
- 943/430-V
- 943/446
- 943/446-V
- 943/596
- 943/596-V

1081/596

- 1247/446
- 1247/446-LSW (-PSW)
- 1247/596

1) set of doors for corner units (internal)
 2) set of doors for corner units (external)



NOTE: Normally, all standard doors have a **vertical grain** pattern, however it is possible to order a **horizontal grain** doors if requested. In door colour index letter H next to the colour number stands for horizontal wood graining (K04-BL_KAR-112H-140/446...).

simplified door types



pattern u1
rounded edge door



pattern u2
simple door with routing

glazing / aluminium frames



Master (MA)

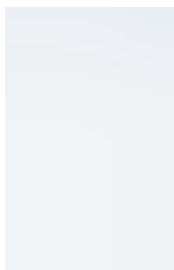

Frosted (ML)

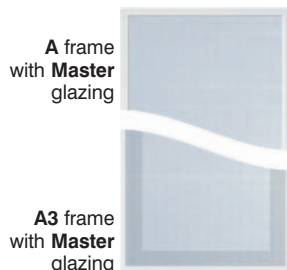

A frame with **Master** glazing

A3 frame with **Master** glazing



A frame with **Frosted** glazing

A3 frame with **Frosted** glazing

aluminium frames

aluminium frames p. 19 <<<

cornice / pelmet

cornice and pelmet dimensions are listed on page 76 >>>

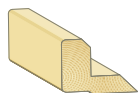

cornice / pelmet **N**
 colours according to pattern BRW laminate*
 material **MDF, PVC foil**
 available length **2440 mm**

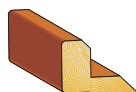

cornice / pelmet **N**
 colours **Beech, Milan Oak, Maple Nida, San Alder, Wenge, Elba Cherry, Electra Cherry**
 material **MDF, PVC foil**
 available length **2700 mm**

* with the exception of gloss laminate - No 152 - 154



TAFLA MDF

door type TAFLA MDF (TAF_MDF)
 door colour according to BRW laminate pattern; p. 4-5
 material MDF, PVC foil
 thickness 19 mm
 glazing Master, Frosted factory fitted
 carcasses Beige, White, Beech, Milan Oak, Windsor Oak, Maple Nida, San Alder, Wenge, Elba Cherry, Electra Cherry, Portofino Cherry, Grey
 cornice / pelmet **N**



available cabinet shapes for **modern** doors according to arrangement for group



available door types

110/596-K
 140/146-SM
 140/296-SM
 140/296-ST
 140/446-B
 140/446-SM
 140/446-ST
 140/596-B
 140/596-SM
 140/596-ST
 140/896-B
 140/896-SM
 140/896-ST

284/146-SM
 284/296-SM
 284/296-ST
 284/446-SM
 284/446-ST
 284/596-SM
 284/596-ST
 284/896-SM
 284/896-ST

316/596
 355/446-O
 355/446-VO
 355/496-O
 355/596-O
 355/596-VO
 355/896-O
 355/896-VO
 393/596-O

500/596-O
 570/296
 570/296-SM
 570/296-ST
 570/446
 570/446-M
 570/446-SM
 570/446-ST
 570/596
 570/596-M
 570/596-SM
 570/596-ST
 570/896-SM
 570/896-ST

643/596

713/146-CX
 713/296
 713/296-Z²⁾
 713/318-N¹⁾
 713/396
 713/396-V
 713/430-V
 713/446
 713/446-V
 713/446-LSW (-PSW)
 713/446-M
 713/456
 713/596
 713/596-V
 713/596-M

943/296
 943/396
 943/396-V
 943/430-V
 943/446
 943/446-V
 943/596
 943/596-V

1081/596

1247/446
 1247/446-LSW (-PSW)
 1247/596

1) set of doors for corner units (internal)
 2) set of doors for corner units (external)



NOTE: Normally, all standard doors have a **vertical grain** pattern, however it is possible to order a **horizontal grain** doors if requested. In door colour index letter H next to the colour number stands for horizontal wood graining (K04-BL_KAR-112H-140/446...).

glazing / aluminium frames



Master (MA)

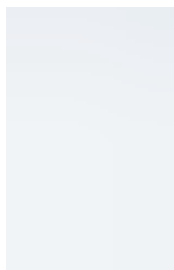

Frosted (ML)

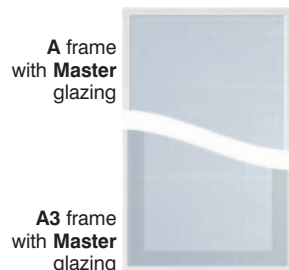

A frame with Master glazing

A3 frame with Master glazing



A frame with Frosted glazing

A3 frame with Frosted glazing

aluminium frames

aluminium frames p. 19 <<<

cornice / pelmet

cornice and pelmet dimensions are listed on page 76 >>>

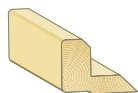

cornice / pelmet **N**
 colours according to pattern BRW laminate*
 material MDF, PVC foil
 available length 2440 mm

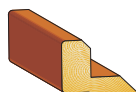

cornice / pelmet **N**
 colours Beech, Milan Oak, Maple Nida, San Alder, Wenge, Elba Cherry, Electra Cherry
 material MDF, PVC foil
 available length 2700 mm

* with the exception of gloss laminate - No 152 - 154

complete Classic Line cabinets

up to height of **230 cm** + cornice

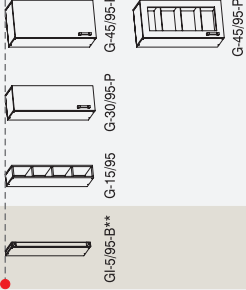

up to height of **207 cm** + cornice

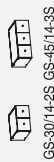
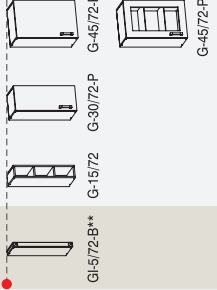

GS-30/14-2S GS-45/14-3S

up to height of **82 cm** + worktop

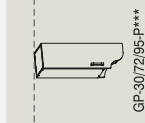
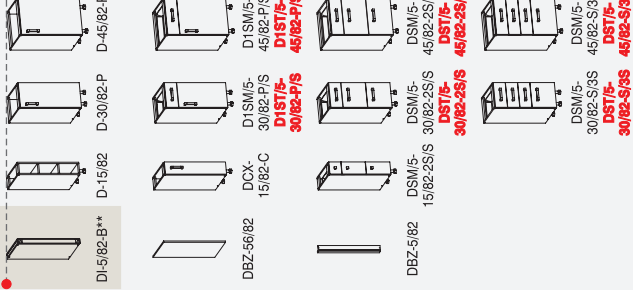

GF-30/72/95-P***

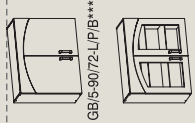

GB/5-90/72-LP/B***
GB/5-90/72-LP/PV/B***

dish drainers

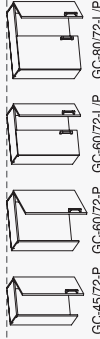

GC-45/72-P GC-60/72-P GC-80/72-LP GC-90/72-LP

sink units

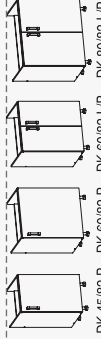

DK-45/82-P DK-60/82-P DK-80/82-LP DK-90/82-LP



DKSM/5-45/82-S/B
DKST/5-45/82-S/B



DKSM/5-60/82-S/B
DKST/5-60/82-S/B



DSM/5-30/82-S
DST/5-30/82-S/S



DSM/5-60/82-S/S
DST/5-60/82-S/S/S

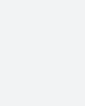

DSM/5-90/82-S/S
DST/5-90/82-S/S/S



DSM/5-45/82-S/S
DST/5-45/82-S/S/S



DSM/5-60/82-S/S
DST/5-60/82-S/S/S

corner units

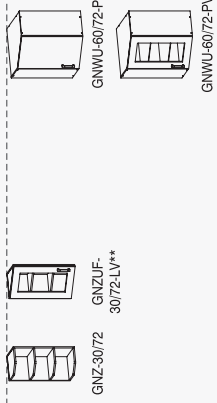
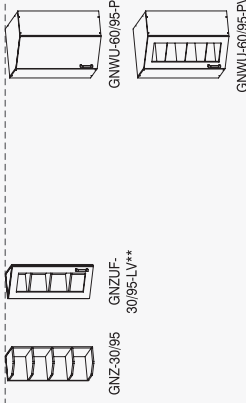

for housing domestic appliances

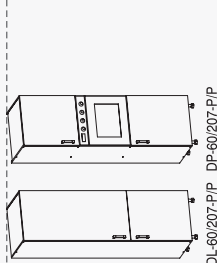
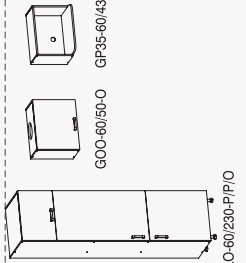

up to height of **207 cm** + cornice

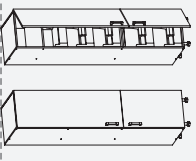

D-45/207-P/P
DSW/5-45/207-P/P



DNW-105/82-P
DNWU-90/82-P

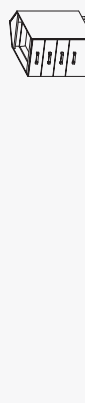

DBNW45-4/82
DBNW60-5/82
DBNWU75-90/82-S/S

corner units

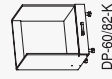

DP-60/82-K

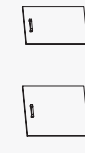

DM-60/71
DM-45/71



DM-60/57
DM-45/57

** available in doors Rosa, Ledo, Dekorado and KARTA, FALLA and PORTAL
*** available in doors Rosa, Ledo, Meios and KARTA, FALLA and PORTAL

for housing domestic appliances

BRW classic floor types

BLACK RED WHITE □

Classic LINE



SYSTEM IN A NUTSHELL SPK 2007

decorative infill panels in Royal group



[11] STRATEGIO XI
MĄDRY

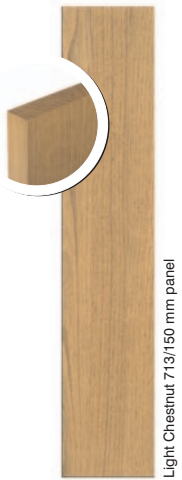

Light Chestnut 713/150 mm panel

[22] IMPEROR XXII
ŁASKAWY



Walnut 713/150 mm panel

[25] TRONIUSZ XXV
SPRAWIEDLIWY



Chestnut 713/150 mm panel

[14] INSYGNATA XIV
DUMNA

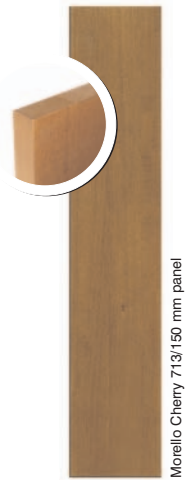

Morello Cherry 713/150 mm panel

[15] ARTYCJA XV
DOBRA

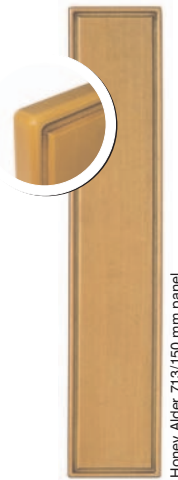

Honey Alder 713/150 mm panel

[16] DIADEMA XVI
PIĘKNA

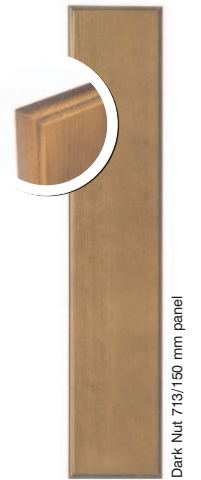

Dark Nut 713/150 mm panel

decorative infill panels in CAPITAL group



34th Avenue

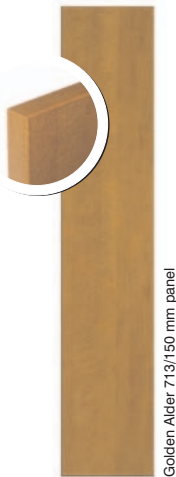

Golden Alder 713/150 mm panel

35th Avenue

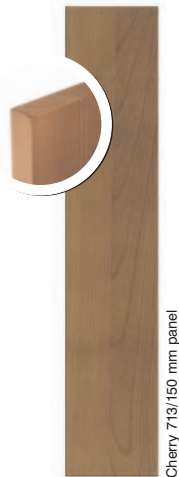

Cherry 713/150 mm panel

36th Avenue

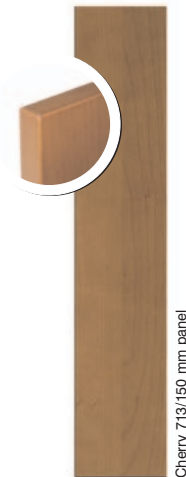

Cherry 713/150 mm panel

application of infill panels

as an additional item, decorative infill panels are available. They are made from same material, colour and thickness as a door for particular group. They are available in two sizes:

- 713/150-B, - wall units
- 943/150-B, - base units

The infill panels are designed to fulfil empty space, which cannot be achieved by the use of standard elements, e.g. between cabinet and wall.

After trimming to an appropriate length and width, the infill panel should be installed with cutting line facing the wall. Please note, that the trimmed edge, should be fitted next to the wall (please see the installation methods sketch 1).

Note: All infill panels should be fitted during kitchen installation works.

installation methods

1 the infill panel is attached to the filler panel fitted between the wall and the carcass

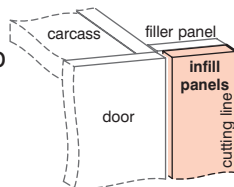

2 the infill panel is an element of non-typical cabinets, which installed, allows to utilise space behind or at the side of the door

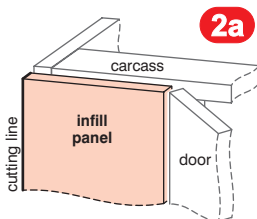

door mounted as in cabinet
DNW-105/82-L (-P)

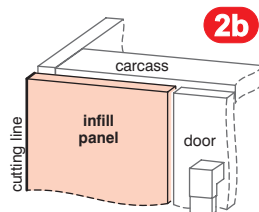

door mounted to the side of cabinet

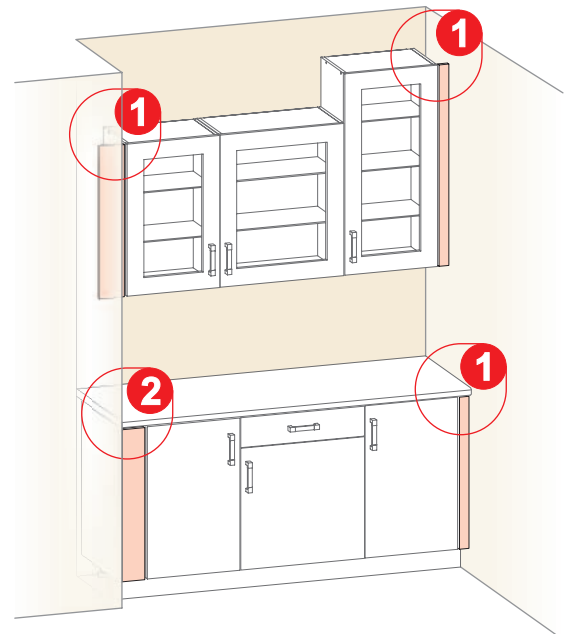

glazing dimensions

classic doors

door	KARTA	FALA	PORTAL	ARKADA	Rosa	Ledo
	glazing dimensions*	glazing dimensions*	glazing dimensions*	glazing dimensions*	glazing dimensions*	glazing dimensions*
250/446	148 x 344	148 x 344	---	134 x 330	---	---
284/896	182 x 794	182 x 794	---	168 x 780	---	---
355/446	253 x 344	253 x 344	253 x 344	239 x 330	239 x 330	253 x 344
355/596	253 x 494	253 x 494	253 x 494	239 x 480	239 x 480	253 x 494
615/446	---	506 x 344	---	---	---	---
620/446	513 x 344	---	513 x 344	504 x 330	442 x 330	513 x 344
713/396	611 x 294	611 x 294	611 x 294	597 x 280	597 x 280	611 x 294
713/430	611 x 328	611 x 328	611 x 328	597 x 314	597 x 314	611 x 328
713/446	611 x 344	611 x 344	611 x 344	597 x 330	597 x 330	611 x 344
713/596	611 x 494	611 x 494	611 x 494	597 x 480	597 x 480	611 x 494
943/396	841 x 294	841 x 294	841 x 294	827 x 280	827 x 280	841 x 294
943/430	841 x 328	841 x 328	841 x 328	827 x 314	827 x 314	841 x 328
943/446	841 x 344	841 x 344	841 x 344	827 x 330	827 x 330	841 x 344
943/596	841 x 494	841 x 494	841 x 494	827 x 480	827 x 480	841 x 494
1055/446	953 x 344	953 x 344	---	939 x 330	---	---
1055/596	953 x 494	953 x 494	---	939 x 480	---	---
1261/446	1159 x 344	1159 x 344	---	1145 x 330	---	---

* dimensions are given in mm

modern doors

door	FORMA
	glazing dimensions*
250/446	148 x 344
284/896	182 x 794
355/446	253 x 344
355/596	253 x 494
355/896	253 x 794
713/396	611 x 294
713/430	611 x 328
713/446	611 x 344
713/596	611 x 494
943/396	841 x 294
943/430	841 x 328
943/446	841 x 344
943/596	841 x 494
1055/446	953 x 344
1055/596	953 x 494
1261/446	1159 x 344

* dimensions are given in mm

indexes of glazing to classic doors

door	glazing	example index	windows for cabinet GB/5-90/72-LV/PV/B	
			door dimensions*	index
KARTA	Clear	K04-SZKŁO-BK-CZ_UNI_713X446-SZK01	620/446	K04-SZKŁO-BK-CZ_UNI_620X446-SZK01
	Rough	K04-SZKŁO-BK-MR_UNI_713X446-SZK01		K04-SZKŁO-BK-MR_UNI_620X446-SZK01
	Frosted with an Ellipse	K04-SZKŁO-BK-ME_KAR_713X446-SZK01		K04-SZKŁO-BK-ME_KAR_620X446L-SZK01**
FALA	Clear	K04-SZKŁO-BK-CZ_UNI_713X446-SZK01	615/446	K04-SZKŁO-BK-CZ_FAL_615X446-SZK01
	Rough	K04-SZKŁO-BK-MR_UNI_713X446-SZK01		K04-SZKŁO-BK-MR_FAL_615X446-SZK01
	Frosted with an Ellipse	K04-SZKŁO-BK-ME_FAL_713X446-SZK01		K04-SZKŁO-BK-ME_FAL_615X446L-SZK01**
PORTAL	Clear	K04-SZKŁO-BK-CZ_UNI_713X446-SZK01	620/446	K04-SZKŁO-BK-CZ_UNI_620X446-SZK01
	Rough	K04-SZKŁO-BK-MR_UNI_713X446-SZK01		K04-SZKŁO-BK-MR_UNI_620X446-SZK01
	Frosted with an Ellipse	K04-SZKŁO-BK-ME_PO_713X446-SZK01		K04-SZKŁO-BK-ME_PO_620X446L-SZK01**
ARKADA	Clear	K04-SZKŁO-BK-CZ_ARK_713X446-SZK01	620/446	K04-SZKŁO-BK-CZ_ARK_620X446-SZK01
	Rough	K04-SZKŁO-BK-MR_ARK_713X446-SZK01		K04-SZKŁO-BK-MR_ARK_620X446-SZK01
	Frosted with an Ellipse	K04-SZKŁO-BK-ME_ARK_713X446-SZK01		K04-SZKŁO-BK-ME_ARK_620X446L-SZK01**
Rosa	Clear	K04-SZKŁO-BK-CZ_ARK_713X446-SZK01	620/446	K04-SZKŁO-BK-CZ_RO_620X446-SZK01
	Rough	K04-SZKŁO-BK-MR_ARK_713X446-SZK01		K04-SZKŁO-BK-MR_RO_620X446-SZK01
	Frosted with an Ellipse	K04-SZKŁO-BK-ME_RO_713X446-SZK01		K04-SZKŁO-BK-ME_RO_620X446-SZK01
Ledo	Clear	K04-SZKŁO-BK-CZ_UNI_713X446-SZK01	620/446	K04-SZKŁO-BK-CZ_UNI_620X446-SZK01
	Rough	K04-SZKŁO-BK-MR_UNI_713X446-SZK01		K04-SZKŁO-BK-MR_UNI_620X446-SZK01
	Frosted with an Ellipse	K04-SZKŁO-BK-ME_KAR_713X446-SZK01		K04-SZKŁO-BK-ME_KAR_620X446L-SZK01**

* dimensions are given in mm, ** glass is available as left and right

indexes of glazing for modern doors

door	glazing	example index
FORMA	Master	K04-SZKŁO-BK-MA_FOR_713X446-SZK01
	Frosted	K04-SZKŁO-BK-ML_FOR_713X446-SZK01
	Frosted with a Rectangle Pattern	K04-SZKŁO-BK-MP_FOR_713X446-SZK01

carcass colours



4

Medium Chestnut (KAS)



4

Chestnut (KA)



5

Nida Maple (KLN)



5

Milan Oak (DMI)



5

Beech (BU)

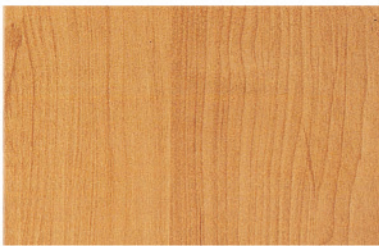

5

San Alder (OLS)



5

Portofino Cherry (WISP)

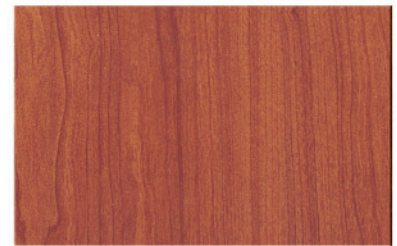

5

Electra Cherry (WIEL)

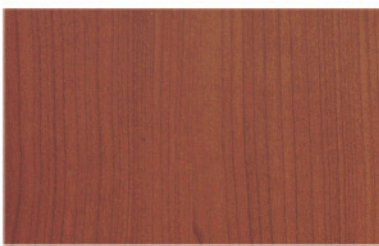

5

Elba Cherry (WISE)

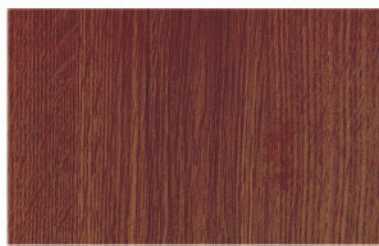

5

Windsor Oak (DW)

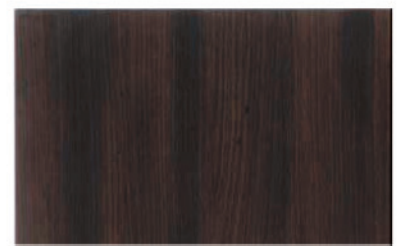

5

Wenge (WE)

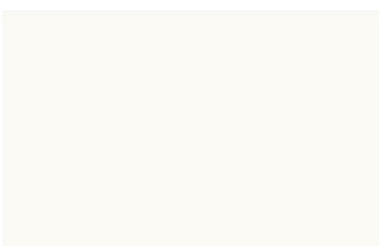

5

White (BI)

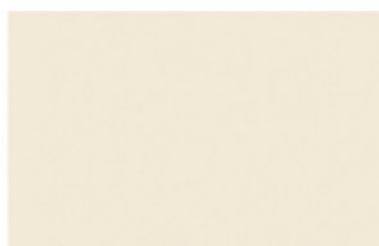

5

Beige (BE)

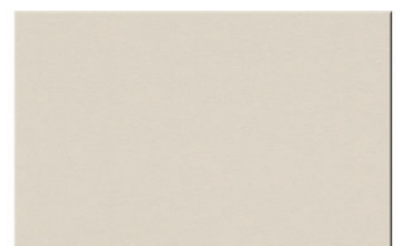

5

Grey (SZ)

combination of carcass / door for kitchens of the Royal, CAPITAL, Sentima and TRAFFIC groups

carcass colour (panel)	<i>Royal</i>						CAPITAL			<i>Sentima</i>					TRAFFIC										
	11	22	25	14	15	16	34	35	36	3	3P	4	7	9	12	41	46	51	56	61	71	72	74	75	76
Beech										o	o	X	o	o	o	X	o	X	o	X	X	X	X	o	o
Windsor Oak						X				o	o	X	o	X	o	X	o	X	o	o	X	X	o	o	o
San Alder					X					X	X	X	X	o	o	X	o	X	o	X	X	X	o	X	o
Electra Cherry										o	o	X	o	o	X	X	X	X	X	o	X	X	o	o	X
Elba Cherry							o	X	X																
Portofino Cherry				X			X	o	o																
Chestnut		X																							
Medium Chestnut	X		X																						
white	METABOX drawer bottom									METABOX drawer bottom															
window	TANDEMBOX drawer bottom																								

combination of carcass / door for kitchens of the Classic Line, Modern Line and BRW Line groups

carcass colour (panel)	<i>Classic</i>		<i>Modern</i>										BRW LINE
	<i>Rosa</i> <small>Cherry Antique Palms</small>	<i>Melos</i> <small>Orange Birch</small>	<i>Diona</i> <small>Wenge</small>	<i>Diona</i> <small>Milan Oak</small>	<i>Diona</i> <small>Golden Cherry</small>	<i>Hedar</i> <small>Wenge</small>	<i>Hedar</i> <small>Milan Oak</small>	<i>Hedar</i> <small>Golden Cherry</small>	<i>Telesto</i> <small>Wenge</small>	<i>Telesto</i> <small>Milan Oak</small>	<i>Telesto</i> <small>Golden Cherry</small>	<i>Telesto</i> <small>Nida Maple</small>	all types of doors
Beech ¹⁾	o	o	o	o	o	o	o	o	o	o	o	o	o
Milan Oak	o	o	X	X	o	X	X	o	X	X	o	o	o
Windsor Oak	o	o	o	o	o	o	o	o	o	o	o	o	o
Nida Maple	o	o	o	o	o	o	o	o	o	o	o	X	o
San Alder	o	o	o	o	o	o	o	o	o	o	o	o	o
Wenge	o	o	X	X	o	X	X	o	X	X	o	o	o
Elba Cherry	X	X	o	o	X	o	o	X	o	o	X	o	o
Electra Cherry	X	o	o	o	X	o	o	X	o	o	X	o	o
Portofino Cherry ²⁾	o	o	o	o	o	o	o	o	o	o	o	o	o
White	o	o	o	o	o	o	o	o	o	o	o	o	o
Beige	o	o	o	o	o	o	o	o	o	o	o	o	o
Grey	o	o	o	o	o	o	o	o	o	o	o	o	o
white	bottom and back of METABOX drawers												
window	TANDEMBOX drawer bottom												

X - suggested arrangement

o - permitted arrangement

1) - in standard only METABOX drawers

2) - in standard only TANDEMBOX drawers

colours of bottom panels (back) of drawers



cabinet construction for the example D1ST/5-45/82-P/S

carcass

The carcasses (with the exception of back panels) and shelves are made of chipboard 16 mm thick laminated both sides in 14 different colours. Carcass colours and their combination with doors are shown on p. 50-51.

Carcasses are assembled with the aid of screws connectors made of blunt long threaded eccentric type screws and wooden pegs.

back panel

Made of fibre board panels in lower cabinets as in upper cabinets the backs are let in.

drawers

Two types of drawers are offered: METABOX and TANDEMBOX, produced by Blum.

The particular characteristics are presented on the next page.

edges

front edges (visible) of carcass are glued on panels have a PVC rim of 0.6 mm thickness.

dimensions

Cabinets are made in a 15 cm module (widths are multiples of 15 cm).

The basic widths of cabinets are 15, 30, 45, 60 and 90 cm (in CAPITAL group there are also cabinets of width 120 cm).

Exceptions are cabinets of widths 50 and 80 cm available in Sentima, TRAFFIC, Classic Line, Modern Line and BRW Line groups.

The depth of carcasses of lower base units is 508 mm or 560 mm (details in section **Cabinets in SPK** at the end of the catalogue)

depths of carcasses of upper wall units are 300 mm.

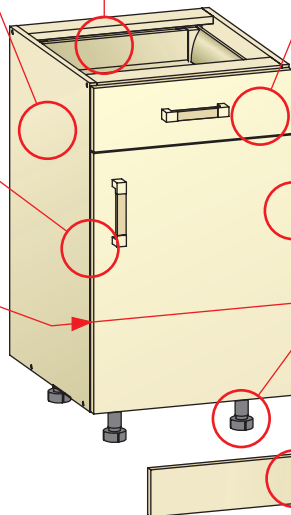

hinges

Similarly to the drawers are produced by Blum.

The basic hinge is MODUL, and a supplementing hinge CLIP is applied e.g. in DNW cabinets (opposite page).

legs

As standard on all lower base units there are attached three element adjustable legs of a height of 10 cm;

The legs extensions are available, which could raise overall height of the unit by 50mm and two types of ornamental legs of height 15 cm (adjustable).

More details on page 102.

plinth

standard height 10 cm made of chipboard # 16 mm in the colour of the carcass.

Plastic plinths are also available: in silver (height 10 or 15 cm), Portofino Cherry (height 10 cm), and also curved plinths for DNZR type cabinets

More details on page 60-61.

hanging cabinets (wall units)

Wall units (with the exception of external corner units) are equipped with adjustable hangers and mounting panels.

Panels may replace mounting strips (additional offer).

index structure

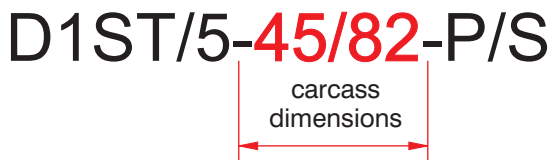
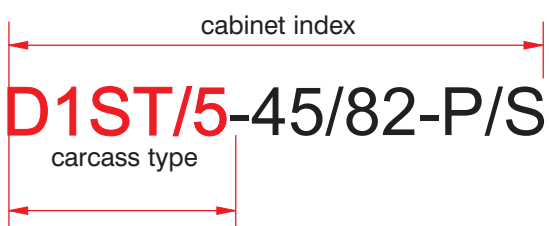

index codes

D1ST/5 - lower cabinet carcass with 5-drawer arrangement
45/82 - cabinet width 45 cm, cabinet height 82 cm
P/S - in cabinet are fitted (counting from the bottom):
 right door
 drawer

abbreviation dictionary

A - aluminium	N - corner unit
A - narrow aluminium glazed door	O - hood or hood door
A3 - wide aluminium glazed door	P - right or oven
B - blend	PE - right bow
C - cargo or drainer unit	R - rounded
CC - cargo (high)	ROL - roller blind
D - base units	S - drawer
E - blender arch	SM - METABOX drawer
F - with door	ST - TANDEMBOX drawer
G - wall units	SW - internal drawer
H - lattice	T - standing on worktop
I - pilaster	U - bevelled
K - under sink, flap or crown	V - glazed door
L - left or refrigerator	W - internal
LE - left bow	X - METABOX drawer, other
M - dish washer	Y - wicker basket
	Z - external

METABOX drawer

- partial pull out;
- ability to adjust door;
- self-closing system;
- ability to lock drawer in open position;
- load capacity to 30 kg;
- cream-white colour of drawer side;
- drawer side heights applied:
 - N (54 mm) - for oven,
 - M (86 mm) - standard drawer;
 - M (86 mm) + railing - drawer with high door;
- usage test - 100 000 cycles;
- lifetime quality guarantee

ATTENTION: METABOX drawers are sold without stoppers.



TANDEMBOX drawer



- full pull out;
- adjustment of door in three dimensions;
- self-closing system;
- quiet and delicate movement on TANDEM hidden guides;
- BLUMOTION quiet self-closing system;
- load capacity to 30 or 50 kg;
- drawer sides grey coloured;
- drawer side heights applied:
 - N (68 mm) - for oven,
 - M (83 mm) - standard drawer;
 - M (83 mm) + railing + box side - drawer with high door;
- additional accessories organising drawer interior;
- usage test 100 000 cycles;
- lifetime quality guarantee



MODUL basic hinge;

- nickel metal hinge;
- hinge seat of diameter 35 mm;
- self-closing system;
- adjustable in three dimensions;
- opening angle and 100°;
- inserted hinge arm;
- usage test 200 000 cycles;
- lifetime quality guarantee



CLIP supplementary hinge

- nickel metal hinge;
- hinge seat of diameter 35 mm*;
- self-closing system;
- adjustable in three dimensions;
- mounting and dismantling door from carcass without the use of tools;
- four types of Clip hinges:
 - hinge -45°, **GNZUF**,
 - hinge 45° - **DNZUF, DNWU, GNWU**,
 - hinges 125° + 170° - **DNW (90/82), GNW**,
 - hinge for parallel doors - **DNZRF, DNZU2F**,
 - wide opening hinge - **DSWT**,
 - hinge for aluminium frames **VA**;
- usage test 200 000 cycles;
- lifetime quality guarantee



ATTENTION:
hinges are sold without stoppers.
* with the exception of hinged VA frames

layouts for 4- and 5-drawer arrangements

layouts for 4- and 5-drawer arrangements tell us how many drawers of equal height may be fitted in a lower base unit of door height 713 mm.

DRAWER DIVISION FOR FOUR

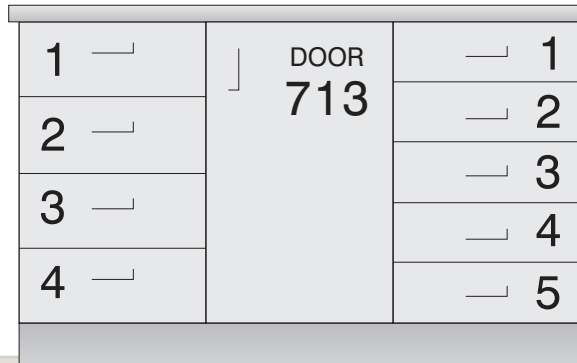

DRAWER DIVISION FOR FIVE



The result of the applied division are various for different drawer heights. In a 4-drawer layout the basic door amounts to 176 mm, and in a 5-drawer layout 140 mm. All remaining differences of door heights, which arise from application of 4- or 5-drawer layouts are given in the sketch below.

NOTE: each horizontal line between individual doors/doors should be counted as a gap of 3mm.

characteristic door heights for a 4-drawer layout

DRAWER DIVISION FOR FOUR

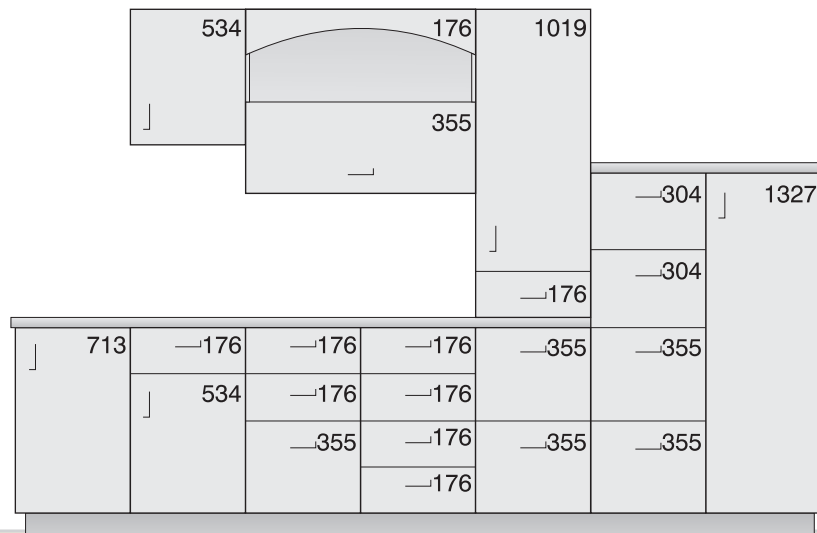

characteristic door heights for a 5-drawer layout

DRAWER DIVISION FOR FIVE

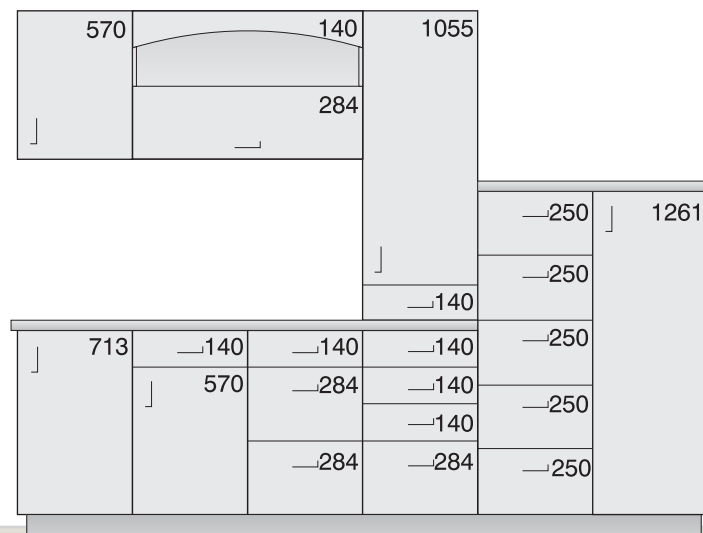

cabinet heights in a 4-drawer layout
heights available only for a 4-drawer layout are written in red

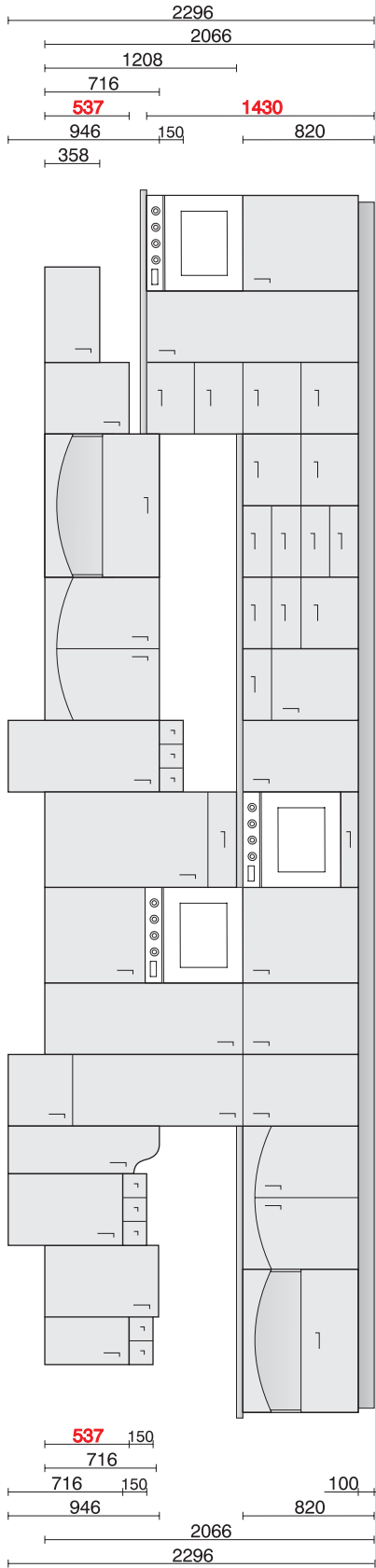

4

cabinet heights in a 5-drawer layout
heights available only for a 5-drawer layout are written in red

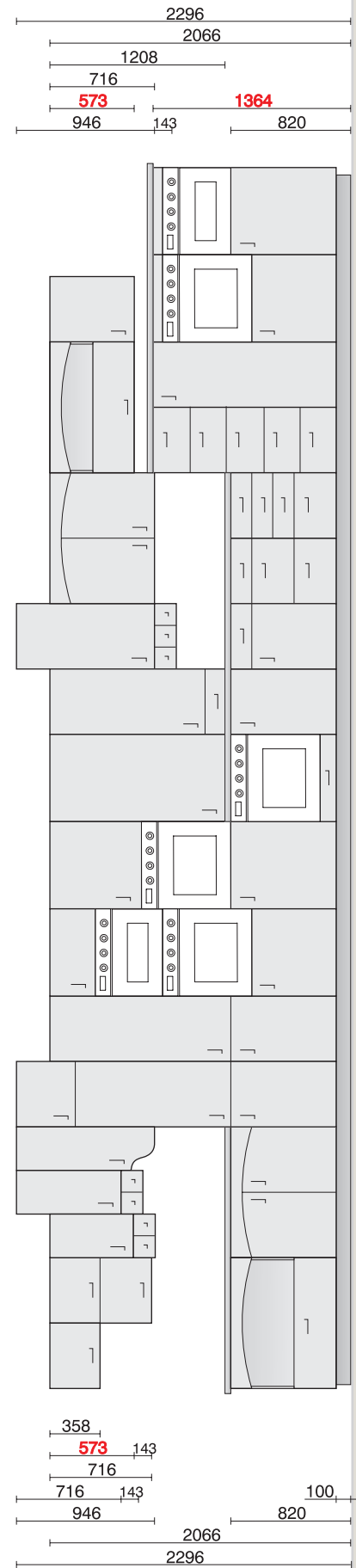

5

cabinets for housing refrigerators

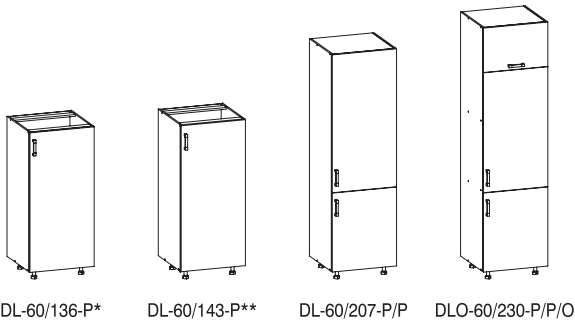

doors for under worktop housing

doors are designated mainly for dishwashers, but door DM-60/71 may be equally applied to refrigerator, freezer and washing machine under worktop housing.

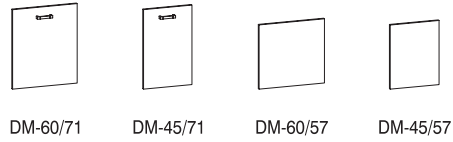

cabinet for housing telescopic hoods



GOO-60/50-O****

cabinet was designed for hood **CBT 62/1 AX (Candy)**.

mounting of other hood models of type SLIM (telescopic) may require cabinet adaptation

cabinet for oven housing

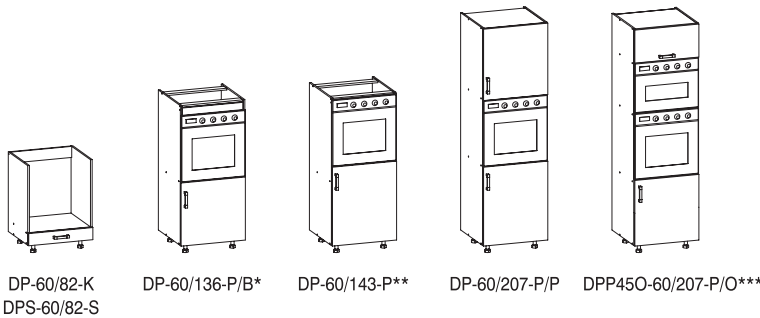

cabinet for housing kitchen microwaves

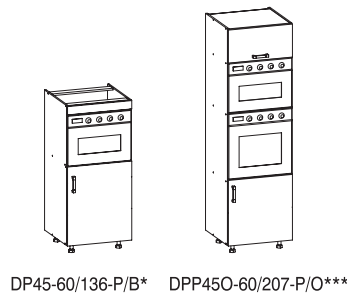

shelf for freestanding kitchen microwaves



GP35-60/43

* appears in groups Royal/5, CAPITAL, Sentima and TRAFFIC

** appears in group Royal/4

*** appears in groups Royal/5, CAPITAL, Sentima, TRAFFIC, Modern Line and BRW Line modern doors

**** appears in groups Royal/5, CAPITAL, Sentima, TRAFFIC, Classic Line, Modern Line and BRW Line

fitting domestic appliances in to cabinets

When choosing domestic appliances for fitting in cabinets, their measurements for the cabinets should be checked. Particular attention should be given to refrigerators and kitchen microwaves.

refrigerator selection

When selecting refrigerators for cabinets is recommended that we check:

- 1) whether the refrigerator model is designated for fitting in cabinets,
- 2) if the refrigerator will fit in cabinet
(domestic appliances producers give minimum cabinet interior sizes, these dimensions should be compared with the cabinet dimensions shown opposite),
- 3) the size of cabinet door and refrigerators door to be placed inside
(space between refrigerator doors should be at the height of the gap between cabinet doors; at times to match refrigerators to cabinets it is enough to lift them by a few centimetres).

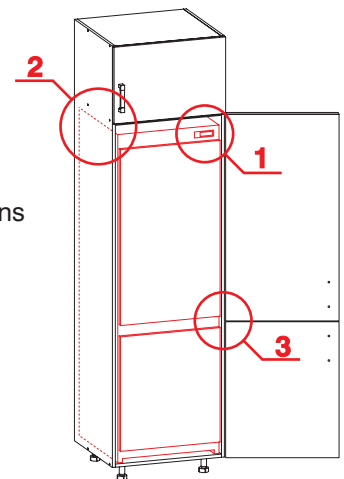

kitchen microwave selection

Kitchen microwaves for fitting in cabinets are available in various heights. Cabinets produced by Black Red White are adapted to heights "45" (P45 in cabinet index signifies kitchen microwave "45").

When placing an order remember to compare the internal dimensions of cabinets with the requirements of the kitchen microwave producer.

>>> **ATTENTION: freestanding domestic appliances are not suitable for fitting in cabinets.** <<<

FOR REFRIGERATORS

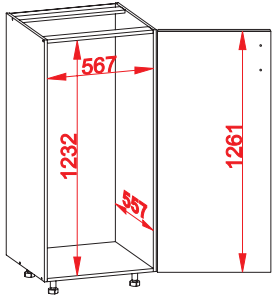

DL-60/136-P*

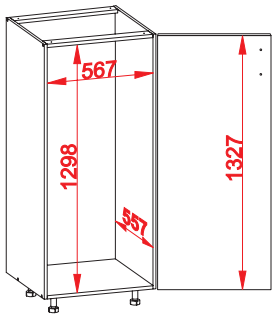

DL-60/143-P**

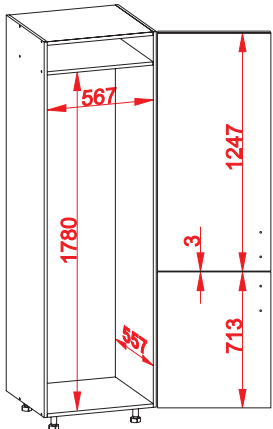

DL-60/207-P/P

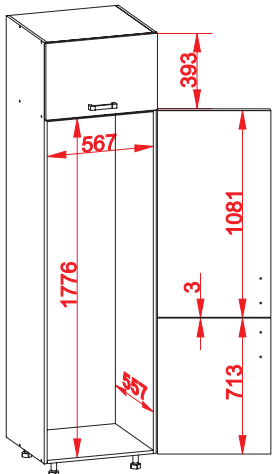

DLO-60/230-P/P/O

FOR FREESTANDING KITCHEN MICROWAVES

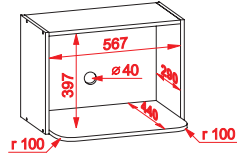

GP35-60/43

FOR TELESCOPIC HOODS (SLIM)

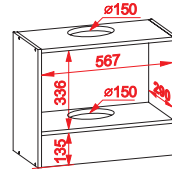

GOO-60/50-O****

FOR OVENS

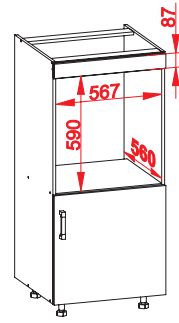

DP-60/136-P/B*

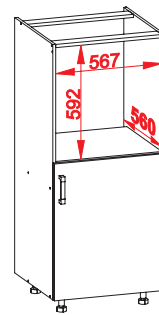

DP-60/143-P**

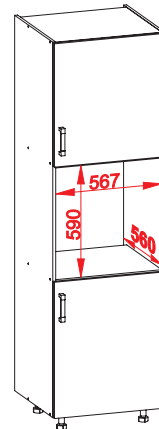

DP-60/207-P/P

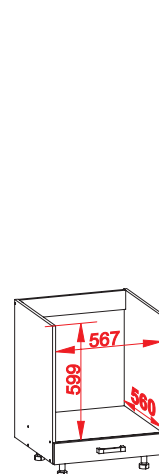

DP-60/82-K
DPS-60/82-S

FOR KITCHEN MICROWAVES

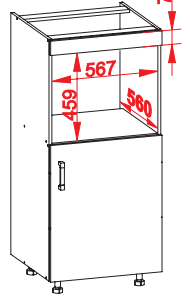

DP45-60/136-P/B*

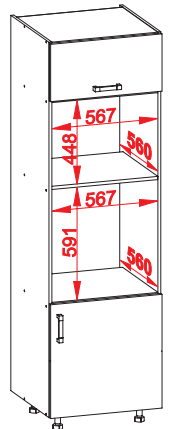

DPP450-60/207-P/O****

* available in groups Royal/5, CAPITAL, Sentima and TRAFFIC
 ** available in group Royal/4
 *** available in groups Royal/5, CAPITAL, Sentima, TRAFFIC, Modern Line and BRW Line modern doors
 **** available in groups Royal/5, CAPITAL, Sentima, TRAFFIC, Classic Line, Modern Line and BRW Line

FOR REFRIGERATORS
 ADAPTED TO STANDARD OF BOSCH, SIEMENS, GORENJE
 AND OTHER BRANDS

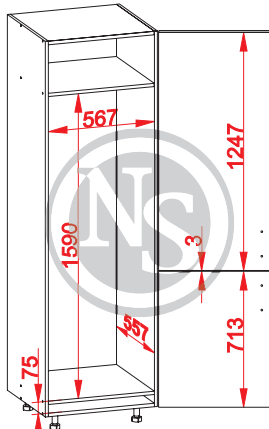

DL/NT160-60/207-P/P

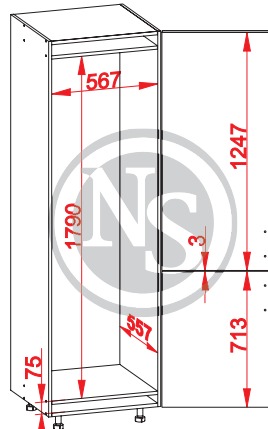

DL/NT180-60/207-P/P

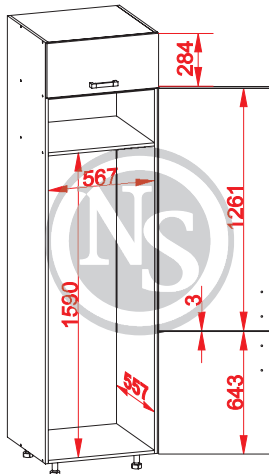

DL/NT160-60/230-P/P/O*

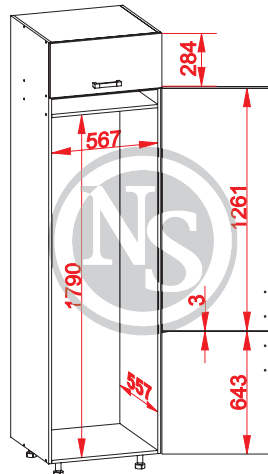

DL/NT180-60/230-P/P/O*

FOR OVENS
 AND KITCHEN MICROWAVES

non-standard cabinets

Non-standard cabinets have technical documentation drawn up and are priced. Because of the modest turnover they are made after receipt of order for the given cabinet.



for housing refrigerators

DL/NT type cabinets for housing refrigerators are made to accomodate standard appliances e.g. Bosch, Siemens and Gorenje.

Please note: not all refrigerators of the above brands are suited to DL/NT type cabinets. On completion of order check internal dimensions of cabinets (p. 57) with the dimensions given by the domestic appliance manufacture.

In DL/NT cabinets all doors have standard measurements, but some have a changed drilled hole arrangement.

In the list doors with non-standard drill holes are marked in bold print.

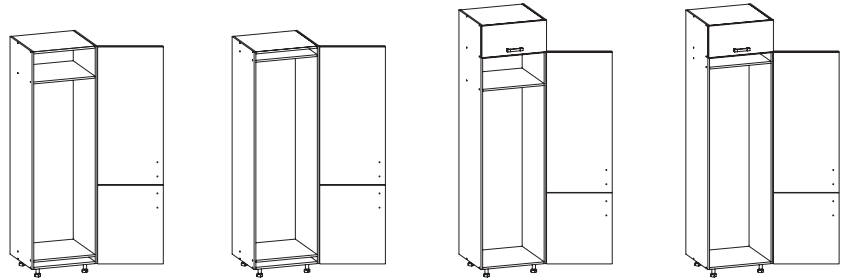

DL/NT160-60/207-P/P
doors

713/596-NT (-LNT, -PNT)
1247/596 (-L, -P)

DL/NT180-60/207-P/P
doors

713/596-NT (-LNT, -PNT)
1247/596-NT (-LNT, -PNT)

DL/NT160-60/230-P/P/O*
doors

643/596 (-L, -P)
1261/596 (-L, -P)
284/596-O

DL/NT180-60/230-P/P/O*
doors

643/596 (-L, -P)
1261/596-NT (-LNT, -PNT)
284/596-O

* appearing groups
Royal/5, CAPITAL, Sentima and TRAFFIC



corner units of worktop panels

Corner units are made of worktop panels:

28 mm (San Alder, Beige Pietra),

38 mm (Sanenberg Beech, Brick, Royal Granite, Mint, San Alder, Sandstone, Beige Pietra).

Corner cabinets with the above worktop panels with edges finished in melamine are offered at the prices of corner units of carcass panels # 16 mm.

Corner cabinets made of other panels and / or finished with PVC rim are priced as non-typical cabinets.

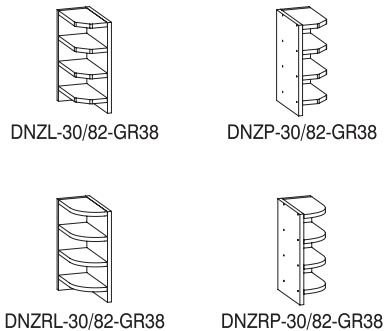

non-typical cabinets on request

Non-typical cabinets are made according to the sketch and description provided by client / designer. Non-typical cabinets are made according to drawing and description provided by client / designer. Because of the individual character of each non-typical cabinet they are priced individually.

When ordering non-typical cabinets several principles shall be applied:

- 1) cabinet should be based on typically available cabinets
- 2) cabinet can only be made of materials used for production of Black Red and White kitchen furniture.
- 3) accessories applied should come from standard Black Red White kitchen cabinets.
- 4) doors fitted to non-standard cabinets should be standard.
- 5) construction must be stable (cabinet can not be e.g. too large),
- 6) order should be placed on a non-typical order form. (example order is shown on the next page).

Please note: order form is for making non-typical carcasses. Doors, even if shown on the drawing shall be ordered separately.



example of non-typical order - narrowing of typical cabinet

for modest adaptations such as narrowing or making cabinets shallower it is enough to describe the measurements that shall be made for the given cabinet.

PROJECTION FROM THE DOOR	PROJECTION FROM THE SIDE
	<p style="font-size: 48px; transform: rotate(-15deg); opacity: 0.5;">without change</p>
PROJECTION FROM ABOVE	NON-TYPICAL DESCRIPTION
	<p>kitchen <u>[15] Artycja XV Dobra</u></p> <p>carcass colour <u>San Alder</u></p> <p>based on carcass <u>D-90/82-L/P</u></p> <p>rear finishing* <u>without change</u></p> <p>doors applied <u>713/446-L</u> <u>713/396-P</u></p> <p>additional comments <u>Z</u></p> <p><small>* suggested finishing: fibre board, glued to back without sides, furniture filler panel # 16 mm</small></p>

plinths made in carcass colours



straight plinth height 100 mm, colour San Alder chipboard panel



straight plinth height 150 mm, colour San Alder chipboard panel

plinth of filler panel #16mm with PVC rim glued on one edge

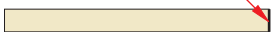

curved plinth "100" colour Portofino Cherry, plastic



curved plinth "100" (colour San Alder, plastic) with joiner



curved plinth "150" colour San Alder, MDF panel



sealant

product description	available lengths*	colour	index
straight plinth, height 100 mm, length 2000 mm made of chipboard panels # 16 mm ATTENTION: during installation the plinth should be protected by a sealant plinths of fibre board panel in non-standard measurements should be ordered a filler panel description on p. 62		Beige	K04-COKOL-BE-CP2000-KOR01
		White	K04-COKOL-BI-CP2000-KOR01
		Beech	K04-COKOL-BU-CP2000-KOR01
		Milan Oak	K04-COKOL-DMI-CP2000-KOR01
		Windsor Oak	K04-COKOL-DW-CP2000-KOR01
		Chestnut	K04-COKOL-KA-CP2000-KOR01
		Medium Chestnut	K04-COKOL-KAS-CP2000-KOR01
		Nida Maple	K04-COKOL-KLN-CP2000-KOR01
		San Alder	K04-COKOL-OLS-CP2000-KOR01
		Wenge	K04-COKOL-WE-CP2000-KOR01
		Elba Cherry	K04-COKOL-WISE-CP2000-KOR01
		Electra Cherry	K04-COKOL-WIEL-CP2000-KOR01
		Portofino Cherry	K04-COKOL-WISP-CP2000-KOR01
		Grey	K04-COKOL-SZ-CP2000-KOR01
straight plinth, height 150 mm, length 2000 mm made of filler panel # 16 mm ATTENTION: during installation the plinth should be protected by a sealant plinths of chipboard panel in non-standard measurements should be ordered as filler panel description on p. 62		Beige	K04-COKOL-BE-CP2000/150-KOR01
		White	K04-COKOL-BI-CP2000/150-KOR01
		Beech	K04-COKOL-BU-CP2000/150-KOR01
		Milan Oak	K04-COKOL-DMI-CP2000/150-KOR01
		Windsor Oak	K04-COKOL-DW-CP2000/150-KOR01
		Chestnut	K04-COKOL-KA-CP2000/150-KOR01
		Medium Chestnut	K04-COKOL-KAS-CP2000/150-KOR01
		Nida Maple	K04-COKOL-KLN-CP2000/150-KOR01
		San Alder	K04-COKOL-OLS-CP2000/150-KOR01
		Wenge	K04-COKOL-WE-CP2000/150-KOR01
		Elba Cherry	K04-COKOL-WISE-CP2000/150-KOR01
		Electra Cherry	K04-COKOL-WIEL-CP2000/150-KOR01
		Portofino Cherry	K04-COKOL-WISP-CP2000/150-KOR01
		Grey	K04-COKOL-SZ-CP2000/150-KOR01
curved plinth, height 100 mm, left for cabinet DNZRLF-30/82-L/LR curved plinth strip is made of plastic and finished with sealant thickness 12 mm		Windsor Oak	K04-COKOL-DW-LCGO/PL/L-KOR01
		Chestnut	K04-COKOL-KA-LCGO/PL/L-KOR01
		Medium Chestnut	K04-COKOL-KAS-LCGO/PL/L-KOR01
		San Alder	K04-COKOL-OLS-LCGO/PL/L-KOR01
		Portofino Cherry	K04-COKOL-WISP-LCGO/PL/L-KOR01
curved plinth, height 100 mm, right for cabinet DNZRPF-30/82-P/PR curved plinth is made of plastic and finished with sealant thickness 12 mm		Windsor Oak	K04-COKOL-DW-LCGO/PL/P-KOR01
		Chestnut	K04-COKOL-KA-LCGO/PL/P-KOR01
		Medium Chestnut	K04-COKOL-KAS-LCGO/PL/P-KOR01
		San Alder	K04-COKOL-OLS-LCGO/PL/P-KOR01
		Portofino Cherry	K04-COKOL-WISP-LCGO/PL/P-KOR01
curved plinth, height 150 mm for cabinets DNZRLF-30/82-L/LR and DNZRPF-30/82-P/PR curved plinth of MDF thickness 16 mm, ATTENTION: during mounting the plinth should be protected by a sealant		Windsor Oak	K04-COKOL-DW-LCGO/150-KOR01
		Chestnut	K04-COKOL-KA-LCGO/150-KOR01
		Medium Chestnut	K04-COKOL-KAS-LCGO/150-KOR01
		San Alder	K04-COKOL-OLS-LCGO/150-KOR01
		Portofino Cherry	K04-COKOL-WISP-LCGO/150-KOR01
sealant	2500, 5000	colourless	SK-BK-USZ_COKOL

* dimensions are given in mm

ATTENTION: to order we also make curved plinth strips of height 150 mm in colours Siena Cherry (application [14] Insignata XIV Dumna, joining with straight plinth strip in colour Portofino Cherry).

Because of the thickness differences in plinths of plastic and of chipboard special connectors need to be used, which are in curved plinth packets

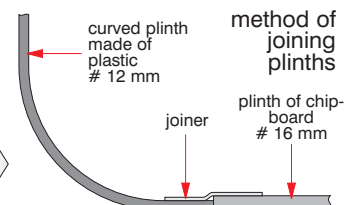

plinths of plastic and colour Portofino Cherry



straight plinth "100"
colour Portofino Cherry, plastic

product description	available lengths*	colour	index
straight plinth strip, height 100 mm made from plastic, #12 mm	2000	Portofino Cherry	K04-COKOL-WISP-PL_2000-KOR01
	4000	Portofino Cherry	K04-COKOL-WISP-PL_4000-KOR01
plinth end from plastic #12 mm		Portofino Cherry	K04-COKOL-WISP-PL_100_K_L/P-KOR01
plinth joiner from plastic #12 mm		Portofino Cherry	K04-COKOL-WISP-PL_100_LACZNIK-KOR01
90° corner to plinth from plastic #12 mm		Portofino Cherry	K04-COKOL-WISP-PL_100_NZ/NW_90-KOR01
135° corner to plinth from plastic #12 mm		Portofino Cherry	K04-COKOL-WISP-PL_100_NZ/NW_135-KOR01

* dimensions are given in mm



curved plastic plinths in colour Portofino Cherry p. 60

90° and 135° corner units are universal
- may be applied as internal or external

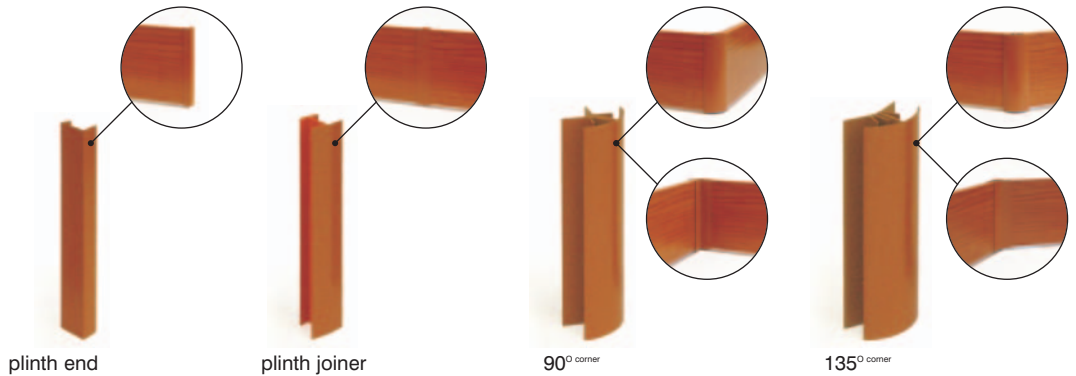

plastic plinths



silver plinth

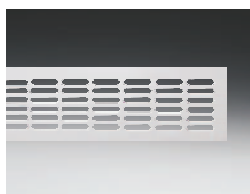

aluminium ventilation grill

product description	available lengths*	index
plinth strip in colour silver, height 100 mm	2000, 4000	SK-SRE-COKOL/PVC_100
plinth strip in colour silver, height 150 mm	2000, 4000	SK-SRE-COKOL/PVC_150
internal corner 90° to PVC plinths, height 100 mm		SK-SRE-COKOL/PVC_100_NZ90
internal corner 90° to PVC plinths, height 150 mm		SK-SRE-COKOL/PVC_150_NZ90
plinth end left / right to PVC plinths, height 100 mm		SK-SRE-COKOL/PVC_100_K_L+P
left plinth end to PVC plinths, height 150 mm		SK-SRE-COKOL/PVC_150_K_L
right plinth end to PVC plinths, height 150 mm		SK-SRE-COKOL/PVC_150_K_P
aluminium ventilation grill, height 80 mm, width 480 mm		SK-03*K.KWA-01

* dimensions are given in mm

ventilation lattices as standard

Ventilation lattices suited to carcass colours are attached to carcass package.
Loose lattices should be mounted in the top over the cabinet.

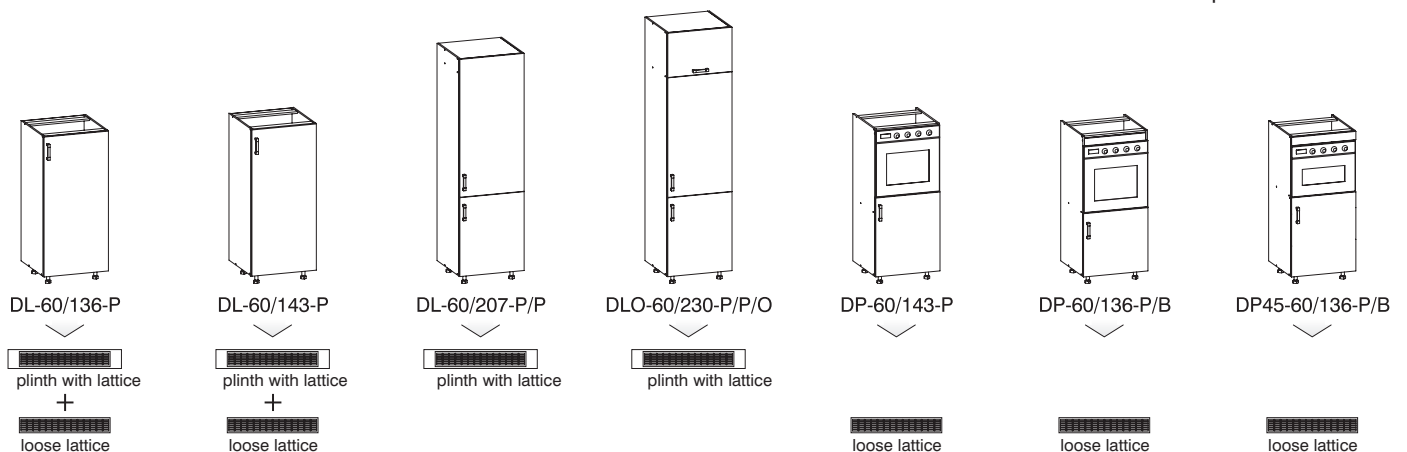

ordering plinth strips with filler panels in carcass colours according to sketch

Plinths with filler panels # 16 mm of non-typical dimensions, e.g. of length 2500 mm should be ordered according to sketch

ATTENTION:

too long plinth are due to a higher damage risk in transport. Strips are cut to measure while mounting kitchen.

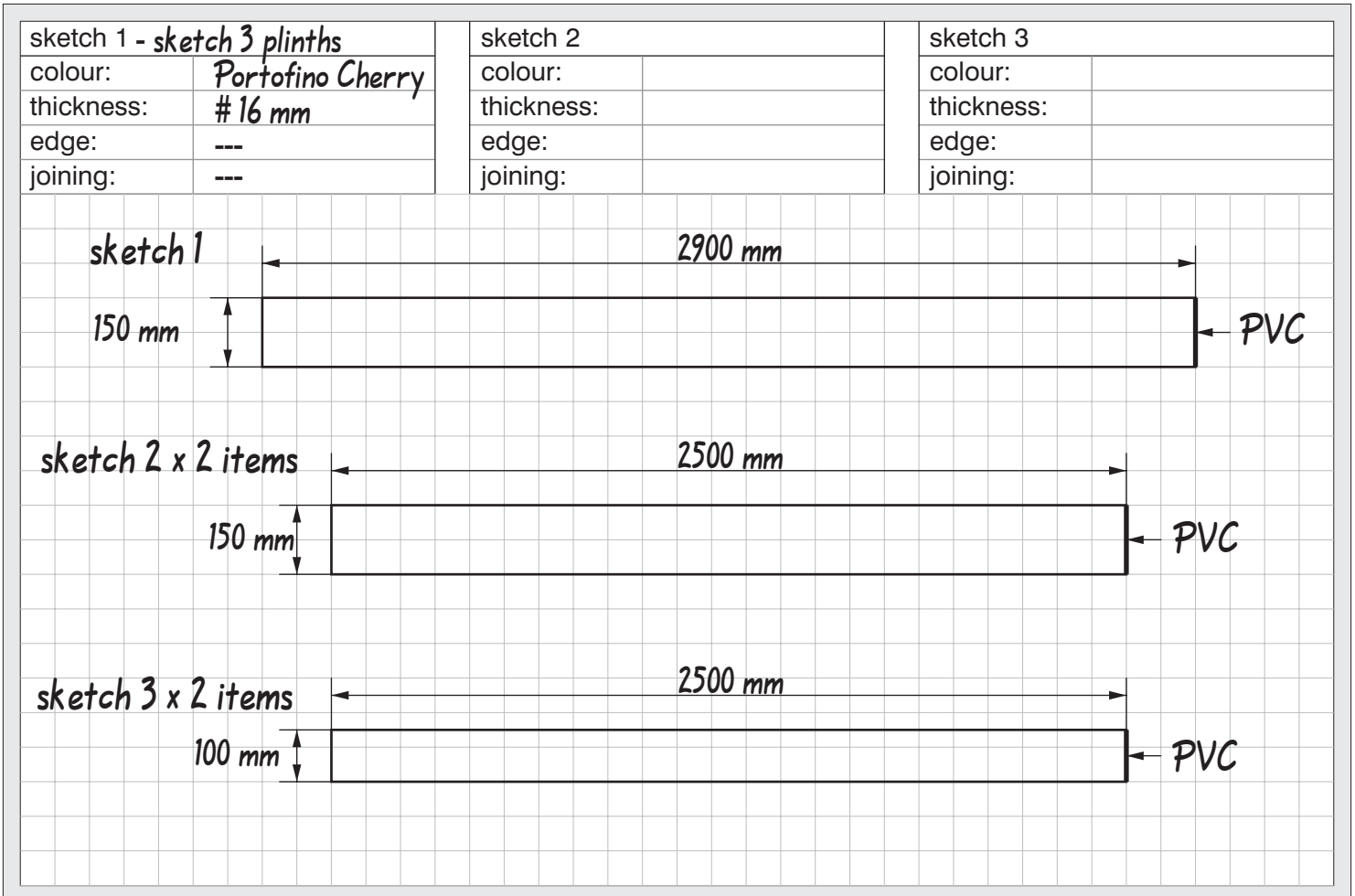

blenders with filler panels in carcass colours

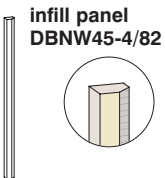

For corner housing 90 x 90 cm cabinet type DNWUST/4, DNWUST/5 or other lower cabinet of dimensions 45/82 cm (width/height).
 material: filler panel # 36 mm,
 packing: in 2 items
Please note: blender is not symmetrical, inappropriate mounting may cause difficulties in matching worktops.

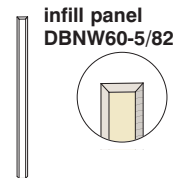

For corner housing 105 x 105 cm lower cabinet of dimensions 60/82 cm (width/height).
 material: filler panel # 36 mm,
 packing: in 2 items

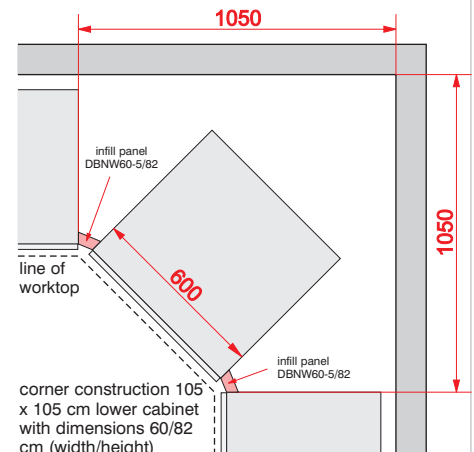
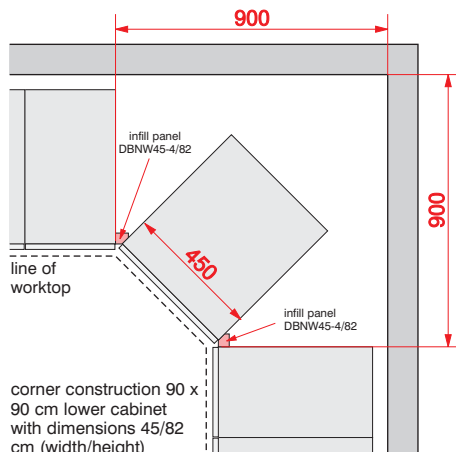
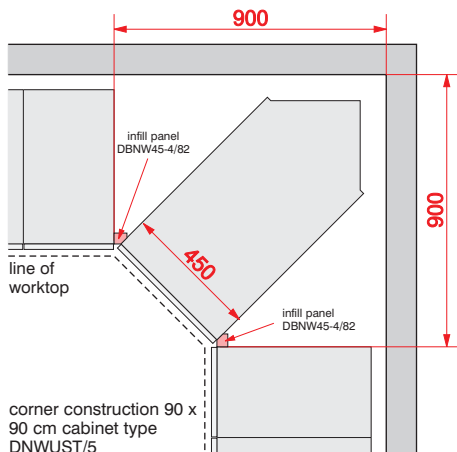

filler panels in carcass colours

product description	colour	dimensions max. * (length/width)	index
filler panel # 16 mm	Beige	4100 x 2000	K04-FORMATKA-BE-GR_16-KOR01
	White	4100 x 2000	K04-FORMATKA-BI-GR_16-KOR01
	Beech	4100 x 2000	K04-FORMATKA-BU-GR_16-KOR01
	Milan Oak	4100 x 2000	K04-FORMATKA-DMI-GR_16-KOR01
	Windsor Oak	4100 x 2000	K04-FORMATKA-DW-GR_16-KOR01
	Chestnut	4100 x 2000	K04-FORMATKA-KA-GR_16-KOR01
	Medium Chestnut	4100 x 2000	K04-FORMATKA-KAS-GR_16-KOR01
	Nida Maple	4100 x 2000	K04-FORMATKA-KLN-GR_16-KOR01
	San Alder	4100 x 2000	K04-FORMATKA-OLS-GR_16-KOR01
	Grey	4100 x 2000	K04-FORMATKA-SZ-GR_16-KOR01
	Wenge	4100 x 2000	K04-FORMATKA-WE-GR_16-KOR01
	Elba Cherry	4100 x 2000	K04-FORMATKA-WISE-GR_16-KOR01
	Electra Cherry	4100 x 2000	K04-FORMATKA-WIEL-GR_16-KOR01
	Portofino Cherry	4100 x 2000	K04-FORMATKA-WISP-GR_16-KOR01
filler panel # 36 mm	Beige	2600 x 1800	K04-FORMATKA-BE-GR_36-KOR01
	White	2600 x 1800	K04-FORMATKA-BI-GR_36-KOR01
	Beech	2600 x 1800	K04-FORMATKA-BU-GR_36-KOR01
	Milan Oak	2600 x 1800	K04-FORMATKA-DMI-GR_36-KOR01
	Windsor Oak	2600 x 1800	K04-FORMATKA-DW-GR_36-KOR01
	Chestnut	2600 x 1800	K04-FORMATKA-KA-GR_36-KOR01
	Medium Chestnut	2600 x 1800	K04-FORMATKA-KAS-GR_36-KOR01
	Nida Maple	2600 x 1800	K04-FORMATKA-KLN-GR_36-KOR01
	San Alder	2600 x 1800	K04-FORMATKA-OLS-GR_36-KOR01
	Grey	2600 x 1800	K04-FORMATKA-SZ-GR_36-KOR01
	Wenge	2600 x 1800	K04-FORMATKA-WE-GR_36-KOR01
	Elba Cherry	2600 x 1800	K04-FORMATKA-WISE-GR_36-KOR01
	Electra Cherry	2600 x 1800	K04-FORMATKA-WIEL-GR_36-KOR01
	Portofino Cherry	2600 x 1800	K04-FORMATKA-WISP-GR_36-KOR01

* dimensions are given in mm

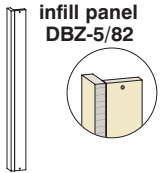

infill panel DBZ-5/82

For lengthening lower cabinet side finishing assembly, carcass depth of which is 508 mm.
material: filler panel # 16 mm,
packing: 1 item

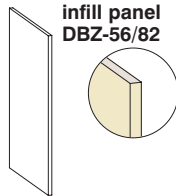

infill panel DBZ-56/82

For lengthening lower cabinet side finishing assembly, carcass depth of which is 508 mm.
material: filler panel # 16 mm,
packing: 1 item
Please note: on this blender the routing is to the back of the cabinet; holes should be drilled before mounting (the side referred to may serve as a pattern).

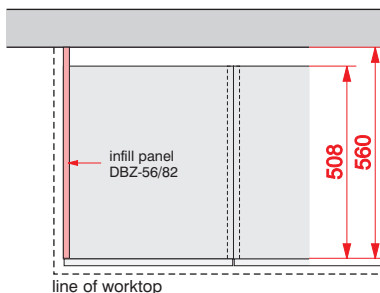
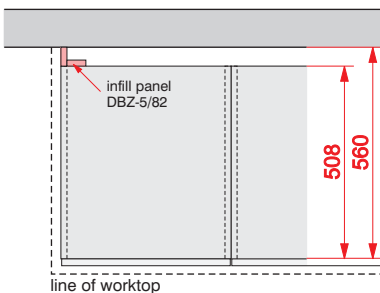

principles for ordering filler panels in carcass colours and illuminated panel

ordering filler panels in carcass colours

- 1) all dimensions should be given in millimetres;
- 2) minimal width of filler panel # 36 mm = 200 mm, minimum surface = 0.1 m²;
- 3) mark the edge which will be finished with a PVC rim (filler panels # 16 mm - PVC 0.6 mm, filler panels # 36 mm - PVC 3 mm);
- 4) finish of PVC rim should happen on arch (recommended distance from arch min. 50 mm);
- 5) edges at an angle of 90° with PVC rim may be finished "sharply", and in the remaining cases a minimum radius should be applied (for filler panels # 36 mm r_{min} ext. = 60 mm, r_{min} int. = 150 mm);
- 6) ordering filler panels with wood-effect laminate it is necessary to give dimensions of particular panels (sketch 1, the first given dimensions runs lengthways on wood grain) or mark wood grain direction on sketch (sketch 2); in the event of lack of designation wood grain shall run along the long side of filler panel (sketch 3)

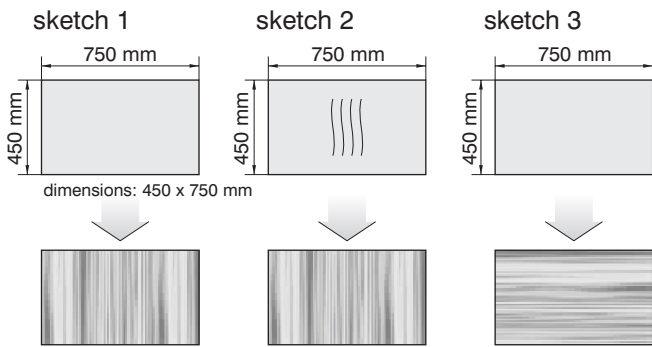

ordering lighting panel

- 7) all panels forming the lighting panel should be presented on one sketch, in the way that they will be mounted at the client's kitchen;
- 8) the external dimensions of the panel should be given and also the dimensions of particular component panels (dimensions in mm);
- 9) the finishing of the panel on external corner units should be appropriately described for the given cabinet types;
- 10) min. panel width for particular types:
type PR1 min. width = 300 mm,
type PS1 min. width = 300 mm,
type PU1 min. width = 368 mm*, 425 mm**,
type PU2 min. width = 300 mm*, 325 mm**
 * filler panels # 16 mm with PVC rim 0.6 mm,
 ** filler panels # 36 mm with PVC rim 3 mm;
- 11) length of side of lighting panel over type GNWU cabinet is calculated according to the example given on the bottom of the page.

calculation of length of side of lighting panel over GNWU type cabinet

$$x = a \times 0.414 + b$$

a - projection of panel in door of upper cabinet

b - width of GNWU cabinet

0.414 - fixed size

example: calculation of lighting panel side of width 450 mm

$$x = 150 \times 0.414 + 600 = 662.1 = 662 \text{ mm}$$

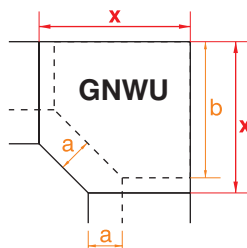

types of finish of lighting panel

GNZR

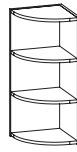

TNZR

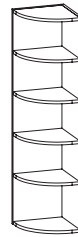

TYPE PR1

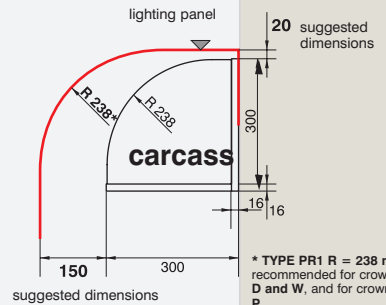

* TYPE PR1 R = 238 mm recommended for crown strip D and W, and for crown strip P

GNZRF

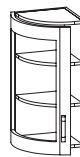

TNZRF



TYPE PR1

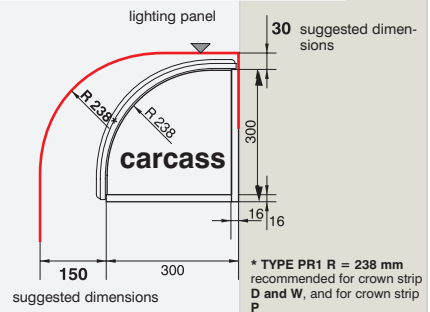

* TYPE PR1 R = 238 mm recommended for crown strip D and W, and for crown strip P

GNZ

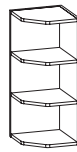

TNZ

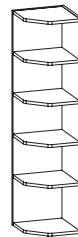

TYPE PS1

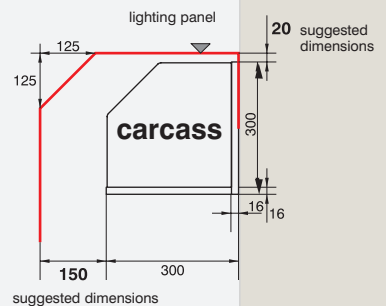

GNZUF

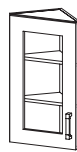

TYPE PU1

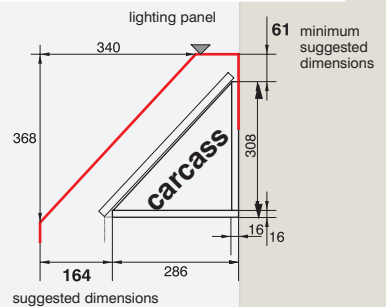

GNZU2F

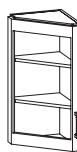

TNZU2F

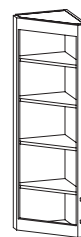

TYPE PU2

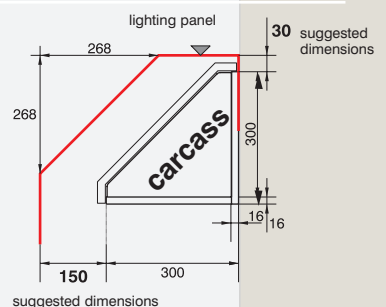

example order for filler panels in carcass colours and lighting panel

sketch 1	format	sketch 2	format	sketch 3	lighting panel
colour:	Wenge	colour:	Light Chestnut	colour:	San Alder
thickness:	# 36 mm	thickness:	# 16 mm	thickness:	# 16 mm
edge:	PVC	edge:	do not glue	edge:	PVC
joining:	---	joining:	---	joining:	straight

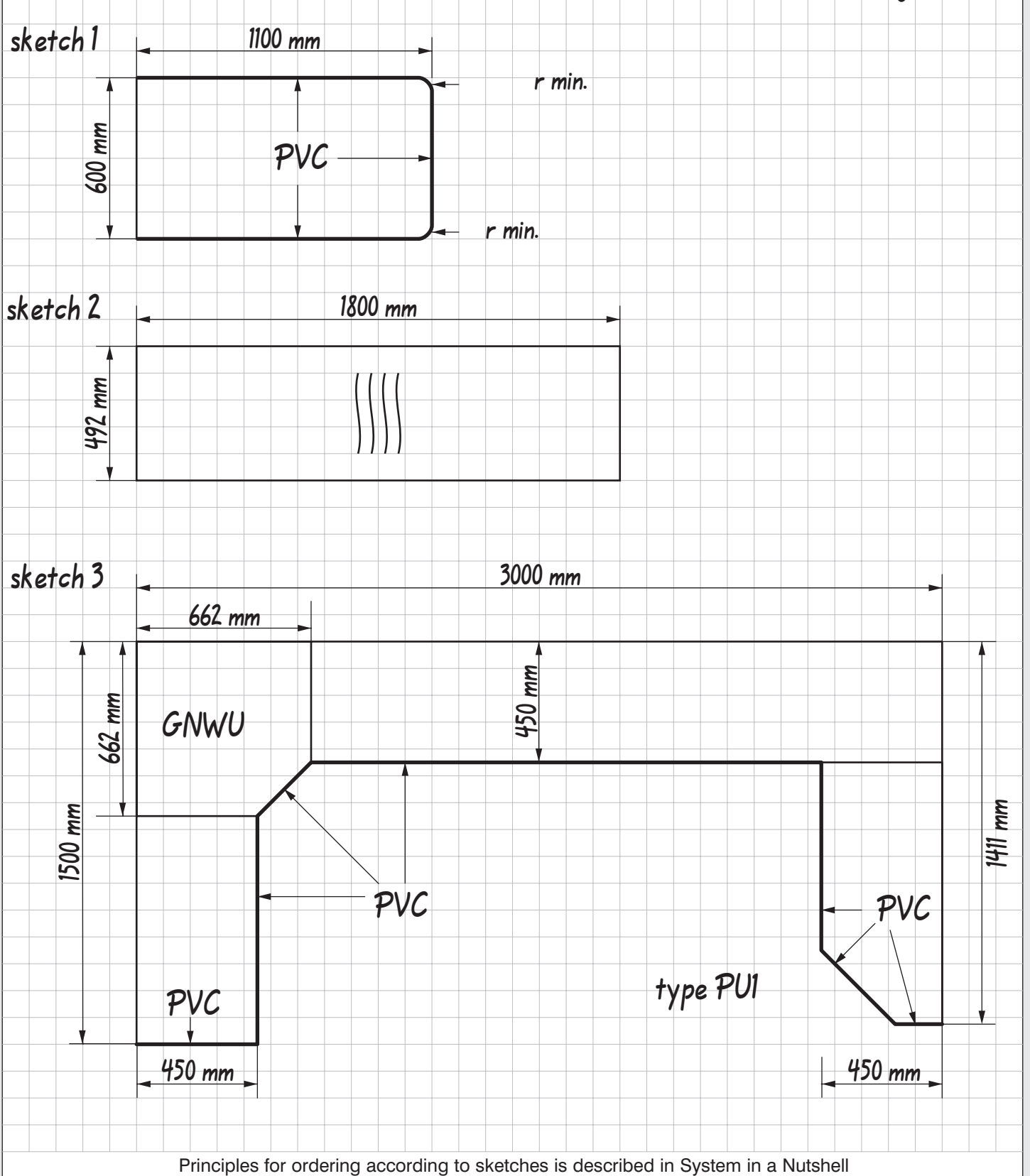

Principles for ordering according to sketches is described in System in a Nutshell

worktop colours



Sanenberg Beech (BUS)

rim: melamine, PVC
countertop strip in worktop colour: type I

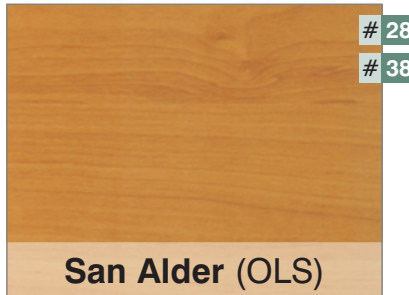

San Alder (OLS)

rim: melamine, PVC
worktop strip in worktop colour: type I

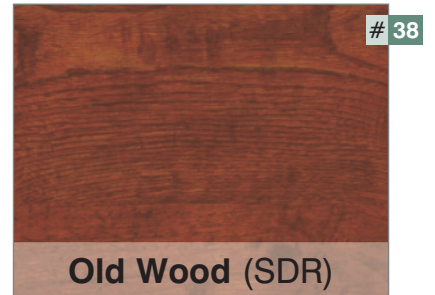

Old Wood (SDR)

rim: melamine, PVC
worktop strip in worktop colour: type I, type II

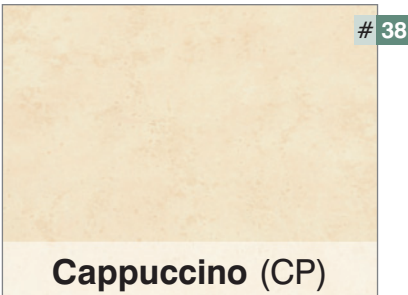

Cappuccino (CP)

rim: melamine, PVC
worktop strip in worktop colour: type I, type II



Beige Pietra (PB)

rim: melamine, PVC
worktop strip in worktop colour: type I



Sandstone (PI)

rim: melamine, PVC
worktop strip in worktop colour: type I



Golden Granite (GRZ)

rim: melamine, PVC
worktop strip in worktop colour: type I, type II



Royal Granite (GRR)

rim: melamine, PVC
worktop strip in worktop colour: type I



Brick (CE)

rim: melamine, PVC
worktop strip in worktop colour: type I

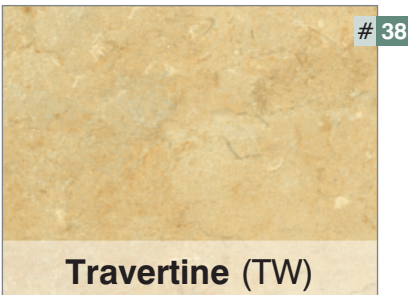

Travertine (TW)

rim: melamine, PVC
worktop strip in worktop colour: type I, type II



Malaga Green (MZ)

rim: melamine, PVC
worktop strip in worktop colour: type I

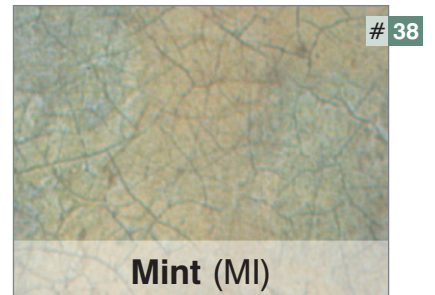

Mint (MI)

rim: melamine, PVC
worktop strip in worktop colour: type I



White (BI)

rim: melamine, PVC, SSV
worktop strip in worktop colour: type I, type II

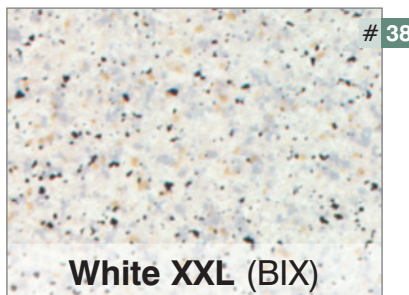

White XXL (BIX)

rim: melamine, PVC, SSV
worktop strip in worktop colour: type I

worktops panels and filler panels with curvature

product description	worktop panels with curvature		worktop filler panels with curvature	
	dimensions max. (length/width) *	index	dimensions max. (length/width) *	index
worktop White # 38 mm	4100 x 600	K04-BLAT-BI-DO_600_GR_38-BLA01	4100 x 1200	K04-BLAT-BI-POW_600_GR_38-BLA01
worktop White XXL # 38 mm	4100 x 600	K04-BLAT-BIX-DO_600_GR_38-BLA01	4100 x 1200	K04-BLAT-BIX-POW_600_GR_38-BLA01
worktop Sanenberg Beech # 38 mm	4100 x 600	K04-BLAT-BUS-DO_600_GR_38-BLA01	4100 x 1200	K04-BLAT-BUS-POW_600_GR_38-BLA01
worktop Cappuccino # 38 mm	3000 x 600	K04-BLAT-CP-DO_600_GR_38-BLA01	3000 x 1200	K04-BLAT-CP-POW_600_GR_38-BLA01
worktop Brick # 38 mm	4100 x 600	K04-BLAT-CE-DO_600_GR_38-BLA01	4100 x 1200	K04-BLAT-CE-POW_600_GR_38-BLA01
worktop Royal Granite # 38 mm	4100 x 600	K04-BLAT-GRR-DO_600_GR_38-BLA01	4100 x 1200	K04-BLAT-GRR-POW_600_GR_38-BLA01
worktop Golden Granite # 38 mm	3600 x 600	K04-BLAT-GRZ-DO_600_GR_38-BLA01	3600 x 1200	K04-BLAT-GRZ-POW_600_GR_38-BLA01
worktop Malaga Green # 38 mm	2700 x 600	K04-BLAT-MZ-DO_600_GR_38-BLA01	2700 x 1200	K04-BLAT-MZ-POW_600_GR_38-BLA01
worktop Mint # 38 mm	4100 x 600	K04-BLAT-MI-DO_600_GR_38-BLA01	4100 x 1200	K04-BLAT-MI-POW_600_GR_38-BLA01
worktop San Alder # 28 mm	4100 x 600	K04-BLAT-OLS-DO_600_GR_28-BLA01		do not appear
worktop San Alder # 38 mm	4100 x 600	K04-BLAT-OLS-DO_600_GR_38-BLA01	4100 x 1200	K04-BLAT-OLS-POW_600_GR_38-BLA01
worktop Sandstone # 38 mm	4100 x 600	K04-BLAT-PI-DO_600_GR_38-BLA01	4100 x 1200	K04-BLAT-PI-POW_600_GR_38-BLA01
worktop Beige Pietra # 28 mm	4100 x 600	K04-BLAT-PB-DO_600_GR_28-BLA01		do not appear
worktop Beige Pietra # 38 mm	4100 x 600	K04-BLAT-PB-DO_600_GR_38-BLA01	4100 x 1200	K04-BLAT-PB-POW_600_GR_38-BLA01
worktop Old Wood # 38 mm	4100 x 600	K04-BLAT-SDR-DO_600_GR_38-BLA01	4100 x 1200	K04-BLAT-SDR-POW_600_GR_38-BLA01
worktop Travertine # 38 mm	3600 x 600	K04-BLAT-TW-DO_600_GR_38-BLA01	3600 x 1200	K04-BLAT-TW-POW_600_GR_38-BLA01

* dimensions are given in mm

panel / filler panel with curvature

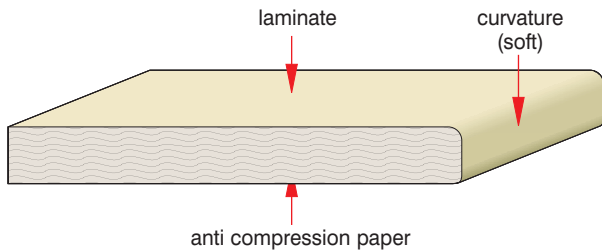

Worktops made from panels / filler panels are standard finished with laminate, which is wrapped around curvature. From the bottom panel is protected with anti compression paper.

panel / filler panel with curvature

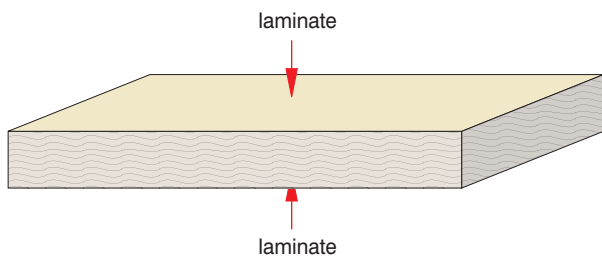

Double sided laminated filler panel offered in colours White and White XXL is not available with curvature. Worktops ages made with these filler panels should be finished with a rim (melamine, PVC or SSV).

available rim colours

	melamine	PVC	SSV	
	# 0,35 mm	# 3 mm	# 3 mm	
White (BI)	X	X	X	
White XXL (BIX)	X	X	X	
Sanenberg Beech (BUS)	X	X		
Cappuccino (CP)	X	X		
Brick (CE)	X	X		
Royal Granite (GRR)	X	X		
Golden Granite (GRZ)	X	X		
Malaga Green (MZ)	X	X		
Mint (MI)	X	X		
San Alder (OLS)	X	X		
Sandstone (PI)	X	X		
Beige Pietra (PB)	X	X		
Old Wood (SDR)	X	X		
Travertine (TW)	X	X		
Silver (SRE)		X		

PVC # 3 mm rims in carcass colours may also be glued to countertop panels and plinths

Beige (BE), White (BI), Milan Oak (DMI), Windsor Oak (DW), Chestnut (KA), Medium Chestnut (KAS), Maple Nida (KLN), Wenge (WE), Elba Cherry (WISE), Electra Cherry (WIEL), Portofino Cherry (WISP), Grey (SZ)

worktop panels and plinths with lead edges with glued PVC rim

product description	worktop panels with PVC rim		worktop filler panels with PVC rim	
	dimensions max. (length/width) *	index	dimensions max. (length/width) *	index
worktop White # 38 mm	4100 x 600	K04-BLAT-BI-PVC_DO_600_GR_38-BLA01	4100 x 1200	K04-BLAT-BI-PVC_POW_600_GR_38-BLA01
worktop White XXL # 38 mm	4100 x 600	K04-BLAT-BIX-PVC_DO_600_GR_38-BLA01	4100 x 1200	K04-BLAT-BIX-PVC_POW_600_GR_38-BLA01
worktop Sanenberg Beech # 38 mm	4100 x 600	K04-BLAT-BUS-PVC_DO_600_GR_38-BLA01	4100 x 1200	K04-BLAT-BUS-PVC_POW_600_GR_38-BLA01
worktop Cappuccino # 38 mm	3000 x 600	K04-BLAT-CP-PVC_DO_600_GR_38-BLA01	3000 x 1200	K04-BLAT-CP-PVC_POW_600_GR_38-BLA01
worktop Brick # 38 mm	4100 x 600	K04-BLAT-CE-PVC_DO_600_GR_38-BLA01	4100 x 1200	K04-BLAT-CE-PVC_POW_600_GR_38-BLA01
worktop Royal Granite # 38 mm	4100 x 600	K04-BLAT-GRR-PVC_DO_600_GR_38-BLA01	4100 x 1200	K04-BLAT-GRR-PVC_POW_600_GR_38-BLA01
worktop Golden Granite # 38 mm	3600 x 600	K04-BLAT-GRZ-PVC_DO_600_GR_38-BLA01	3600 x 1200	K04-BLAT-GRZ-PVC_POW_600_GR_38-BLA01
worktop Malaga Green # 38 mm	2700 x 600	K04-BLAT-MZ-PVC_DO_600_GR_38-BLA01	2700 x 1200	K04-BLAT-MZ-PVC_POW_600_GR_38-BLA01
worktop Mint # 38 mm	4100 x 600	K04-BLAT-MI-PVC_DO_600_GR_38-BLA01	4100 x 1200	K04-BLAT-MI-PVC_POW_600_GR_38-BLA01
worktop San Alder # 28 mm	4100 x 600	K04-BLAT-OLS-PVC_DO_600_GR_28-BLA01	do not appear	
worktop San Alder # 38 mm	4100 x 600	K04-BLAT-OLS-PVC_DO_600_GR_38-BLA01	4100 x 1200	K04-BLAT-OLS-PVC_POW_600_GR_38-BLA01
worktop Sandstone # 38 mm	4100 x 600	K04-BLAT-PI-PVC_DO_600_GR_38-BLA01	4100 x 1200	K04-BLAT-PI-PVC_POW_600_GR_38-BLA01
worktop Beige Pietra # 28 mm	4100 x 600	K04-BLAT-PB-PVC_DO_600_GR_28-BLA01	do not appear	
worktop Beige Pietra # 38 mm	4100 x 600	K04-BLAT-PB-PVC_DO_600_GR_38-BLA01	4100 x 1200	K04-BLAT-PB-PVC_POW_600_GR_38-BLA01
worktop Old Wood # 38 mm	4100 x 600	K04-BLAT-SDR-PVC_DO_600_GR_38-BLA01	4100 x 1200	K04-BLAT-SDR-PVC_POW_600_GR_38-BLA01
worktop Travertine # 38 mm	3600 x 600	K04-BLAT-TW-PVC_DO_600_GR_38-BLA01	3600 x 1200	K04-BLAT-TW-PVC_POW_600_GR_38-BLA01

* dimensions are given in mm

worktop panels and plinths with glued SSV rim

product description	worktop panels with SSV rim		worktop filler panels with SSV rim	
	dimensions max. (length/width) *	index	dimensions max. (length/width) *	index
worktop White # 38 mm	4100 x 600	K04-BLAT-BI-SSV_DO_600_GR_38-BLA01	4100 x 1200	K04-BLAT-BI-SSV_POW_600_GR_38-BLA01
worktop White XXL # 38 mm	4100 x 600	K04-BLAT-BIX-SSV_DO_600_GR_38-BLA01	4100 x 1200	K04-BLAT-BIX-SSV_POW_600_GR_38-BLA01

* dimensions are given in mm

double sided laminated worktop filler panels

product description	dimensions max. (length/width) *	with PVC rim	with SSV rim
		index	index
filler panel White # 38 mm	4100 x 1200	K04-FORMATKA-BI-PVC_GR_38-BLA01	K04-FORMATKA-BI-SSV_GR_38-BLA01
filler panel White XXL # 38 mm	4100 x 1200	K04-FORMATKA-BIX-PVC_GR_38-BLA01	K04-FORMATKA-BIX-SSV_GR_38-BLA01

* dimensions are given in mm

finishing worktop edges



melamine

thickness: 0.3-0.4 mm (depending on colour)
availability: in worktop colours
application: worktop panels and filler panels

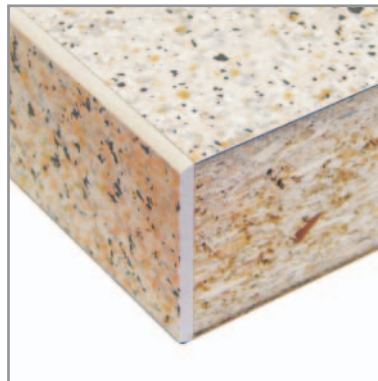

PVC rims

thickness: 3 mm
availability: in worktop and carcass + silver colours
application: countertop's and countertop filler panels, filler panels # 36 mm in carcass colours



SSV rims

thickness: 3 mm
availability: colours White and White XXL
application: worktop panels and filler panels

DNWU worktops

product description	fills corner *	DNWU worktop with curvature		DNWU worktop with PVC rim	
		index	index	index	index
DNWU worktop White # 38 mm	900 x 900	K04-BLAT-BI-BL_DNWU_90_GR_38-BLA01	K04-BLAT-BI-PVC_BL_DNWU_90_GR_38-BLA01	K04-BLAT-BI-BL_DNWU_105_GR_38-BLA01	K04-BLAT-BI-PVC_BL_DNWU_105_GR_38-BLA01
	1050 x 1050	K04-BLAT-BI-BL_DNWU_105_GR_38-BLA01	K04-BLAT-BI-PVC_BL_DNWU_105_GR_38-BLA01		
DNWU worktop White XXL # 38 mm	900 x 900	K04-BLAT-BIX-BL_DNWU_90_GR_38-BLA01	K04-BLAT-BIX-PVC_BL_DNWU_90_GR_38-BLA01	K04-BLAT-BIX-BL_DNWU_105_GR_38-BLA01	K04-BLAT-BIX-PVC_BL_DNWU_105_GR_38-BLA01
	1050 x 1050	K04-BLAT-BIX-BL_DNWU_105_GR_38-BLA01	K04-BLAT-BIX-PVC_BL_DNWU_105_GR_38-BLA01		
DNWU worktop Sanenberg Beech # 38 mm	900 x 900	K04-BLAT-BUS-BL_DNWU_90_GR_38-BLA01	K04-BLAT-BUS-PVC_BL_DNWU_90_GR_38-BLA01	K04-BLAT-BUS-BL_DNWU_105_GR_38-BLA01	K04-BLAT-BUS-PVC_BL_DNWU_105_GR_38-BLA01
	1050 x 1050	K04-BLAT-BUS-BL_DNWU_105_GR_38-BLA01	K04-BLAT-BUS-PVC_BL_DNWU_105_GR_38-BLA01		
DNWU worktop Cappuccino # 38 mm	900 x 900	K04-BLAT-CP-BL_DNWU_90_GR_38-BLA01	K04-BLAT-CP-PVC_BL_DNWU_90_GR_38-BLA01	K04-BLAT-CP-BL_DNWU_105_GR_38-BLA01	K04-BLAT-CP-PVC_BL_DNWU_105_GR_38-BLA01
	1050 x 1050	K04-BLAT-CP-BL_DNWU_105_GR_38-BLA01	K04-BLAT-CP-PVC_BL_DNWU_105_GR_38-BLA01		
DNWU worktop Brick # 38 mm	900 x 900	K04-BLAT-CE-BL_DNWU_90_GR_38-BLA01	K04-BLAT-CE-PVC_BL_DNWU_90_GR_38-BLA01	K04-BLAT-CE-BL_DNWU_105_GR_38-BLA01	K04-BLAT-CE-PVC_BL_DNWU_105_GR_38-BLA01
	1050 x 1050	K04-BLAT-CE-BL_DNWU_105_GR_38-BLA01	K04-BLAT-CE-PVC_BL_DNWU_105_GR_38-BLA01		
DNWU worktop Royal Granite # 38 mm	900 x 900	K04-BLAT-GRR-BL_DNWU_90_GR_38-BLA01	K04-BLAT-GRR-PVC_BL_DNWU_90_GR_38-BLA01	K04-BLAT-GRR-BL_DNWU_105_GR_38-BLA01	K04-BLAT-GRR-PVC_BL_DNWU_105_GR_38-BLA01
	1050 x 1050	K04-BLAT-GRR-BL_DNWU_105_GR_38-BLA01	K04-BLAT-GRR-PVC_BL_DNWU_105_GR_38-BLA01		
DNWU worktop Golden Granite # 38 mm	900 x 900	K04-BLAT-GRZ-BL_DNWU_90_GR_38-BLA01	K04-BLAT-GRZ-PVC_BL_DNWU_90_GR_38-BLA01	K04-BLAT-GRZ-BL_DNWU_105_GR_38-BLA01	K04-BLAT-GRZ-PVC_BL_DNWU_105_GR_38-BLA01
	1050 x 1050	K04-BLAT-GRZ-BL_DNWU_105_GR_38-BLA01	K04-BLAT-GRZ-PVC_BL_DNWU_105_GR_38-BLA01		
DNWU worktop Malaga Green # 38 mm	900 x 900	K04-BLAT-MZ-BL_DNWU_90_GR_38-BLA01	K04-BLAT-MZ-PVC_BL_DNWU_90_GR_38-BLA01	K04-BLAT-MZ-BL_DNWU_105_GR_38-BLA01	K04-BLAT-MZ-PVC_BL_DNWU_105_GR_38-BLA01
	1050 x 1050	K04-BLAT-MZ-BL_DNWU_105_GR_38-BLA01	K04-BLAT-MZ-PVC_BL_DNWU_105_GR_38-BLA01		
DNWU worktop Mint # 38 mm	900 x 900	K04-BLAT-MI-BL_DNWU_90_GR_38-BLA01	K04-BLAT-MI-PVC_BL_DNWU_90_GR_38-BLA01	K04-BLAT-MI-BL_DNWU_105_GR_38-BLA01	K04-BLAT-MI-PVC_BL_DNWU_105_GR_38-BLA01
	1050 x 1050	K04-BLAT-MI-BL_DNWU_105_GR_38-BLA01	K04-BLAT-MI-PVC_BL_DNWU_105_GR_38-BLA01		
DNWU worktop San Alder # 38 mm	900 x 900	K04-BLAT-OLS-BL_DNWU_90_GR_38-BLA01	K04-BLAT-OLS-PVC_BL_DNWU_90_GR_38-BLA01	K04-BLAT-OLS-BL_DNWU_105_GR_38-BLA01	K04-BLAT-OLS-PVC_BL_DNWU_105_GR_38-BLA01
	1050 x 1050	K04-BLAT-OLS-BL_DNWU_105_GR_38-BLA01	K04-BLAT-OLS-PVC_BL_DNWU_105_GR_38-BLA01		
DNWU worktop Sandstone # 38 mm	900 x 900	K04-BLAT-PI-BL_DNWU_90_GR_38-BLA01	K04-BLAT-PI-PVC_BL_DNWU_90_GR_38-BLA01	K04-BLAT-PI-BL_DNWU_105_GR_38-BLA01	K04-BLAT-PI-PVC_BL_DNWU_105_GR_38-BLA01
	1050 x 1050	K04-BLAT-PI-BL_DNWU_105_GR_38-BLA01	K04-BLAT-PI-PVC_BL_DNWU_105_GR_38-BLA01		
DNWU worktop Beige Pietra # 38 mm	900 x 900	K04-BLAT-PB-BL_DNWU_90_GR_38-BLA01	K04-BLAT-PB-PVC_BL_DNWU_90_GR_38-BLA01	K04-BLAT-PB-BL_DNWU_105_GR_38-BLA01	K04-BLAT-PB-PVC_BL_DNWU_105_GR_38-BLA01
	1050 x 1050	K04-BLAT-PB-BL_DNWU_105_GR_38-BLA01	K04-BLAT-PB-PVC_BL_DNWU_105_GR_38-BLA01		
DNWU worktop Old Wood # 38 mm	900 x 900	K04-BLAT-SDR-BL_DNWU_90_GR_38-BLA01	K04-BLAT-SDR-PVC_BL_DNWU_90_GR_38-BLA01	K04-BLAT-SDR-BL_DNWU_105_GR_38-BLA01	K04-BLAT-SDR-PVC_BL_DNWU_105_GR_38-BLA01
	1050 x 1050	K04-BLAT-SDR-BL_DNWU_105_GR_38-BLA01	K04-BLAT-SDR-PVC_BL_DNWU_105_GR_38-BLA01		
DNWU worktop Travertine # 38 mm	900 x 900	K04-BLAT-TW-BL_DNWU_90_GR_38-BLA01	K04-BLAT-TW-PVC_BL_DNWU_90_GR_38-BLA01	K04-BLAT-TW-BL_DNWU_105_GR_38-BLA01	K04-BLAT-TW-PVC_BL_DNWU_105_GR_38-BLA01
	1050 x 1050	K04-BLAT-TW-BL_DNWU_105_GR_38-BLA01	K04-BLAT-TW-PVC_BL_DNWU_105_GR_38-BLA01		

* dimensions are given in mm

ATTENTION: in the case of worktop with SSV rim - SSV_ is added to indexes:

K04-BLAT-BI-SSV_BL_DNWU_90_GR_38, K04-BLAT-BIX-SSV_BL_DNWU_90_GR_38

application of DNWU worktops

worktops **DNWU 90**

1) DNWU-90/82 type corner units (sketch 1)

2) DNWUST/4-90/82 and DNWUST/5-90/82 type cabinets with application of infill panel DNWU45-4/82 (sketch 2)

3) lower cabinets of dimensions 45/82 cm (width/height) with application of infill panel DNWU45-4/82 (sketch 3)

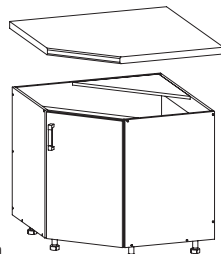

sketch 1) DNWU 90 worktop over cabinet DNWU-90/82-P

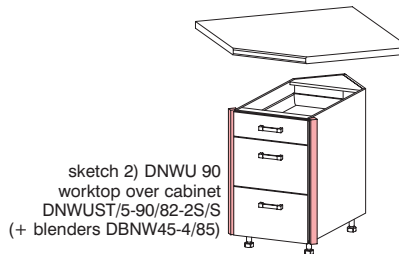

sketch 2) DNWU 90 worktop over cabinet DNWUST/5-90/82-2S/S (+ blenders DBNW45-4/85)

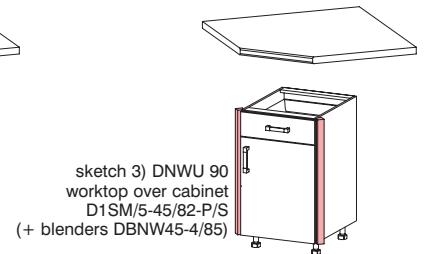

sketch 3) DNWU 90 worktop over cabinet D1SM/5-45/82-P/S (+ blenders DBNW45-4/85)

countertops **DNWU 105**

lower cabinets of dimensions 60/82 cm (width/height) with application of infill panel DNWU60-5/82 (sketch 4-5)

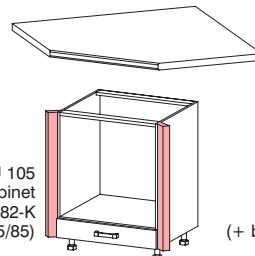

sketch 4) DNWU 105 worktop over cabinet DP-60/82-K (+ blenders DBNW60-5/85)

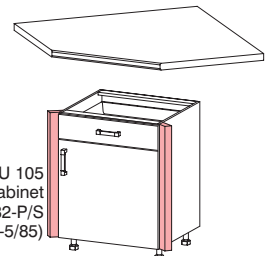

sketch 5) DNWU 105 worktop over cabinet D1SM/5-60/82-P/S (+ blenders DBNW60-5/85)

infill panel DBWN45-4/82 and DBNW60-5/82 described on p. 62



principles for ordering worktops according to sketches

general principles

- 1) all panels composing worktops shall be presented in one sketch, in the arrangement that will be fitted at the client's kitchen;
- 2) write external dimensions of worktop and dimensions of individual panels (width and depth);
- 3) all dimensions should be given in millimetres;
- 4) on the sketch show method of joining panels (cutting and filling, angle strip, straight strip);
- 5) in the case of joining panels without strips they should be joined by screws (for all wide panels the standard is 3 connections 150 mm for each);
- 6) at the point of attachment panel edges should be finished in same way;
- 7) mark the manner of finishing panel edges (curvature, melamine, PVC, SSV);
- 8) finishing panels on external corner units should be described appropriately for each cabinet type;
- 9) panel on DNWU cabinet should also be described as a type;
- 10) min. recommended distance of panel joint from heater panels, sinks, dishwashers etc is 100 mm.
- 11) according to sketch, only panels are ordered, remaining elements (screw joints, panel joining strips, panel thickening strips etc) are ordered separately;

ordering worktops with PVC / SSV rims

- 12) min. width = 200 mm, minimum surface = 0.1 m²;
 exceptions: **type BR1** 12. min. width = 300 mm; **type BS1** min. width = 300 mm,
type BU1 12. min. width = 350 mm**, 400 mm*,
type BU2 12. min. width = 300 mm**, 350 mm*
 * countertops with lead edges with PVC or SSV rim,
 ** countertops with lead edges with curvature;
- 13) type BR1 worktops with curvature may not be finished with PVC rim;
- 14) PVC/SSV finishing rim should not be on an bow (recommended distance from bow min. 50 mm);
- 15) with edges at 90° angle a PVC/SSV rim may be finished sharply, in remaining cases minimum radius shall be applied.

min. radius for worktops with PVC/SSV rim

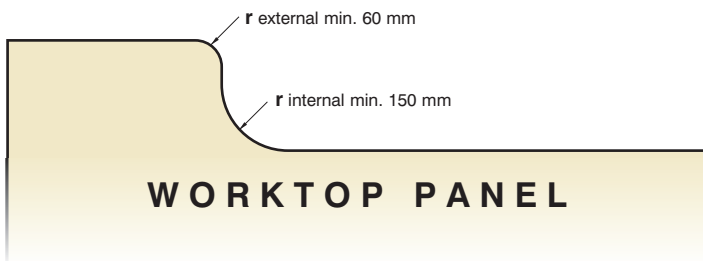

Symbols applied when ordering worktops according to sketches

- screw joint 150 mm (65 mm join should be additionally described)
- direction of grain (if unspecified lengthways with longest side)
- r min.** minimum radius
- non-glued edge

types of countertop finishes

DNZR	TYPE BR1	
DNZRF	TYPE BR1	
DNZ	TYPE BS1	
DNZUF	TYPE BU1	
DNZU2F	TYPE BU2	

example worktop order according to sketch



sketch 1	worktop	sketch 2	worktops	sketch 3	
colour:	Golden Granite	colour:	Sanenberg Beech	colour:	
thickness:	# 38 mm	thickness:	# 38 mm	thickness:	
edge:	melamine	edge:	PVC	edge:	
joining:	angle strip	joining:	bending screws "50"	joining:	

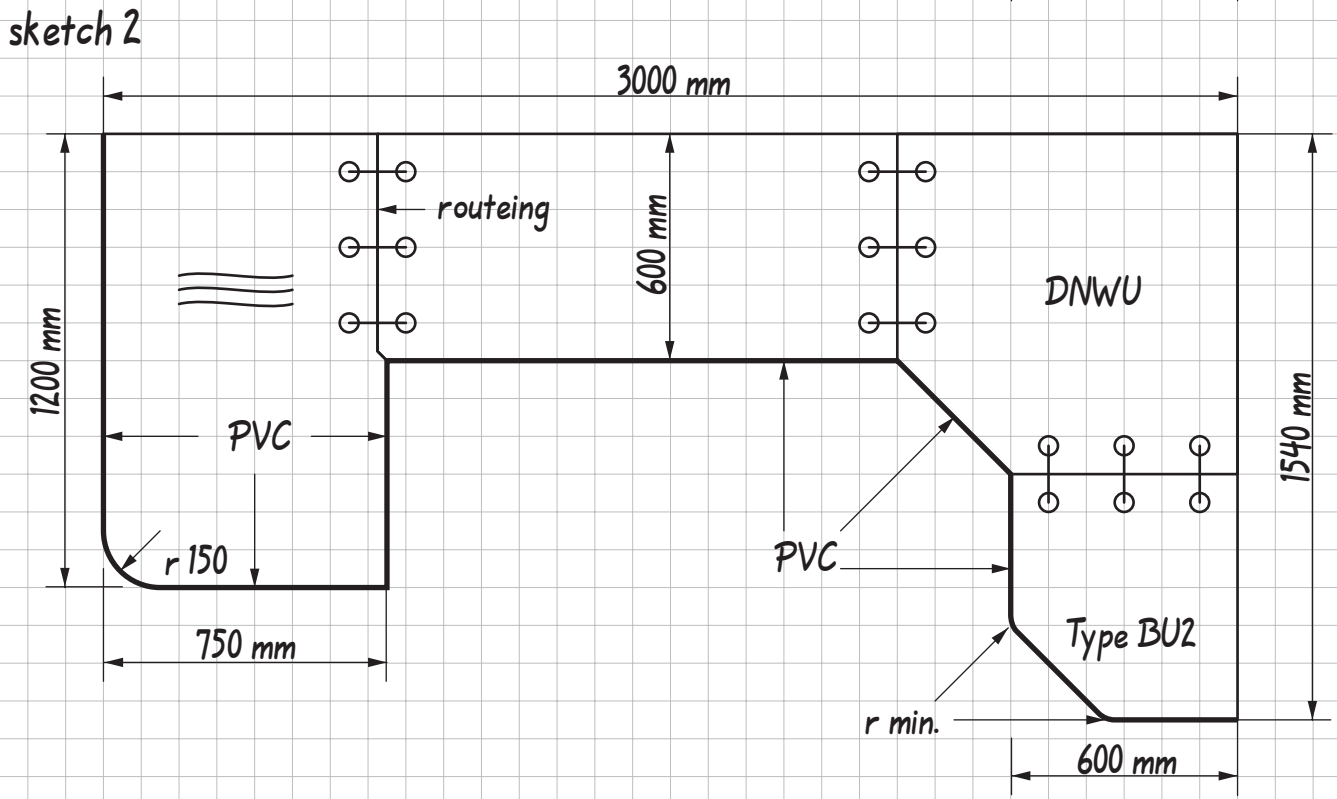
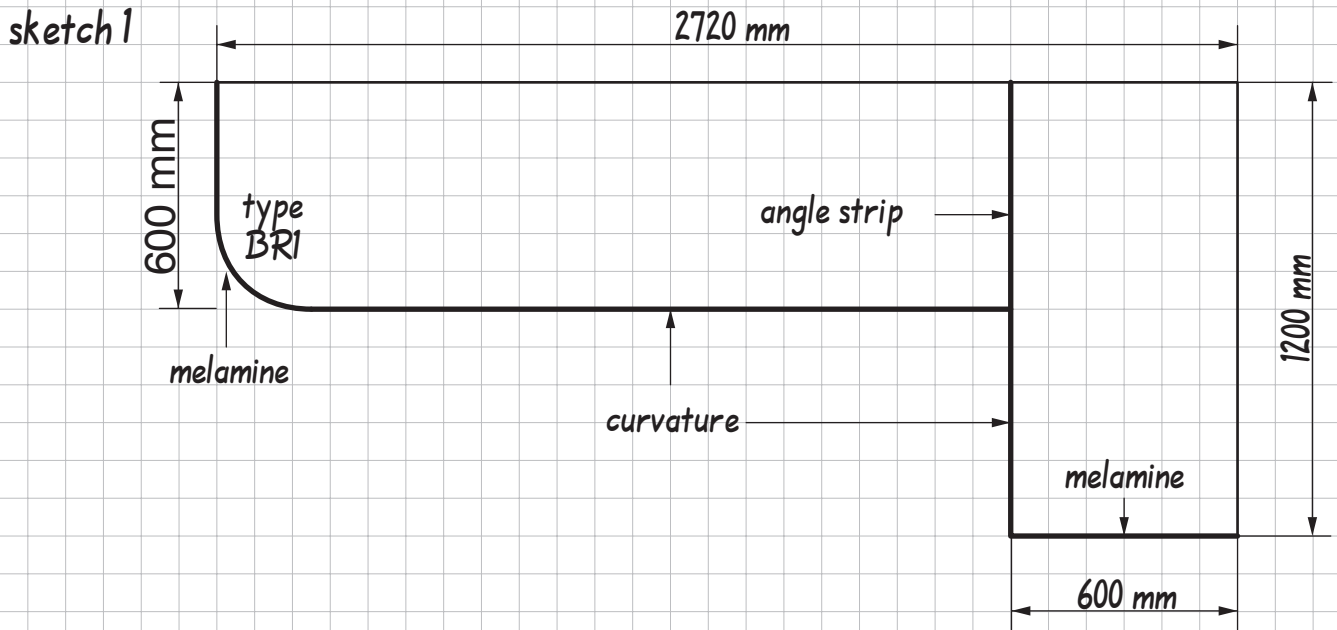

Principles for ordering according to sketches is described in System in a Nutshell

worktop strip in worktop colours **type I**



description	colour / colour of endings and corner units	available lengths*	index
worktop strip in worktop colours, type I 	White - aluminium	2500, 5000	SK-BI-LIS-PRZYBLATOWA_117
	White XXL - white	2500, 5000	SK-BIX-LIS-PRZYBLATOWA_117
	Sanenberg Beech beech	2500, 5000	SK-BS-LIS-PRZYBLATOWA_117
	Cappuccino - beige	2500, 5000	SK-CP-LIS-PRZYBLATOWA_117
	Brick - brick	2500, 5000	SK-CE-LIS-PRZYBLATOWA_117
	Royal Granite - ash	2500, 5000	SK-GRR-LIS-PRZYBLATOWA_117
	Golden Granite - light oak	2500, 5000	SK-GRZ-LIS-PRZYBLATOWA_117
	Mint - granite	2500, 5000	SK-MI-LIS-PRZYBLATOWA_117
	Malaga Green - green	2500, 5000	SK-MZ-LIS-PRZYBLATOWA_117
	San Alder - beech	2500, 5000	SK-OLS-LIS-PRZYBLATOWA_117
	Sandstone - beige	2500, 5000	SK-PI-LIS-PRZYBLATOWA_117
	Beige Pietra - beige	2500, 5000	SK-PB-LIS-PRZYBLATOWA_117
	Old Wood - bronze	2500, 5000	SK-SDR-LIS-PRZYBLATOWA_117
	Travertine - beige	2500, 5000	SK-TW-LIS-PRZYBLATOWA_117

* dimensions are given in mm

product description	colour	internal corner unit 90°		internal corner unit 135°	
		index	index	index	index
internal corner for worktop strips in worktop colours type I 	aluminium	SK-AL-NAROZNIK_WEW_90	SK-AL-NAROZNIK_WEW_135	SK-AL-NAROZNIK_WEW_90	SK-AL-NAROZNIK_WEW_135
	beige	SK-BE-NAROZNIK_WEW_90	SK-BE-NAROZNIK_WEW_135	SK-BE-NAROZNIK_WEW_90	SK-BE-NAROZNIK_WEW_135
	white	SK-BI-NAROZNIK_WEW_90	SK-BI-NAROZNIK_WEW_135	SK-BI-NAROZNIK_WEW_90	SK-BI-NAROZNIK_WEW_135
	bronze	SK-BR-NAROZNIK_WEW_90	SK-BR-NAROZNIK_WEW_135	SK-BR-NAROZNIK_WEW_90	SK-BR-NAROZNIK_WEW_135
	beech	SK-BU-NAROZNIK_WEW_90	SK-BU-NAROZNIK_WEW_135	SK-BU-NAROZNIK_WEW_90	SK-BU-NAROZNIK_WEW_135
	brick	SK-CE-NAROZNIK_WEW_90	SK-CE-NAROZNIK_WEW_135	SK-CE-NAROZNIK_WEW_90	SK-CE-NAROZNIK_WEW_135
	light oak	SK-DJ-NAROZNIK_WEW_90	SK-DJ-NAROZNIK_WEW_135	SK-DJ-NAROZNIK_WEW_90	SK-DJ-NAROZNIK_WEW_135
	granite	SK-GR-NAROZNIK_WEW_90	SK-GR-NAROZNIK_WEW_135	SK-GR-NAROZNIK_WEW_90	SK-GR-NAROZNIK_WEW_135
	ash	SK-PP-NAROZNIK_WEW_90	SK-PP-NAROZNIK_WEW_135	SK-PP-NAROZNIK_WEW_90	SK-PP-NAROZNIK_WEW_135
	green	SK-ZI-NAROZNIK_WEW_90	SK-ZI-NAROZNIK_WEW_135	SK-ZI-NAROZNIK_WEW_90	SK-ZI-NAROZNIK_WEW_135

product description	colour	index
external corner 90° for worktop strips in worktop colours type I 	aluminium	SK-AL-NAROZNIK_ZEW_90
	beige	SK-BE-NAROZNIK_ZEW_90
	white	SK-BI-NAROZNIK_ZEW_90
	bronze	SK-BR-NAROZNIK_ZEW_90
	beech	SK-BU-NAROZNIK_ZEW_90
	brick	SK-CE-NAROZNIK_ZEW_90
	light oak	SK-DJ-NAROZNIK_ZEW_90
	granite	SK-GR-NAROZNIK_ZEW_90
	ash	SK-PP-NAROZNIK_ZEW_90
	green	SK-ZI-NAROZNIK_ZEW_90

product description	colour	end left		end right	
		index	index	index	index
ends to worktop strips in worktop colours type I 	aluminium	SK-AL-KONCOWKA_LEWA	SK-AL-KONCOWKA_PRAWA	SK-AL-KONCOWKA_LEWA	SK-AL-KONCOWKA_PRAWA
	beige	SK-BE-KONCOWKA_LEWA	SK-BE-KONCOWKA_PRAWA	SK-BE-KONCOWKA_LEWA	SK-BE-KONCOWKA_PRAWA
	white	SK-BI-KONCOWKA_LEWA	SK-BI-KONCOWKA_PRAWA	SK-BI-KONCOWKA_LEWA	SK-BI-KONCOWKA_PRAWA
	bronze	SK-BR-KONCOWKA_LEWA	SK-BR-KONCOWKA_PRAWA	SK-BR-KONCOWKA_LEWA	SK-BR-KONCOWKA_PRAWA
	beech	SK-BU-KONCOWKA_LEWA	SK-BU-KONCOWKA_PRAWA	SK-BU-KONCOWKA_LEWA	SK-BU-KONCOWKA_PRAWA
	brick	SK-CE-KONCOWKA_LEWA	SK-CE-KONCOWKA_PRAWA	SK-CE-KONCOWKA_LEWA	SK-CE-KONCOWKA_PRAWA
	light oak	SK-DJ-KONCOWKA_LEWA	SK-DJ-KONCOWKA_PRAWA	SK-DJ-KONCOWKA_LEWA	SK-DJ-KONCOWKA_PRAWA
	granite	SK-GR-KONCOWKA_LEWA	SK-GR-KONCOWKA_PRAWA	SK-GR-KONCOWKA_LEWA	SK-GR-KONCOWKA_PRAWA
	ash	SK-PP-KONCOWKA_LEWA	SK-PP-KONCOWKA_PRAWA	SK-PP-KONCOWKA_LEWA	SK-PP-KONCOWKA_PRAWA
	green	SK-ZI-KONCOWKA_LEWA	SK-ZI-KONCOWKA_PRAWA	SK-ZI-KONCOWKA_LEWA	SK-ZI-KONCOWKA_PRAWA

splash-back batten in worktop colours **type II**

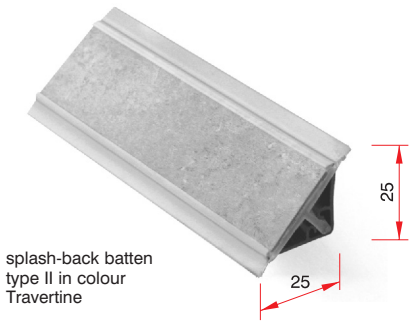

splash-back batten type II in colour Travertine

Splash-back battens type II in colours Cappuccino, Golden Granite, Old Wood and Travertine temporarily offered. It is intended that they will be replaced by type I worktops strips in above colours.

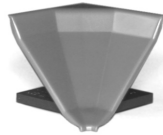

internal corner unit 90°



internal corner unit 135°

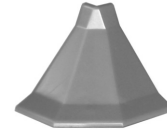

external corner unit 90°

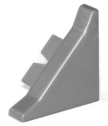

ending (universal)

description	colour / colour of endings and corner units	available lengths*	index
splash-back batten in worktop colours, type II	Cappuccino - ash	2500, 5000	SK-CP-LIS-PRZYBLATOWA_104
	Golden Granite - ash	2500, 5000	SK-GRZ-LIS-PRZYBLATOWA_104
	Old Wood - ash	2500, 5000	SK-SDR-LIS-PRZYBLATOWA_104
	Travertine - ash	2500, 5000	SK-TW-LIS-PRZYBLATOWA_104

* dimensions are given in mm

description	colour	index
internal corner 90° for splash-back battens in worktop colours type II	ash	SK-PP-NAROZNIK_104_WEW_90
internal corner 135° for splash-back battens in worktop colours type II	ash	SK-PP-NAROZNIK_104_WEW_135
external corner 90° for splash-back battens in worktop colours type II	ash	SK-PP-NAROZNIK_104_ZEW_90
ending (universal) for splash-back battens in worktop colours type II	ash	SK-PP-KONCOWKA_104

aluminium splash-back batten

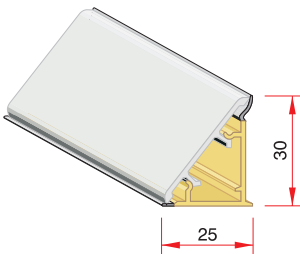

product description	available lengths*	index
aluminium splash-back batten	2000, 4000	SK-ALU-LIS-PRZYBLATOWA
internal corner 90°, left and right ends, colour grey set		SK-ALU-NW_90/KL/KP
external corner 90°, grey		SK-ALU-NZ_90

* dimensions are given in mm

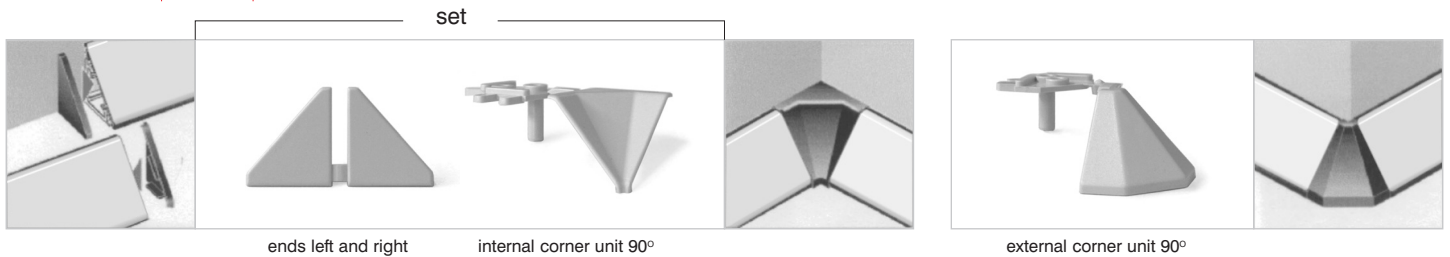

ends left and right

internal corner unit 90°

external corner unit 90°

mounting splash-back battens

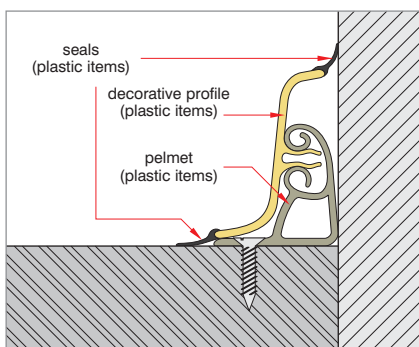

method of mounting splash-back batten in worktop colours, type I

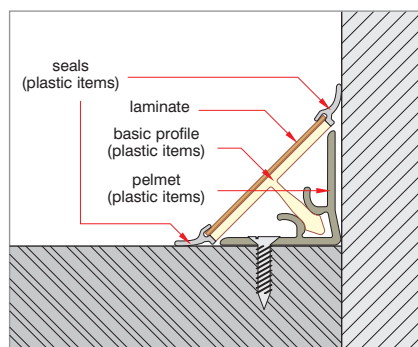

method of mounting splash-back batten in worktop colours, type II

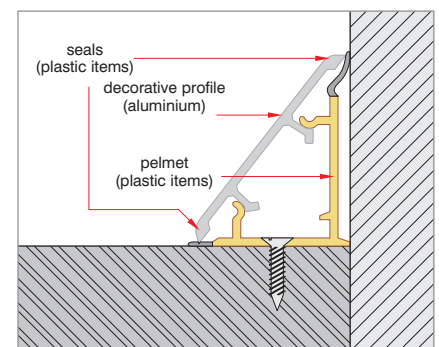

method of mounting aluminium splash-back batten

worktop connectors: aluminium joiner

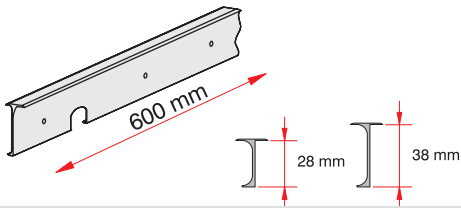

aluminium angle joiner

product description	
aluminium angle joiner to connect # 28 mm worktops	SK-AL-LK-#28
aluminium angle joiner to connect # 38 mm worktops	SK-AL-LK-#38

Please note: strip is designed for worktop shapes with curvature, cannot be applied to worktops White and White XXL or worktops finished with PVC rim.

aluminium gap joiner

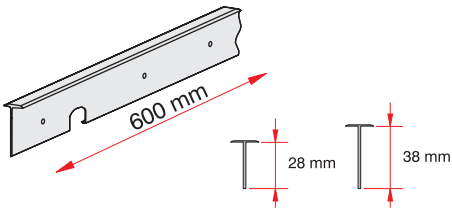

product description	
aluminium gap joiner to join # 28 mm worktops	SK-AL-LSZ-#28
aluminium gap joiner to join # 38 mm worktops	SK-AL-LSZ-#38

Please note: strip is designed for worktop shapes with curvature, cannot be applied to worktops White and White XXL or worktops finished with PVC rim.

aluminium side end

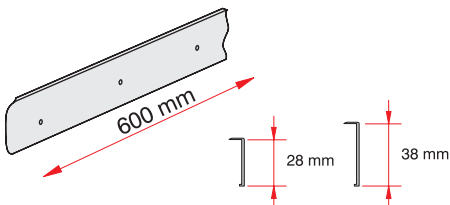

product description	
aluminium left side strip to worktops # 28 mm	SK-AL-LB.L-#28
aluminium right side strip to worktops # 28 mm	SK-AL-LB.P-#28
aluminium left side strip to worktops # 38 mm	SK-AL-LB.L-#38
aluminium right side strip to worktops # 38 mm	SK-AL-LB.P-#38

Please note: strip is designed for worktop shapes with curvature, cannot be applied to worktops White and White XXL or worktops finished with PVC rim.

Application of aluminium side ends and worktop joiners

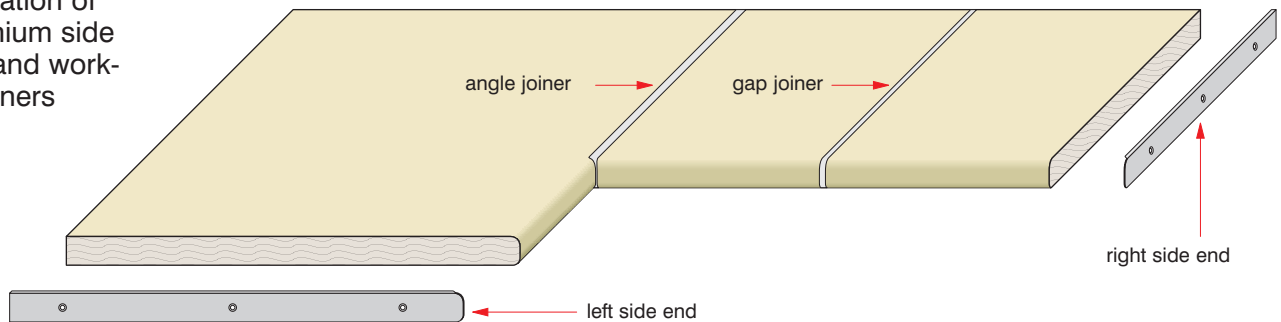

worktop connecting screws

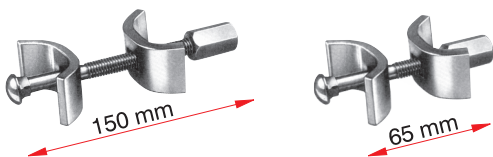

product description	length*	index
standard connecting screw	150	SK-03*OM.ZS150.ZN-SZT
supplementing connecting screw	65	SK-03*OM.ZS65.ZN

* dimensions are given in mm

worktop brackets



Skewed and straight countertop brackets are offered in four colours. Colours, indexes and mounting methods are described on p. 103.



◀ straight worktop brackets, chrome coloured in kitchen Diona Golden Cherry with worktop Sanenberg Beech # 38 mm

aluminium worktop thickening strip



product description	index
aluminium thickening strip for worktops # 38 mm, mounting	SK-06*L.AL/H-40/MN
aluminium thickening strip for worktops # 38 mm, lead	SK-06*L.AL/H-40/CZ
internal corner 90° for aluminium worktops thickening strip	SK-06*N.W.90L.A.40
internal corner 135° for aluminium worktops thickening strip	SK-06*N.W.135L.A.4
external corner 90° for aluminium worktops thickening strip	SK-06*N.Z.90L.A.40
external corner 135° for aluminium worktops thickening strip	SK-06*N.Z.135L.A.4
left end to aluminium worktops thickening strip	SK-06*K.LEWA.L.A.40
right end to aluminium worktops thickening strip	SK-06*K.PRAWA.L.A.40

Worktop thickening strip (mounting and lead) available in lengths:

- 650 mm,
- 1950 mm,
- 3900 mm.

Strip is sold and invoiced in running metres.

method of mounting aluminium worktop thickening strip

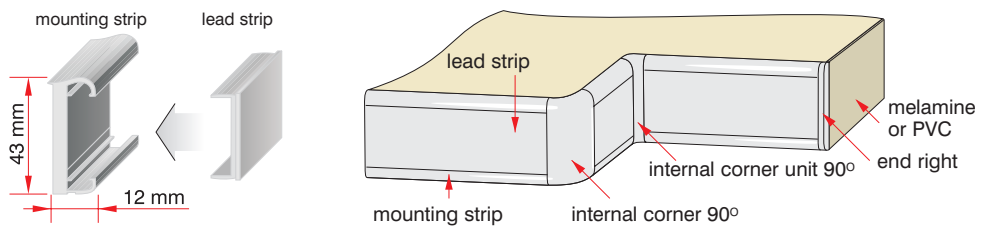

ordering worktops finished with thickening strip

On the sketch the external dimensions of the worktop and other edges which will be finished with thickening strip. In place of strip application cut off worktop will be narrowed by 12 mm (strip thickness)

Standard width of worktop prepared for attaching thickening strip is 588 mm.

ATTENTION: sketch serves only for ordering worktop panels. All accessories (thickening strips, ends, corners, screw joins) shall be ordered separately.

It is not possible finish aluminium worktop strip with a type BU1 ending (corners available only for angles 90° and 135°).

example worktop order with thickening strip

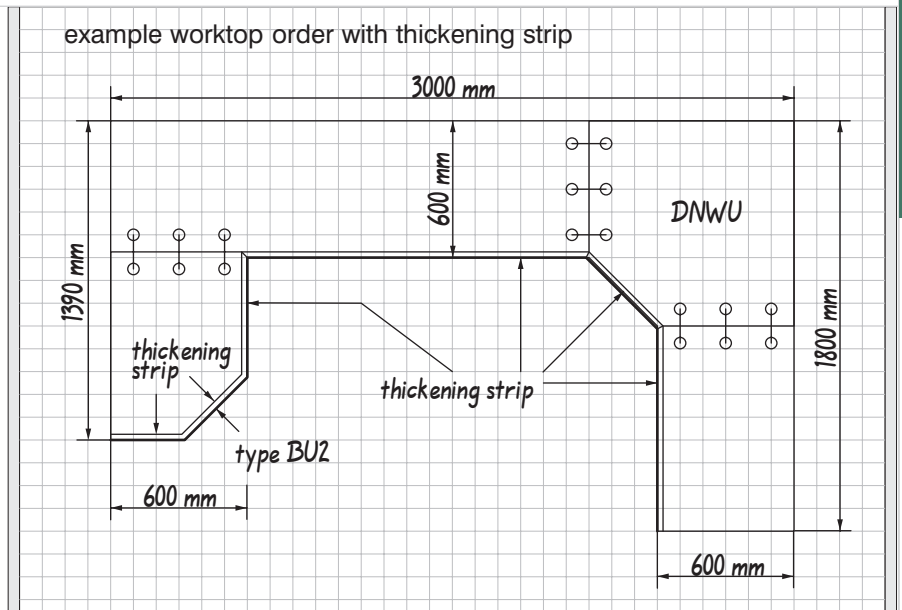

worktop dimensions cut on the basis of order

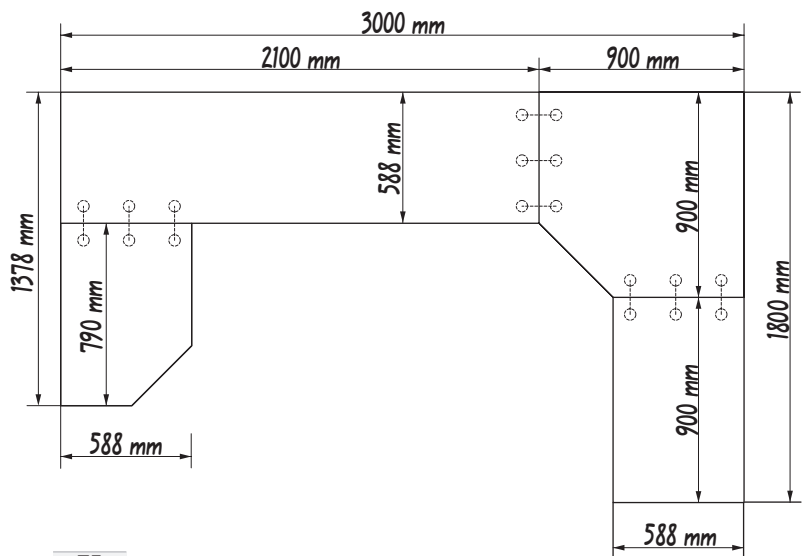

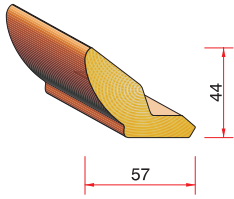

product description	colour	length*	application	index
cornice A	Beech	2700	Sentima, BRW Line	K04-LISTWA-BU-A_2700/66_LW MDF-LIS01
	Calvados Patina	2440	Dekorado	K04-LISTWA-CV_P-A_PVC_2440/66_LW MDF-LIS01
	Windsor Oak	2700	Sentima, BRW Line	K04-LISTWA-DW-A_2700/66_LW MDF-LIS01
	Honey Alder Patina	2700	for kitchen [3]P	K04-LISTWA-OMPA-A_2700/66_LW MDF-LIS01
	San Alder	2700	Sentima, BRW Line	K04-LISTWA-OLS-A_2700/66_LW MDF-LIS01
	Nut Patina	2700	for kitchen [9]	K04-LISTWA-ORPA-A_2700/66_LW MDF-LIS01
	Electra Cherry	2700	Sentima, CL, BL***	K04-LISTWA-WIEL-A_2700/66_LW MDF-LIS01
	Korean Cherry Patina	2700	for kitchen [12]P, Rosa	K04-LISTWA-WIKOP-A_2700/66_LW MDF-LIS01
	Italian Cherry Patina	2440	Ledo	K04-LISTWA-WWP-A_PVC_2440/66_LW MDF-LIS01
cornice A in BRW laminate colours	2440	BRW Line	K04-LISTWA-121-A_PVC_2440/66_LW MDF-LIS01	

* dimensions are given in mm, ** example index glued strip laminate No. 121 (Golden Oak), *** CL, BL - Classic Line, BRW Line

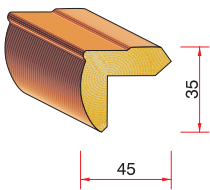

product description	colour	length*	application	index
pelmet A	Beech	2700	Sentima, BRW Line	K04-LISTWA-BU-A_2700/44_LP MDF-LIS01
	Windsor Oak	2700	Sentima, BRW Line	K04-LISTWA-DW-A_2700/44_LP MDF-LIS01
	Honey Alder Patina	2700	for kitchen [3]P	K04-LISTWA-OMPA-A_2700/44_LP MDF-LIS01
	San Alder	2700	Sentima, BRW Line	K04-LISTWA-OLS-A_2700/44_LP MDF-LIS01
	Nut Patina	2700	for kitchen [9]	K04-LISTWA-ORPA-A_2700/44_LP MDF-LIS01
	Electra Cherry	2700	Sentima, CL, BL***	K04-LISTWA-WIEL-A_2700/44_LP MDF-LIS01
Korean Cherry Patina	2700	for kitchen [12]P, Rosa	K04-LISTWA-WIKOP-A_2700/44_LP MDF-LIS01	

* dimensions are given in mm, *** CL, BL - Classic Line, BRW Line

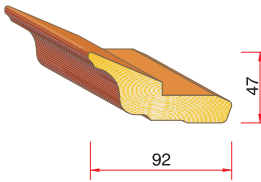

product description	colour	length*	application	index
cornice D	Dark Nut	3000	for kitchen [16]	K04-LISTWA-OC-D_3050/96_LW O-LIS01
curved cornice D , Dark Nut			for kitchen [16]	K04-LISTWA-OC-D_320/96_LW GO-LIS01

* dimensions are given in mm

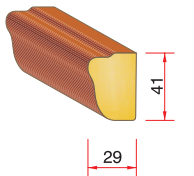

product description	colour	length*	application	index
pelmet D	Dark Nut	3600	for kitchen [16]	K04-LISTWA-OC-D_3600/40_LP F-LIS01
curved pelmet D , Dark Nut			for kitchen [16]	K04-LISTWA-OC-D_300/40_LP GF-LIS01

* dimensions are given in mm

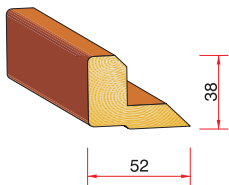

product description	colour	length*	application	index
cornice / pelmet N	Beech	2700	TRAFFIC, BRW Line	K04-LISTWA-BU-N_2700/64_LM DF-LIS01
	Milan Oak	2700	Modern Line, BL****	K04-LISTWA-DMI-N_2700/64_LM DF-LIS01
	Windsor Oak	2700	TRAFFIC, BRW Line	K04-LISTWA-DW-N_2700/64_LM DF-LIS01
	Nida Maple	2700	Modern Line, BL****	K04-LISTWA-KLN-N_2700/64_LM DF-LIS01
	San Alder	2700	TRAFFIC, BRW Line	K04-LISTWA-OLS-N_2700/64_LM DF-LIS01
	Wenge	2700	Modern Line, BL****	K04-LISTWA-WE-N_2700/64_LM DF-LIS01
	Elba Cherry	2700	CAPITAL, ML, BL****	K04-LISTWA-WISE-N_2700/64_LM DF-LIS01
	Electra Cherry	2700	TRAFFIC, ML, BL****	K04-LISTWA-WIEL-N_2700/64_LM DF-LIS01
cornice / pelmet N in BRW laminate colours	2440	BRW Line	K04-LISTWA-121-N_PVC_2440/64_LM DF-LIS01	

* dimensions are given in mm, ** example index glued strip laminate No. 121 (Golden Oak), **** ML, BL - Modern Line, BRW Line

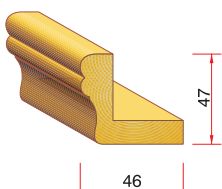

product description	colour	length*	application	index
cornice P	Honey Alder	1200	for kitchen [15]	K04-LISTWA-OM-P_1200/40_LW L-LIS01
	Honey Alder	2100	for kitchen [15]	K04-LISTWA-OM-P_2100/40_LW L-LIS01
	Honey Alder	2700	for kitchen [15]	K04-LISTWA-OM-P_2700/40_LW L-LIS01
curved cornice P , Honey Alder			for kitchen [15]	K04-LISTWA-OM-P_522/40_LW GL-LIS01

* dimensions are given in mm

ATTENTION: P crown strips in lengths of 1500 and 1800 mm are also available until stocks are exhausted

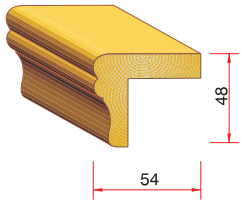

product description	colour	length*	application	index
pelmet P	Honey Alder	1200	for kitchen [15]	K04-LISTWA-OM-P_1200/40_LPL-LIS01
	Honey Alder	2100	for kitchen [15]	K04-LISTWA-OM-P_2100/40_LPL-LIS01
	Honey Alder	2700	for kitchen [15]	K04-LISTWA-OM-P_2700/40_LPL-LIS01
curved pelmet P, Honey Alder			for kitchen [15]	K04-LISTWA-OM-P_522/40_LPGL-LIS01

* dimensions are given in mm

ATTENTION: P pelmet in lengths 1500, 1800 and 2400 mm or also available until stocks are exhausted

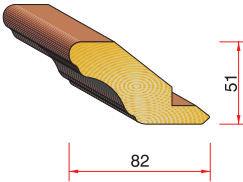

product description	colour	length*	application	index
cornice W	Chestnut	2700	for kitchen [25]	K04-LISTWA-KA-W_2700/94_LWF-LIS01
curved cornice W, Chestnut			for kitchen [25]	K04-LISTWA-KA-W_300/94_LWGF-LIS01
cornice W	Light Chestnut	2700	for kitchen [11]	K04-LISTWA-KAJ-W_2700/94_LWF-LIS01
cornice W	Dark Nut	2700	for kitchen [16]	K04-LISTWA-OC-W_2700/94_LWF-LIS01
curved cornice W, Dark Nut			for kitchen [16]	K04-LISTWA-OC-W_300/94_LWGF-LIS01
cornice W	Walnut	2700	for kitchen [22]	K04-LISTWA-OW-W_2700/94_LWF-LIS01
curved cornice W, Walnut			for kitchen [22]	K04-LISTWA-OW-W_300/94_LWGF-LIS01
cornice W	Morello Cherry	2700	for kitchen [14], Melos	K04-LISTWA-WIS-W_300/94_LWF-LIS01
curved cornice W, Morello Cherry			for kitchen [14]	K04-LISTWA-WIS-W_2700/94_LWGF-LIS01

* dimensions are given in mm

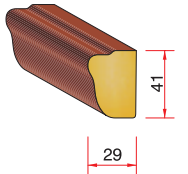

product description	colour	length*	application	index
pelmet W	Chestnut	2700	for kitchen [25]	K04-LISTWA-KA-W_2700/40_LPF-LIS01
curved pelmet W, Chestnut			for kitchen [25]	K04-LISTWA-KA-W_300/40_LPGF-LIS01
pelmet W	Light Chestnut	2700	for kitchen [11]	K04-LISTWA-KAJ-W_2700/40_LPF-LIS01
pelmet W	Dark Nut	2700	for kitchen [16]	K04-LISTWA-OC-W_2700/40_LPF-LIS01
curved pelmet W, Dark Nut			for kitchen [16]	K04-LISTWA-OC-W_300/40_LPGF-LIS01
pelmet W	Walnut	2700	for kitchen [22]	K04-LISTWA-OW-W_2700/40_LPF-LIS01
curved pelmet W, Walnut			for kitchen [22]	K04-LISTWA-OW-W_300/40_LPGF-LIS01
pelmet W	Morello Cherry	2700	for kitchen [14], Melos	K04-LISTWA-WIS-W_2700/40_LPF-LIS01
curved pelmet W, Morello Cherry			for kitchen [14]	K04-LISTWA-OW-W_300/40_LPGF-LIS01

* dimensions are given in mm

mounting cornice and pelmet

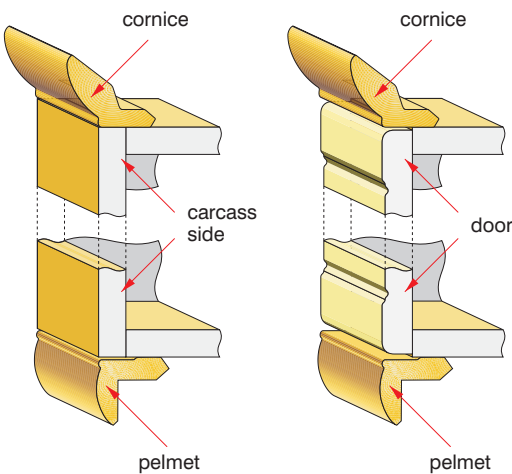

Screws and angle section necessary for mounting is not supplied with cornice and / or pelmet.

The sketches to the side show how to mount the strips and the sizes of screws recommended for particular strips.

ATTENTION: before screwing strips a hole should be made in them for the screws to prevent damaging strips when mounting.

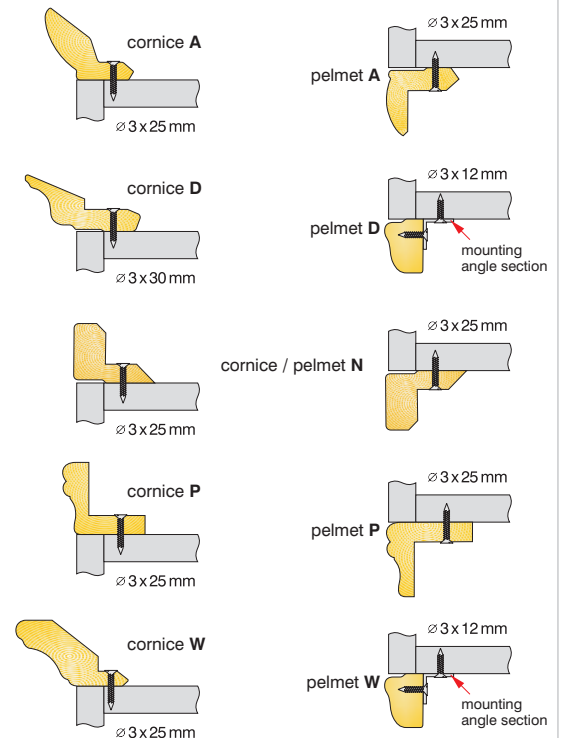

It is recommended that the amount of strip displacement (cornice and / or pelmet) should be equal for both the carcass side and door.

handles group M, group G



handle **M1** /K04-UCHWYT-BK-M1-INN01/
spacing **96 mm**; width/depth 120/25 mm



handle **M4** /K04-UCHWYT-BK-M4-INN01/
spacing **96 mm**; width/depth 114/28 mm



handle **G6** /K04-UCHWYT-BK-G6-INN01/
point wise; width/depth 40/20 mm



handle **M3** /K04-UCHWYT-BK-M3-INN01/
spacing **96 mm**; width/depth 152/29 mm

handle **M2** /K04-UCHWYT-BK-M2-INN01/
spacing **64 mm**; height/depth 120/30 mm



handle **M5** /K04-UCHWYT-BK-M5-INN01/
spacing **96 mm**; width/depth 133/24 mm



handle **G5** /K04-UCHWYT-BK-G5-INN01/
point wise; width/depth 30/25 mm



handle **M6** /K04-UCHWYT-BK-M6-INN01/
point wise; width/depth 143/23 mm



handle **M7** /K04-UCHWYT-BK-M7-INN01/
point wise; width/depth 137/26 mm



handle **M8** /K04-UCHWYT-BK-M8-INN01/
point wise; width/depth 117/23 mm



handle **M9** /K04-UCHWYT-BK-M9-INN01/
spacing **96 mm**; width/depth 110/28 mm



handle **M10** /K04-UCHWYT-BK-M10-INN01/
spacing **64 mm**; width/depth 82/23 mm



handle **M11** /K04-UCHWYT-BK-M11-INN01/
spacing **128 mm**; width/depth 151/33 mm



handle **M12a** /K04-UCHWYT-BK-M12a-INN01/
spacing **96 mm**; width/depth 126/25 mm



handle **M12d** /K04-UCHWYT-BK-M12d-INN01/
point wise; width/depth 42/23 mm



handle **M13a** /K04-UCHWYT-BK-M13a-INN01/
spacing **96 mm**; width/depth 126/25 mm



handle **M13d** /K04-UCHWYT-BK-M13d-INN01/
point wise; width/depth 42/23 mm



handle **M12b** /K04-UCHWYT-BK-M12b-INN01/
spacing **96 mm**; width/depth 128/26 mm



handle **M13b** /K04-UCHWYT-BK-M13b-INN01/
spacing **96 mm**; width/depth 128/26 mm



handle **M12c** /K04-UCHWYT-BK-M12c-INN01/
spacing **96 mm**; width/depth 140/22 mm



handle **M13c** /K04-UCHWYT-BK-M13c-INN01/
spacing **96 mm**; width/depth 140/22 mm



handle **M14** /K04-UCHWYT-BK-M14-INN01/
spacing **96 mm**; width/depth 140/23 mm



handle **G12** /K04-UCHWYT-BK-G12-INN01/
point wise; width/depth 28/16 mm



handle **M15a** /K04-UCHWYT-BK-M15a-INN01/ point wise; width/depth 49/25 mm,
handle **M15b** /K04-UCHWYT-BK-M15b-INN01/ spacing **64 mm**; width/depth 128/25 mm



handle **M17** /K04-UCHWYT-BK-M17-INN01/
spacing **96 mm**; width/depth 144/30 mm



handle **M16a** /K04-UCHWYT-BK-M16a-INN01/ point wise; width/depth 49/25 mm,
handle **M16b** /K04-UCHWYT-BK-M16b-INN01/ spacing **64 mm**; width/depth 128/25 mm



handle **M18** /K04-UCHWYT-BK-M18-INN01/
spacing **96 mm**; width/depth 144/30 mm

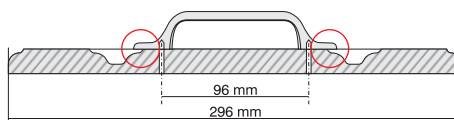

cross-section through type FALA door with mounted M5 handle

ATTENTION: the bases of some handles are significantly wider than their spacing, therefore when choosing handles for doors one must ensure that handle will not encroach on routing;

the above note concerns handles including M3, M5 and M6 mounted on drawer doors 140 x 296 type FALA; in such a situation a knob may be used

handles group P, group G



handle **P1** /K04-UCHWYT-BK-P1-INN01/
spacing **96 mm**; width/depth 107/27 mm



handle **G1** /K04-UCHWYT-BK-G1-INN01/
point wise; width/depth 29/23 mm



handle **P2** /K04-UCHWYT-BK-P2-INN01/
spacing **96 mm**; width/depth 125/31 mm



handle **G2** /K04-UCHWYT-BK-G2-INN01/
point wise; width/depth 29/23 mm



handle **P3** /K04-UCHWYT-BK-P3-INN01/
spacing **96 mm**; width/depth 107/31 mm



handle **G3** /K04-UCHWYT-BK-G3-INN01/
point wise; width/depth 29/23 mm



handle **P4** /K04-UCHWYT-BK-P4-INN01/
spacing **96 mm**; width/depth 107/27 mm



handle **G4** /K04-UCHWYT-BK-G4-INN01/
point wise; width/depth 29/23 mm



handle **P5** /K04-UCHWYT-BK-P5-INN01/
spacing **96 mm**; width/depth 107/27 mm



handle **G13** /K04-UCHWYT-BK-G13-INN01/
point wise; width/depth 29/23 mm



handle **P6** /K04-UCHWYT-BK-P6-INN01/
spacing **96 mm**; width/depth 107/27 mm



handle **G14** /K04-UCHWYT-BK-G14-INN01/
point wise; width/depth 29/23 mm



handle **G7** /K04-UCHWYT-BK-G7-INN01/
point wise; width/depth 44/30 mm

handles group D



handle **D1** /K04-UCHWYT-BK-D1-INN01/
spacing **128 mm**; width/depth 138/36 mm
wooden element in Alder colour



handle **D2** /K04-UCHWYT-BK-D2-INN01/
spacing **128 mm**; width/depth 138/36 mm
wooden element in Nut colour



handle **D3** /K04-UCHWYT-BK-D3-INN01/
spacing **160 mm**; width/depth 170/32 mm
wooden element in Golden Alder colour



handle **D5a** /K04-UCHWYT-BK-D5a-INN01/ spacing **16 mm**; width/depth 28/27 mm
handle **D5b** /K04-UCHWYT-BK-D5b-INN01/ spacing **160 mm**; width/depth 170/27 mm
wooden elements in Wenge colour



handle **D4** /K04-UCHWYT-BK-D4-INN01/
spacing **160 mm**; width/depth 170/32 mm
wooden element in Cherry colour



handle **D6a** /K04-UCHWYT-BK-D6a-INN01/ point wise; width/depth 18/30 mm
handle **D6b** /K04-UCHWYT-BK-D6b-INN01/ spacing **160 mm**; width/depth 169/30 mm
wooden elements in Wenge colour



handle **D7** /K04-UCHWYT-BK-D7-INN01/
spacing **128 mm**; width/depth 198/32 mm
wooden element in Wenge colour

handles group N



handle **N34a** /K04-UCHWYT-BK-N34a-INN01/
spacing **160 mm**; width/depth 172/20 mm
vener in Wenge colour



handle **N34b** /K04-UCHWYT-BK-N34b-INN01/
spacing **160 mm**; width/depth 172/20 mm
vener in Milian Oak colour

handles group N



handle N1 /K04-UCHWYT-BK-N1-INN01/
spacing **96 mm**, width/depth 117/32 mm



handle N2 /K04-UCHWYT-BK-N2-INN01/
spacing **96 mm**, width/depth 124/54 mm



handle N3 /K04-UCHWYT-BK-N3-INN01/
spacing **128 mm**, width/depth 164/25 mm



handle N4 /K04-UCHWYT-BK-N4-INN01/
spacing **128 mm**, width/depth 138/35 mm



handle N5 /K04-UCHWYT-BK-N5-INN01/
spacing **128 mm**, width/depth 152/32 mm



handle N6 /K04-UCHWYT-BK-N6-INN01/
spacing **160 mm**, width/depth 175/20 mm



handle N8a /K04-UCHWYT-BK-N8a-INN01/
spacing **128 mm**, width/depth 170/33 mm



handle N7 /K04-UCHWYT-BK-N7-INN01/
spacing **128 mm**, width/depth 134/28 mm



handle N9 /K04-UCHWYT-BK-N9-INN01/
spacing **160 mm**, width/depth 180/15 mm



handle N8b /K04-UCHWYT-BK-N8b-INN01/
spacing **256 mm**, width/depth 320/33 mm



handle N10 /K04-UCHWYT-BK-N10-INN01/
spacing **128 mm**, width/depth 165/30 mm



handle N8c /K04-UCHWYT-BK-N8c-INN01/
spacing **416 mm**, width/depth 470/33 mm

suggested for door widths (cm)	railing handles				
	N8a	N8b	N8c	N8d	N8e
TAFLA Diona, Hedar	30	45	60	90	120
FORMA	30	45	60	90	---
EKRAN Telesto	30	60	90	120	---



handle N8d /K04-UCHWYT-BK-N8d-INN01/
spacing **2 x 352 mm**, width/depth 770/33 mm



handle N8e /K04-UCHWYT-BK-N8e-INN01/
spacing **2 x 512 mm**, width/depth 1070/33 mm



handle N8v /K04-UCHWYT-BK-N8v-INN01/
spacing **160 mm**, width/depth 220/33 mm



handle N11 /K04-UCHWYT-BK-N11-INN01/
spacing **128 mm**, width/depth 154/25 mm



handle N12 /K04-UCHWYT-BK-N12-INN01/
spacing **128 mm**, width/depth 148/30 mm



handle N13a /K04-UCHWYT-BK-N13a-INN01/
spacing **64 mm**; width/depth 74/22 mm



handle N14 /K04-UCHWYT-BK-N14-INN01/
spacing **128 mm**, width/depth 148/33 mm



handle N15 /K04-UCHWYT-BK-N15-INN01/
spacing **128 mm**, width/depth 179/32 mm

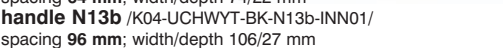

handle N13b /K04-UCHWYT-BK-N13b-INN01/
spacing **96 mm**; width/depth 106/27 mm



handle N16 /K04-UCHWYT-BK-N16-INN01/
spacing **192 mm**, width/depth 260/31 mm



handle N17 /K04-UCHWYT-BK-N17-INN01/
spacing **224 mm**, width/depth 240/28 mm

handles group N, group G



handle N18 /K04-UCHWYT-BK-N18-INN01/
spacing 192 mm, width/depth 207/39 mm



handle N19 /K04-UCHWYT-BK-N19-INN01/
spacing 160 mm, width/depth 185/38 mm



handle N20 /K04-UCHWYT-BK-N20-INN01/
spacing 160 mm, width/depth 182/40 mm

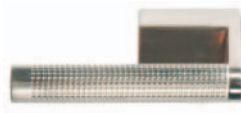

handle N21L /K04-UCHWYT-BK-N21L-INN01/
spacing 32 mm, width/depth 109/46 mm

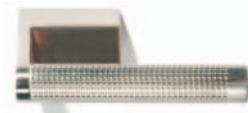

handle N21P /K04-UCHWYT-BK-N21P-INN01/
spacing 32 mm, width/depth 109/46 mm



handle N23
/K04-UCHWYT-BK-N23-INN01/
spacing 16 mm, width/depth 30/23 mm



handle N24 /K04-UCHWYT-BK-N24-INN01/
spacing 16 mm, width/depth 57/23 mm



handle N25
/K04-UCHWYT-BK-N25-INN01/
spacing 64 mm, width/depth 83/23 mm
(arm length 59 mm)



handle N22 /K04-UCHWYT-BK-N22-INN01/
spacing 16 mm, width/depth 30/40 mm



handle N26 /K04-UCHWYT-BK-N26-INN01/
spacing 32 mm; width/depth 60/33 mm



handle N27 /K04-UCHWYT-BK-N27-INN01/
spacing 96 mm; width/depth 104/24 mm



handle N28 /K04-UCHWYT-BK-N28-INN01/
spacing 160 mm; width/depth 168/19 mm



handle N29a /K04-UCHWYT-BK-N29a-INN01/ spacing 16 mm; width/depth 40/20 mm



handle N29b /K04-UCHWYT-BK-N29b-INN01/ spacing 96 mm; width/depth 160/24 mm



handle N30a /K04-UCHWYT-BK-N30a-INN01/ spacing 32 mm; width/depth 48/25 mm



handle N30b /K04-UCHWYT-BK-N30b-INN01/ spacing 128 mm; width/depth 144/25 mm



handle N31a /K04-UCHWYT-BK-N31a-INN01/
spacing 96 mm; width/depth 106/20 mm



handle N31b /K04-UCHWYT-BK-N31b-INN01/
spacing 224 mm; width/depth 234/20 mm



handle N32a /K04-UCHWYT-BK-N32a-INN01/
spacing 96 mm; width/depth 116/30 mm



handle N33a /K04-UCHWYT-BK-N33a-INN01/
spacing 160 mm; width/depth 200/36 mm



handle N32b /K04-UCHWYT-BK-N32b-INN01/
spacing 192 mm; width/depth 214/33 mm



handle N33b /K04-UCHWYT-BK-N33b-INN01/
spacing 320 mm; width/depth 360/36 mm



handle G8
/K04-UCHWYT-BK-G8-INN01/
point wise; width/depth 16/25 mm



handle G9
/K04-UCHWYT-BK-G9-INN01/
point wise; width/depth 16/20 mm



handle G10
/K04-UCHWYT-BK-G10-INN01/
point wise; width/depth 12/21 mm



handle G11
/K04-UCHWYT-BK-G11-INN01/
point wise; width/depth 16/26 mm



dish and cutlery drainer units

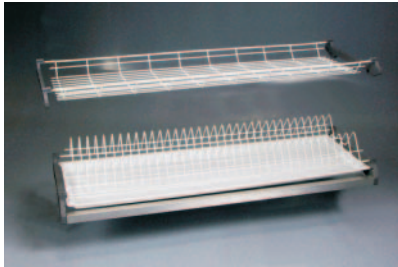

dish and cutlery drainer in colour fluid white

product description	for carcass	colour	index
dish and cutlery drainer or cabinets type GC, may be mounted in cabinets of height 72 or 95 cm ATTENTION: drainers ordered independently from GC cabinets	>I 45 I<	fluid white	SK-03*O.OZP.45AL-NOWA
	>I 45 I<	chrome	SK-03*O.OW2.45CR
	>I 60 I<	fluid white	SK-03*O.OZP.60AL-NOWA
	>I 60 I<	chrome	SK-03*O.OW2.60CR
	>I 80 I<	fluid white	SK-03*O.OZP.80AL-NOWA
	>I 80 I<	chrome	SK-03*O.OW2.80CR
	>I 90 I<	fluid white	SK-03*O.OZP.90AL-NOWA
	>I 90 I<	chrome	SK-03*O.OW2.90CR

cargo baskets



cargo basket for cabinets DCX-15/82-C

product description	for carcass	colour	index
cargo basket for cabinets DCX-15/82-C	>I 15 I<	chrome	SK-03*S.C.XCMBT-15-CR
	>I 15 I<	silver lacquer	SK-03*S.C.XCMBT-15-S
cargo basket for cabinets DC-30/82-C	>I 30 I<	chrome	SK-03*S.C.CM30T-CR
	>I 30 I<	silver lacquer	SK-03*S.C.CM30T-S
cargo basket for cabinets DC-30/207-C/C	>I 30 I<	chrome	SK-03*S.C.CMX-30CR
	>I 30 I<	silver lacquer	SK-03*S.C.CMX-30S

ATTENTION: cargo baskets are ordered separately from DC cabinets; cargo basket for cabinets DCX-15/82-C should be mounted before mounting cabinet

Magic CORNER baskets



cargo basket for cabinets DC-30/82-C
dimensions: 245 / 480 / 510 mm (width/depth/height)

product description	for cabinets	colour	index
Magic basket left	DNW-105/82-P DNWP-105/136-P/B DNWP-105/143-P/B	chrome	SK-03*S.C.KC-L-CR
		silver lacquer	SK-03*S.C.KC-L-S
Magic basket right	DNW-105/82-L DNWL-105/136-L/B DNWL-105/143-L/B	chrome	SK-03*S.C.KC-P-CR
		silver lacquer	SK-03*S.C.KC-P-S
Magic MIDI basket left	DNWP-105/136-P/B DNWP-105/143-P/B	chrome	SK-03*S.C.KCM-L-CR
		silver lacquer	SK-03*S.C.KCM-L-S
Magic MIDI basket right	DNWL-105/136-L/B DNWL-105/143-L/B	chrome	SK-03*S.C.KCM-P-CR
		silver lacquer	SK-03*S.C.KCM-P-S

ATTENTION: Magic CORNER baskets are ordered separately from cabinets DNW / DNWL and DNWP



cargo basket for cabinets DC-30/207-C/C
dimensions: 250 / 500 / 1800-2250 mm (width/depth/height)



Magic basket for application in corner cabinets
DNW-105/82-L (-P)
DNWL(P)-105/136-L (-P),
DNWL(P)-105/143-L (-P)
attached: to bottom of carcass;
dimensions: 670 / 500 / 580 mm (width/depth/height)

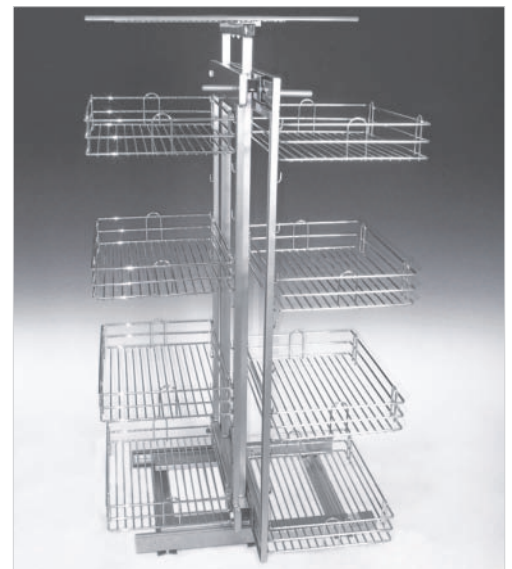

Magic MIDI basket for application in corner cabinets
DNWL(P)-105/136-L (-P),
DNWL(P)-105/143-L (-P)
attached: to bottom of upper crown of carcass;
dimensions: 670 / 500 / 1100-1500 mm (width/depth/height)

wicker basket



product description	for cabinets	colour	index
wicker baskets for cabinets DSY-45/82 and DSY-60/82 are sold in sets (basket + guide rails); Available colours for arms and guide rails: - Beech, - Alder, - Nut, - Morello Cherry	DSY-45/82	Beech	SK-BU-KOSZ WIKLINOWY 45_KPL
		Alder	SK-OL-KOSZ WIKLINOWY 45_KPL
		Nut	SK-OR-KOSZ WIKLINOWY 45_KPL
		Morello Cherry	SK-WIS-KOSZ WIKLINOWY 45_KPL
	DSY-60/82	Beech	SK-BU-KOSZ WIKLINOWY 60_KPL
		Alder	SK-OL-KOSZ WIKLINOWY 60_KPL
		Nut	SK-OR-KOSZ WIKLINOWY 60_KPL
		Morello Cherry	SK-WIS-KOSZ WIKLINOWY 60_KPL

ATTENTION: wicker baskets are ordered separately from cabinets DSY and sold in sets - wicker basket + guide rails; for each DSY type cabinet order 3 sets of wicker baskets

rotating shelves / carousels

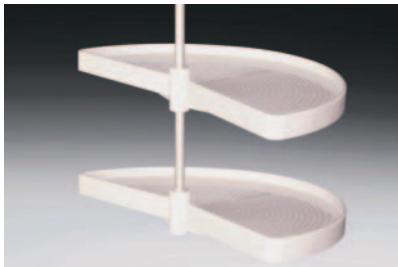

rotating shelf 1/2 circle, plastic recommended for corner cabinets DNW-105/82-L (-P)

product description	diameter*	colour	index
rotating shelf 1/2 circle (plastic)	750	white	SK-03*PO.P1/2.750B
rotating shelf 1/2 circle	750	silver lacquer	SK-03*PO.1/2750S
rotating shelf 3/4 circle	750	chrome	SK-03*PO.3/4750B-CR
rotating shelf 3/4 circle	750	silver lacquer	SK-03*PO.3/4750B-99S
rotating shelf cut off	750	chrome	SK-03*PO.S750B-OCR
rotating shelf cut off	750	silver lacquer	SK-03*PO.S750S-OS97

ATTENTION: offered rotating shelves may have minor differences from those illustrated

* dimensions are given in mm

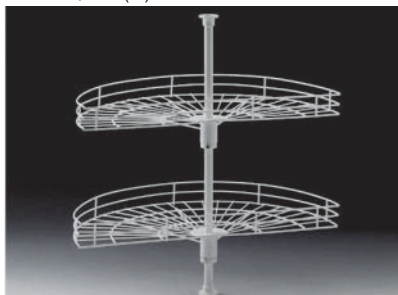

rotating shelf 1/2 circle recommended for corner cabinets DNW-105/82-L (-P)



rotating shelf 3/4 circle recommended for corner cabinets DNW-90/82-L/L (-P/P)



rotating shelf cut off recommended for corner cabinets DNWU-90/82-L (-P)

waste bin



product description	frame colour	bin colour	index
single waste bin	silver lacquer	marble	SK-03*EW.SP.J.W-MR-S
double waste bin	silver lacquer	marble	SK-03*EW.SP.W-MR-S
automatic waste bin		white	SK-03*KS.PC-BI
		ash + chrome	SK-03*KS.PC-CR



single waste bin with partially protruding ball slide; attached: to side wall of carcass; dimensions: 230 / 450 / 430 mm (width/depth/height) capacity: 10 L



double waste bin with partially protruding roller slide; attached: to bottom of carcass; dimensions: 330 / 450 / 400 mm (width/depth/height) capacity: 2 x 10 L



automatic waste bin opens automatically when cabinet opened; attached: for cabinet door; dimensions: 360 / 355 / 355 mm (width/depth/height) capacity: 13 L

EKKO-SYSTEM module waste bin also available in offer, p. 84 >>>

EKKO-SYSTEM

EKKO-SYSTEM module waste bin

EKKO-SYSTEM module waste bin functionally and easily separates waste.

Bins are available in three sizes:

- MINI** - module 140/210, height 275 mm, capacity 6 L;
- MIDI** - module 210/280, height 275 mm, capacity 13,5 L;
- MAXI** - module 210/420, height 275 mm, capacity 21 L;

Each of the bins is equipped with folding handles, which also serve to hold waste bags (picture opposite). Bins are sold as a set with lid. TANDEMBOX drawers are available with special mats to prevent bins moving.

EKKO-SYSTEM is designated mainly for application in TANDEMBOX drawers (with mat or without) and METABOX (without mats).

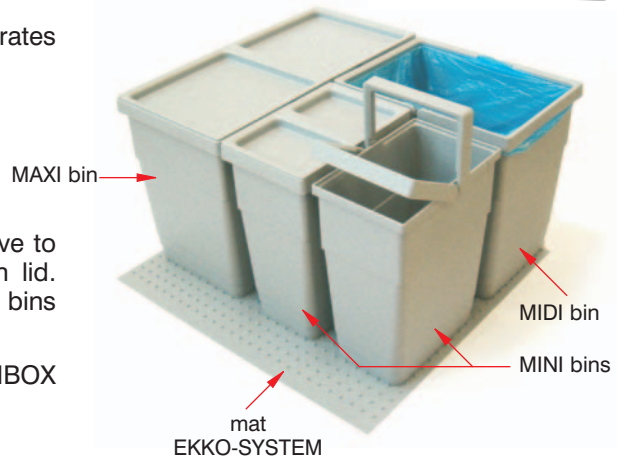

product description	for carcass	colour	index
MINI bin with lid		grey	SK-EKKO-POJ_MINI_KPL-SZ
MIDI bin with lid		grey	SK-EKKO-POJ_MIDI_KPL-SZ
MAXI bin with lid		grey	SK-EKKO-POJ_MAXI_KPL-SZ
EKKO-SYSTEM mat for TANDEMBOX drawers	> 45 <	grey	SK-EKKO-MATA_TANDEMBOX_45-SZ
	> 60 <	grey	SK-EKKO-MATA_TANDEMBOX_60-SZ
	> 90 <	grey	SK-EKKO-MATA_TANDEMBOX_90-SZ

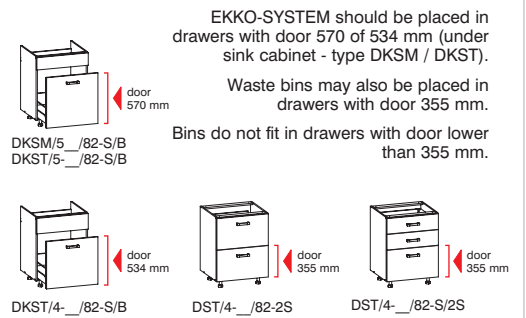

example application in drawers >| 45 cm |< with TANDEMBOX drawer

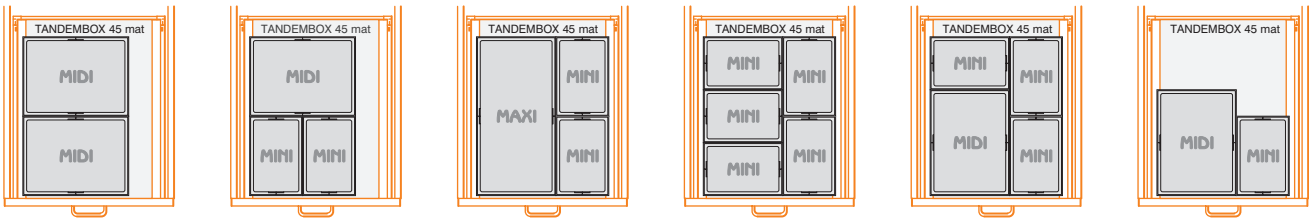

example application in drawers >| 60 cm |< with TANDEMBOX drawer

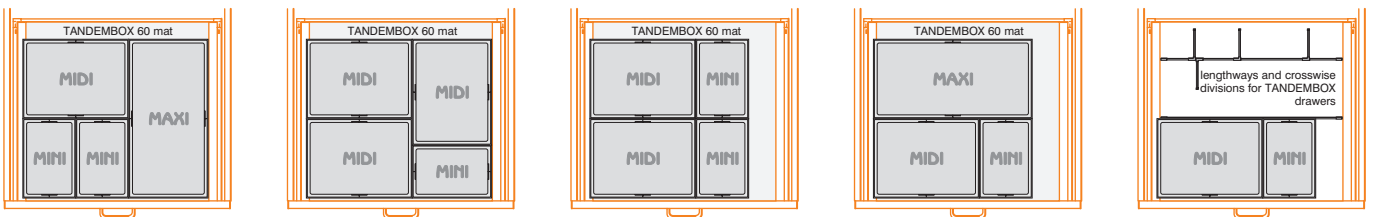

example application in drawers >| 90 cm |< with TANDEMBOX drawer

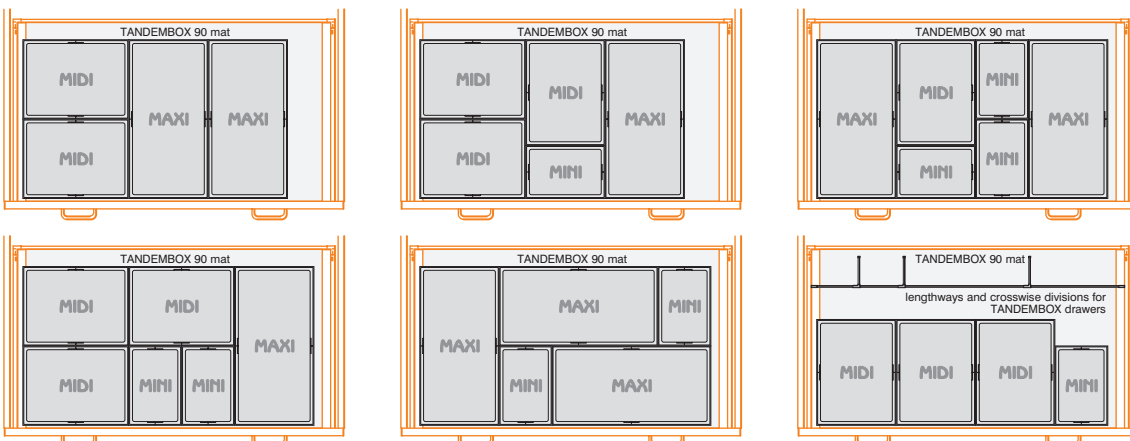

Application of EKKO-SYSTEM bins in COMBI type drawers

inserts for METABOX drawers



product description	for carcass	index
inserts for METABOX drawers made of plastic; colour: white; dimensions matched to METABOX drawers	>I 30 I<	SK-BI-WKLAD_METABOX_30
	>I 45 I<	SK-BI-WKLAD_METABOX_45
	>I 60 I<	SK-BI-WKLAD_METABOX_60
	>I 90 I<	SK-BI-WKLAD_METABOX_90

METABOX 30

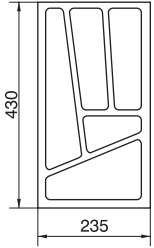

METABOX 45

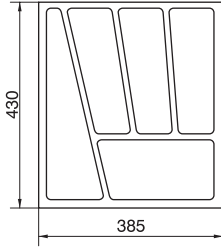

METABOX 60

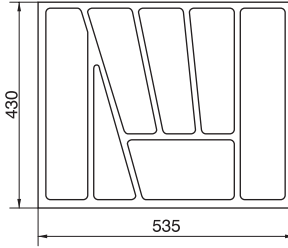

METABOX 90

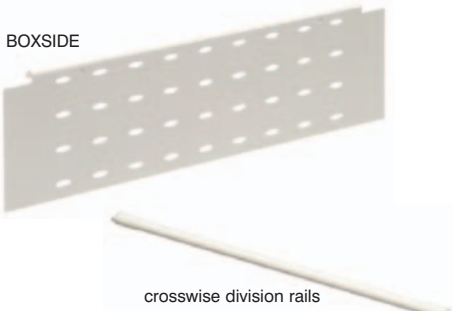
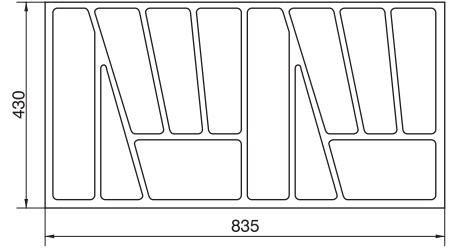

BOXSIDE

crosswise division rails

accessories for METABOX with high door



product description	for carcass	index
BOXSIDE, colour: white		SK-BI-BOXSIDE_SMR-KPL
rails for crosswise division sold in sets of two items; colour: white	>I 30 I<	SK-BI-RELING_SMR_30-KPL
	>I 45 I<	SK-BI-RELING_SMR_45-KPL
	>I 60 I<	SK-BI-RELING_SMR_60-KPL
	>I 90 I<	SK-BI-RELING_SMR_90-KPL

BOXSIDE and crosswise division rails may only be applied in METABOX high drawers with rails.

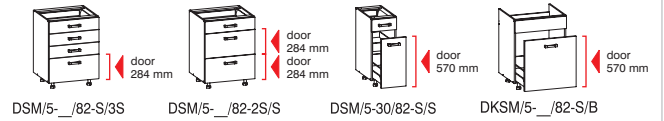

DSM/5-_/82-S/S

DSM/5-_/82-2S/S

DSM/5-30/82-S/S

DKSM/5-_/82-S/B

inserts to TANDEM BOX drawers



product description	for carcass	index
inserts to TANDEM BOX drawers made of plastic; colour: silver; dimensions matched to TANDEMBOX drawers	>I 30 I<	SK-SRE-WKLAD_TANDEMBOX_30
	>I 45 I<	SK-SRE-WKLAD_TANDEMBOX_45
	>I 60 I<	SK-SRE-WKLAD_TANDEMBOX_60
	>I 90 I<	SK-SRE-WKLAD_TANDEMBOX_90
	>I 120 I<	SK-SRE-WKLAD_TANDEMBOX_120

TANDEMBOX 30

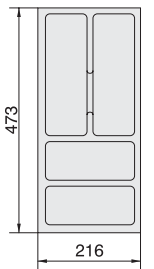

TANDEMBOX 45

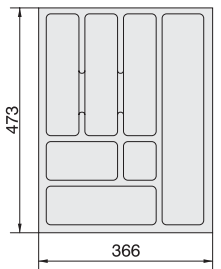

TANDEMBOX 60

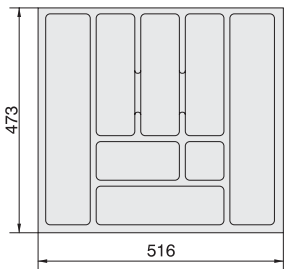

TANDEMBOX 90

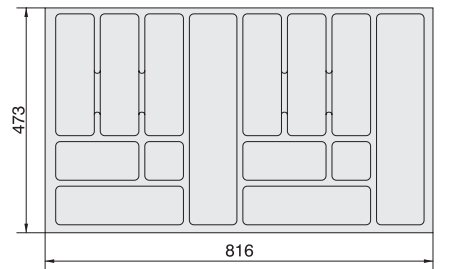

TANDEMBOX 120

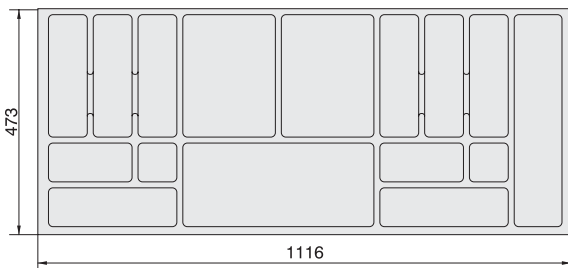

For TANDEMBOX drawers with low doors **blum** organisers are also available p. 87-89



due to adjustable width the rank is adjustable to plate size

ORGA-LINE drawer organisation system

ORGA-LINE by *blum*

The ORGA-LINE system enables adaptation of the usable space of the drawers to individual needs. The ORGA-LINE system is composed of:

- lengthways and crosswise drawer dividers,
- plate rack
- knife insert,
- organisers,
- tray and rack for bottles,
- BOXSIDE side,

all above items (with the exception of plate rack) May only be applied in TANDEMBOX drawers.



drawer dividers enable organisation in drawers



COMBI drawer with separate place for bottles



drawer organisers described on next page

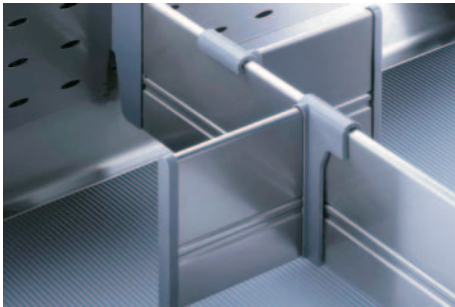

lengthways and crosswise drawer dividers

ORGA-LINE by *blum*

product description	for carcass	index
crosswise divider colour: grey crosswise divider 45 may also be applied in corner cabinets type DNWUST/4 and DNWUST/5	>I 45 I<	SK-Z40H327S_PODZIAL_POPRZECZNY_45
	>I 60 I<	SK-Z40H477S_PODZIAL_POPRZECZNY_60
	>I 90 I<	SK-Z40H777S_PODZIAL_POPRZECZNY_90
	>I 120 I<	SK-Z40H1077S_PODZIAL_POPRZECZNY_120
COMBI 90 crosswise division, colour: grey		SK-PODZIAL_COMBI_90_ST
lengthways division, colour: grey		SK-Z43H100S.01_PODZIAL_PODLUZNY

crosswise divisions

COMBI 90 crosswise division

lengthways division

example applications of divisions in drawers

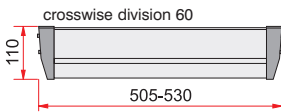
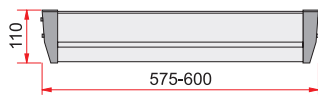
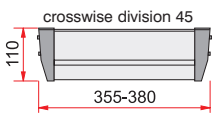

ATTENTION: COMBI 90 crosswise division may only be applied in TANDEM BOX 90 type COMBI draws the separate place for bottles (sketch beside); COMBI type drawer described on p. 91

TANDEM BOX 30 drawer may be divided for use of bottle rack (p. 90)

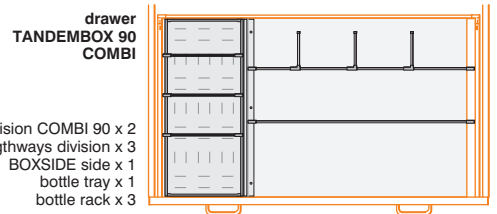
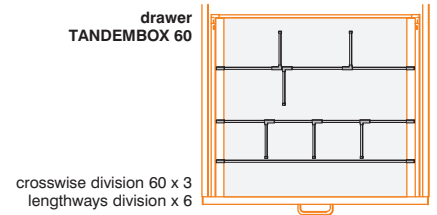
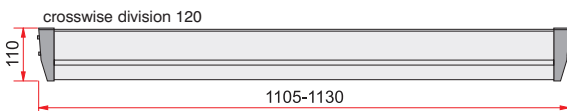
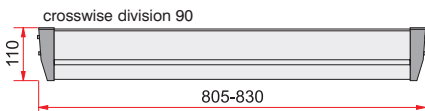

more drawer division application examples p. 84, 90-91

Crosswise and lengthways divisions are designated for TANDEM BOX high drawers (door height 284 mm and more)

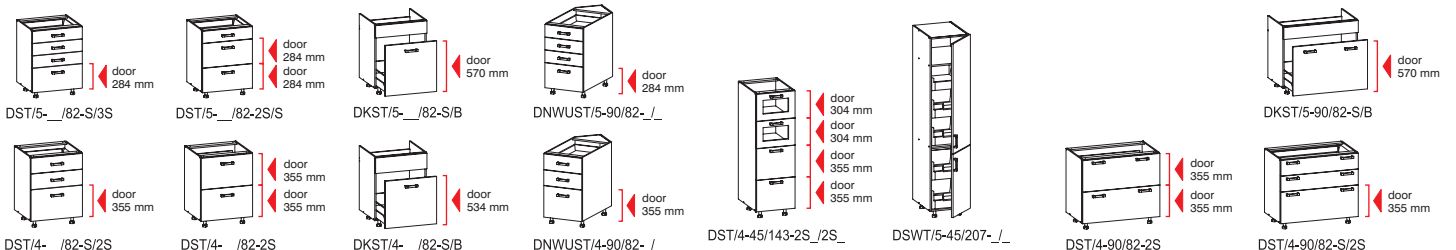

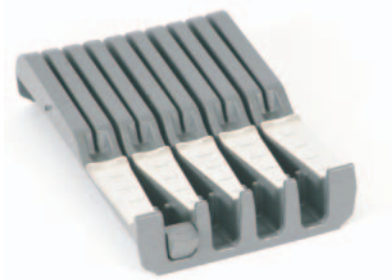

plate rack

ORGA-LINE by **blum**



product description	index
<p>plate rack enable safe storage of plates in drawers, easy access; adjustable width matches rack to plate diameter (from hundred and 180 to 320 mm) height: total 174 mm, height of plate rack 144 mm colour: grey</p>	<p>SK-UCHWYT NA TALERZE ZTH.0350</p>



knives insert

ORGA-LINE by **blum**



product description	index
<p>insert for knives may hold nine knives of different sizes; long, heavy knives may be supported on additional supports; insert may fit inside organizer ZSI.500FI3, between two organisers or separately attached to bottom of drawer dimensions: width 177,5, length 260 mm; colour: grey</p>	<p>SK-UCHWYT_NOZE_ZSZ.02M0</p>

example applications of knife insert are shown on p. 88 >>>



kitchen drawer organizers [11] Strategio XI Mądry

TANDEMBOX drawer organisers

ORGA-LINE by **blum**



Allow tidy placing of cutlery and other kitchen tools and ergonomic use of drawer space. Module containers are made from stainless steel and may be individually taken out e.g. on the table during barbecues in the garden and placed in the drawer in the desired arrangement.

Organisers are sold individually (ZSI.500MI3, ZSI.500FI3, ZSI.500BI3, ZSI.650FI2, ZSI.650BI3) do not completely fill drawers. In wide drawers more than one organiser may be fitted.

We also can offer an organisers in sets (ZSI.60VEI6, ZSI.90VEI6, ZSI.45VEI6) which completely fill the insides of TANDEMBOX drawers 45, 60 and 90 cm.

Anti-slip mats and knife inserts can also be applied with drawer organizers.



Removable cant may be dishwasher

TANDEMBOX drawer organisers sold singly

product description	designation	index
<p>organisers for standard TANDEM BOX drawers applied in drawer types D1ST/4, DST/4, D1ST/5, DST/5 colour: grey, chrome</p>	cutlery, kitchen tools	SK-WKLAD SZUFLADY ZSI.500BI3
	working cutlery, kitchen tools	SK-WKLAD SZUFLADY ZSI.500FI3
	cutlery, kitchen tools	SK-WKLAD SZUFLADY ZSI.500MI3
<p>organisers for extended TANDEMBOX drawers applied in drawer types DNWUST/4, DNWUST/5 colour: grey, chrome</p>	cutlery, kitchen tools	SK-WKLAD_SZUFLADY_ZSI.650BI3
	working cutlery, kitchen tools	SK-WKLAD_SZUFLADY_ZSI.650FI2

TANDEMBOX drawer organisers sold in sets

product description	for carcass	designation	index
<p>organisers for standard TANDEM BOX drawers applied in drawer types D1ST/4, DST/4, D1ST/5, DST/5 colour: grey, chrome</p>	> 45 <	cutlery, kitchen tools	SK-WKLAD_SZUFLADY_ZSI.45VEI6
	> 60 <	cutlery, kitchen tools	SK-WKLAD_SZUFLADY_ZSI.60VEI6
	> 90 <	cutlery, kitchen tools	SK-WKLAD_SZUFLADY_ZSI.90VEI6

characteristics of particular organisers and examples of use are shown on p. 88-89 >>>

organisers for standard TANDEM BOX drawers

BI3, MI3 and FI3 organisers may be applied singly or they may be used to create one's own arrangement according to individual need.

BI3 and **MI3** organisers are placed against drawer sides. The **FI3** organiser should be separated from drawer sides so creating an additional space.

ZSI.500BI3

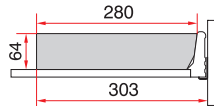

ZSI.500MI3

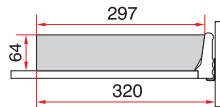

ZSI.500FI3

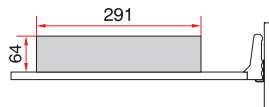

ORGANISERS are designated for low TANDEMBOX drawers (door heights 140 and 176 mm) in lower cabinets of standard carcass depth (508 mm)

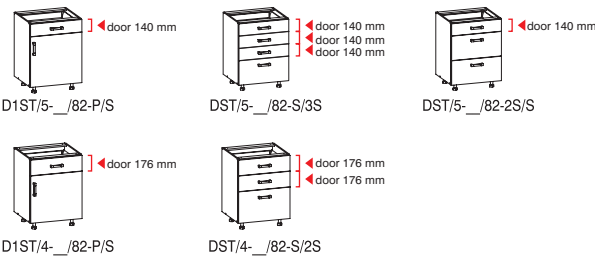

example use of drawer organisers

ORGA-LINE by **blum**

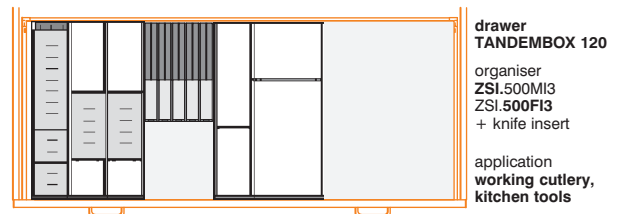
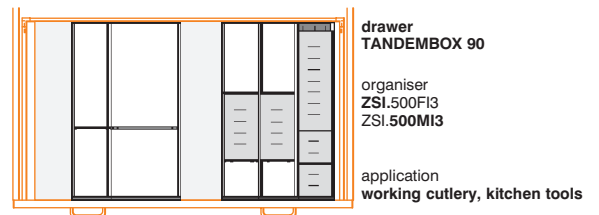
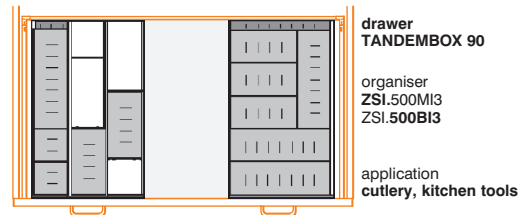
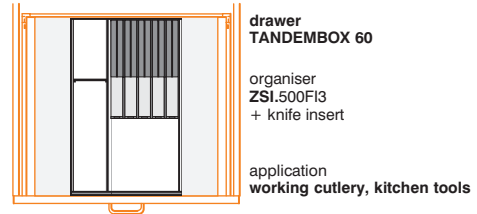
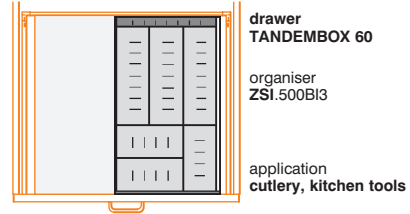
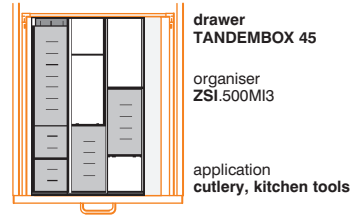

Calculation of free space in drawer

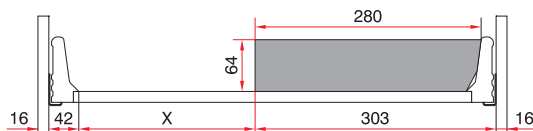

$$X = \text{carcass width} - 32 - \text{organiser width}^* - \text{guides width}^*$$

Example:
 $X = 600 - 32 - 303 - 42 = 223$

* width of organiser and guide width counted from inside of carcass panel

organisers for extended TANDEMBOX drawers

B13 organiser is placed against drawer side.
The **F13** organiser should be separate from drawer sides.

ZSI.650B13

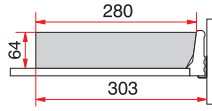

ZSI.650F12

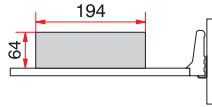

ORGANISERS ZSI.650F12 and ZSI.650B13 are designated for low TANDEMBOX of drawers (door heights 140 and 176 mm) in drawer types DNWUST/4 and DNWUST/5

example use of drawer organisers

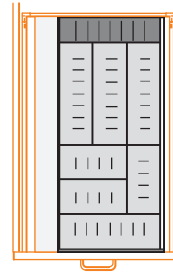

drawer
TANDEMBOX 45 (extended)
organiser
ZSI.650B13

application
cutlery, kitchen tools

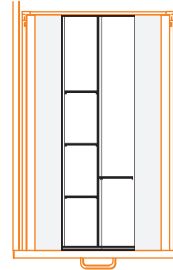

drawer
TANDEMBOX 45 (extended)
organiser
ZSI.650F12

application
working cutlery, kitchen tools



DNWUST/5-90/82-2S/S



DNWUST/5-90/82-S/3S



DNWUST/4-90/82-S/2S

organisers in sets for standard TANDEMBOX drawers

ZSI.45VEI6



ZSI.60VEI6



ZSI.90VEI6



example management of drawers with organisers in sets

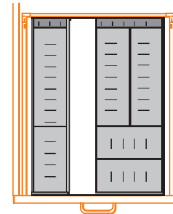

drawer
TANDEMBOX 45
organiser
ZSI.45VEI6

application
cutlery, kitchen tools



drawer
TANDEMBOX 60
organiser
ZSI.60VEI6

application
cutlery, kitchen tools

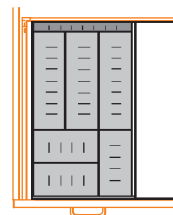

drawer
TANDEMBOX 90
organiser
ZSI.90VEI6

application
cutlery, kitchen tools

ORGANISERS in sets designated for low TANDEMBOX drawers (door height 140 and 176 mm) in lower cabinets of standard carcass depth (508 mm)



D1ST/5-_/82-P/S



DST/5-_/82-S/3S



DST/5-_/82-2S/S



D1ST/4-_/82-P/S



DST/4-_/82-S/2S

drawer for bottles

ORGA-LINE by *blumi*



bottle rack

bottle tray

remaining drawers in which bottle tray and/or rack may be placed

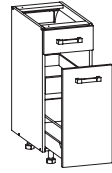

DST/5-30/82-S/S

In cabinet DST/5-30/82-S/S an internal drawer is applied. Due to this lower drawer solution one may store bottles e.g. oil or vinegar. Storage in drawers enables quick and easy access to these products. The lower drawer may be additionally equipped with tray and/or bottle rack.

Bottle tray protects drawer bottom from split liquids (oil, vinegar, chemical cleaning liquid etc). Apart from cabinet DST/5-30/82-S/S tray may be also applied in TANDEMBOX 30 drawers of door height 284 or 355 mm (NOTE: tall bottles do not fit in drawers of height 284 mm).

Bottle racks help keep order in drawers and prevent bottles from falling over. Bottle racks may also be placed in other TANDEMBOX 30 high drawers. Rack is attached to drawer sides (in drawers of width 30 cm) or between side a drawers and BOXSIDE side (in TANDEMBOX 45 drawers and wider).

use of trays and racks is possible in drawers of width 45 cm plus after mounting BOXSIDE side to drawer bottom

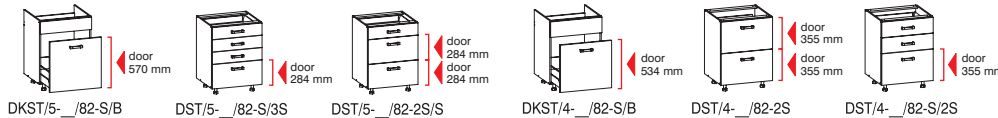

ATTENTION: tray and bottle rack can only be fitted in TANDEMBOX drawers

examples of tray and bottle rack application are shown on p. 86, 91

BOXSIDE partition

ORGA-LINE by *blumi*

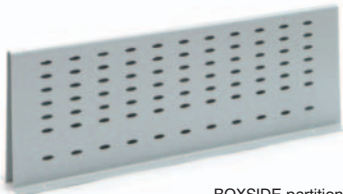

BOXSIDE partition designated only for TANDEMBOX drawers

product description	index
BOXSIDE partition, colour: grey	SK-BOXSIDE_COMBI_ST

BOXSIDE partition is attached to the bottom of high TANDEMBOX drawers and divides their interior in two parts. BOXSIDE partition is attached to bottom of drawer.

By using BOXSIDE partition one may separate a place for bottles. A drawer so divided is called COMBI, described on opposite page.

example use of BOXSIDE partition in TANDEMBOX drawers

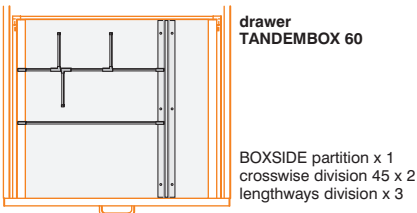
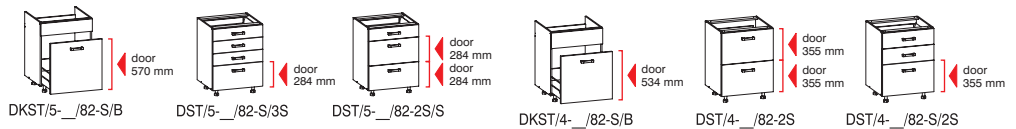

drawer TANDEMBOX 60

BOXSIDE partition x 1 crosswise division 45 x 2 lengthways division x 3

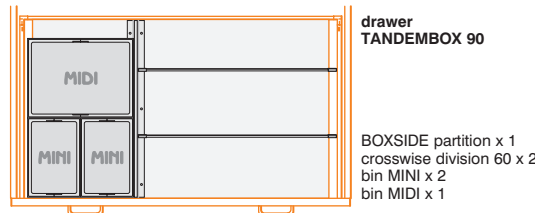

drawer TANDEMBOX 90

BOXSIDE partition x 1 crosswise division 60 x 2 bin MINI x 2 bin MIDI x 1

examples of use of BOXSIDE partitions are also shown on p. 86, 91

anti-slip mat for TANDEMBOX drawers



product description	index
anti-slip mat for TANDEMBOX drawers prevents objects kept in drawers becoming mixed up; dimensions are matched to drawer bottom with TANDEMBOX guides (only in lower cabinet drawers) colour: silver	SK-SRE-MATA_TANDEMBOX_30
	SK-SRE-MATA_TANDEMBOX_45
	SK-SRE-MATA_TANDEMBOX_60
	SK-SRE-MATA_TANDEMBOX_90
	SK-SRE-MATA_TANDEMBOX_120

COMBI type TANDEMBOX drawer

ORGA-LINE by *blum*

A **COMBI** drawer is a **TANDEMBOX** drawer 60 or 90 cm with door of height 355 or 570 mm, in which with the aid of a **BOXSIDE partition** a space for bottles is separated. A **BOXSIDE** partition may also divide interiors of drawers with door of height 284 mm, but tall bottles i.e. spices, vinegar or oil will not fit in such a drawer.

Please note: **COMBI** drawers with **BOXSIDE** partition may not be made with **METABOX** guides.

COMBI drawers are mainly in sink units cabinet type DKST/5 and DKST/4, and also may be fitted in type DS/4 cabinets:

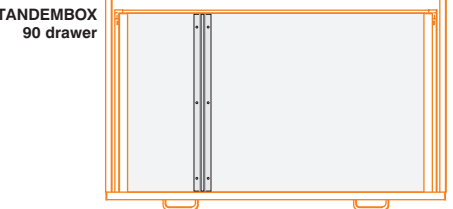
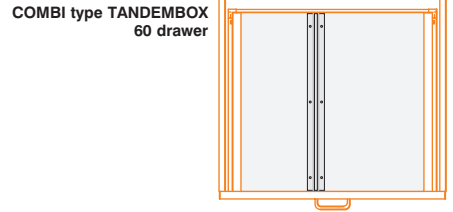

BOX SIDE partition may be mounted in COMBI drawers on left (as in sketch above) or on right side of drawer

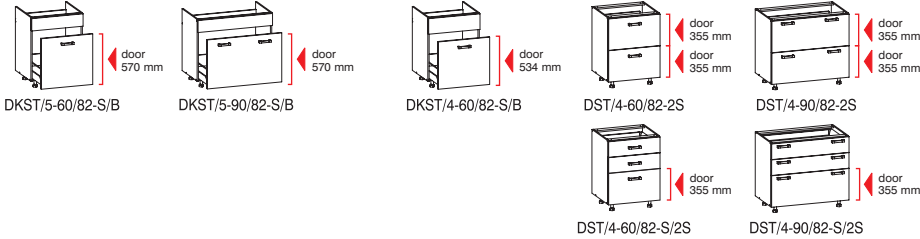

application of COMBI drawers



In **COMBI** type drawers the **BOXSIDE** partition separates a place for bottles and various types of vertical containers.

COMBI drawers enable simple space planning and easy access to the contents. Application of **trays** and **bottle racks** additionally protects the drawer interior and its contents.

COMBI type drawers are applied primarily in **type DKST/5 sink units cabinets**. The waste bin is most often under the sink with the cleaning liquids, cloths and brushes etc.

In kitchens with 4-drawer layout, **COMBI** type drawers may be applied in **cabinet DS/4**, which is under or beside the hot plates. In the separated sector one may keep cooking oil, olive oil, vinegar and other products in bottles and tall containers.

The pictures above show TANDEMBOX COMBI 90 cm drawer in cabinet DKST/5-90/82-S/B.

- apart from **BOXSIDE** partition it is equipped with:
- bottle tray (1 item),
 - bottle rack (1 set - 3 items),
 - crosswise divisions COMBI 90 (2 items; one supporting waste bin),
 - lengthways divisions (3 items),
 - waste bins MIDI, EKKO-SYSTEM (two sets - bin + lid).

example equipment of COMBI type TANDEMBOX drawer

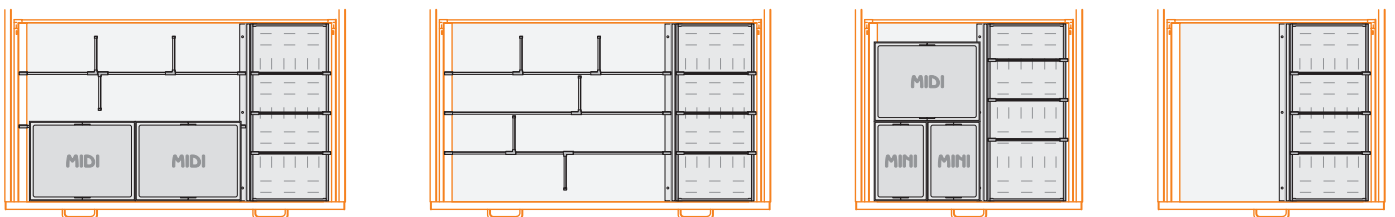

drawer scheme shown in pictures

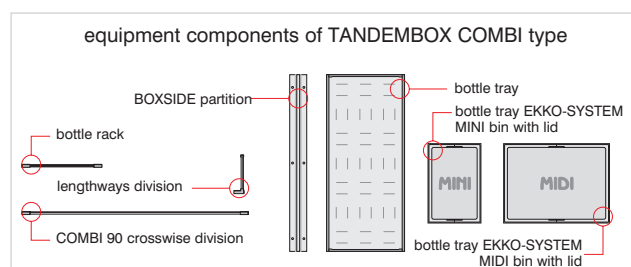

ADVERTISEMENT





MAXIMA Line
ORGANISER SYSTEM

REJS Spółka z o.o.
87-500 Rypin, ul. Mławska 61
POLAND

tel.: +48 (0) 54 280 5651/5186/5190
fax: +48 (0) 54 280 6192
email: rejs@rejs-am.pl

ADVERTISEMENT

rail components

product description	colour	index
rail tube \varnothing 16 mm, length 600 mm	chrome	SK-03*R.L600-CR
	brass	SK-03*R.L600-MS
	brass patina	SK-03*R.L600-PT
	nickel-satin	SK-03*R.L600-NS
rail tube \varnothing 16 mm, length 1000 mm	chrome	SK-03*R.L100-CR
	brass	SK-03*R.L100-MS
	brass patina	SK-03*R.L100-PT
	nickel-satin	SK-03*R.L100-NS
90° rail bend, \varnothing 16 mm	chrome	SK-03*R.LR90-CR
	brass	SK-03*R.LR90-MS
	brass patina	SK-03*R.LR90-PT
	nickel-satin	SK-03*R.LR90-NS
135° rail bend, \varnothing 16 mm	chrome	SK-03*R.LR135-CR
	brass	SK-03*R.LR135-MS
	brass patina	SK-03*R.LR135-PT
	nickel-satin	SK-03*R.LR135-NS
retro rail holder	chrome	SK-03*R.UR-CR
	brass	SK-03*R.UR-MS
	brass patina	SK-03*R.UR-PT
	nickel-satin	SK-03*R.UR-NS
straight rail holder	chrome	SK-03*R.UP-CR
	brass	SK-03*R.UP-MS
	nickel-satin	SK-03*R.UP-NS
	retro rail stopper	chrome
brass		SK-03*R.ZR-MS
brass patina		SK-03*R.ZR-PT
nickel-satin		SK-03*R.ZR-NS
straight rail stopper	chrome	SK-03*R.ZP-CR
	brass	SK-03*R.ZP-MS
	nickel-satin	SK-03*R.ZP-NS
	retro holder seat	chrome
brass		SK-03*R.PR-MS
brass patina		SK-03*R.PR-PT
nickel-satin		SK-03*R.PR-NS
rail connector	plastic	SK-03*R.LR-00



rail tube



90° rail bend



135° rail bend



retro rail holder



straight rail holder



retro rail stopper



straight rail stopper



retro holder seat

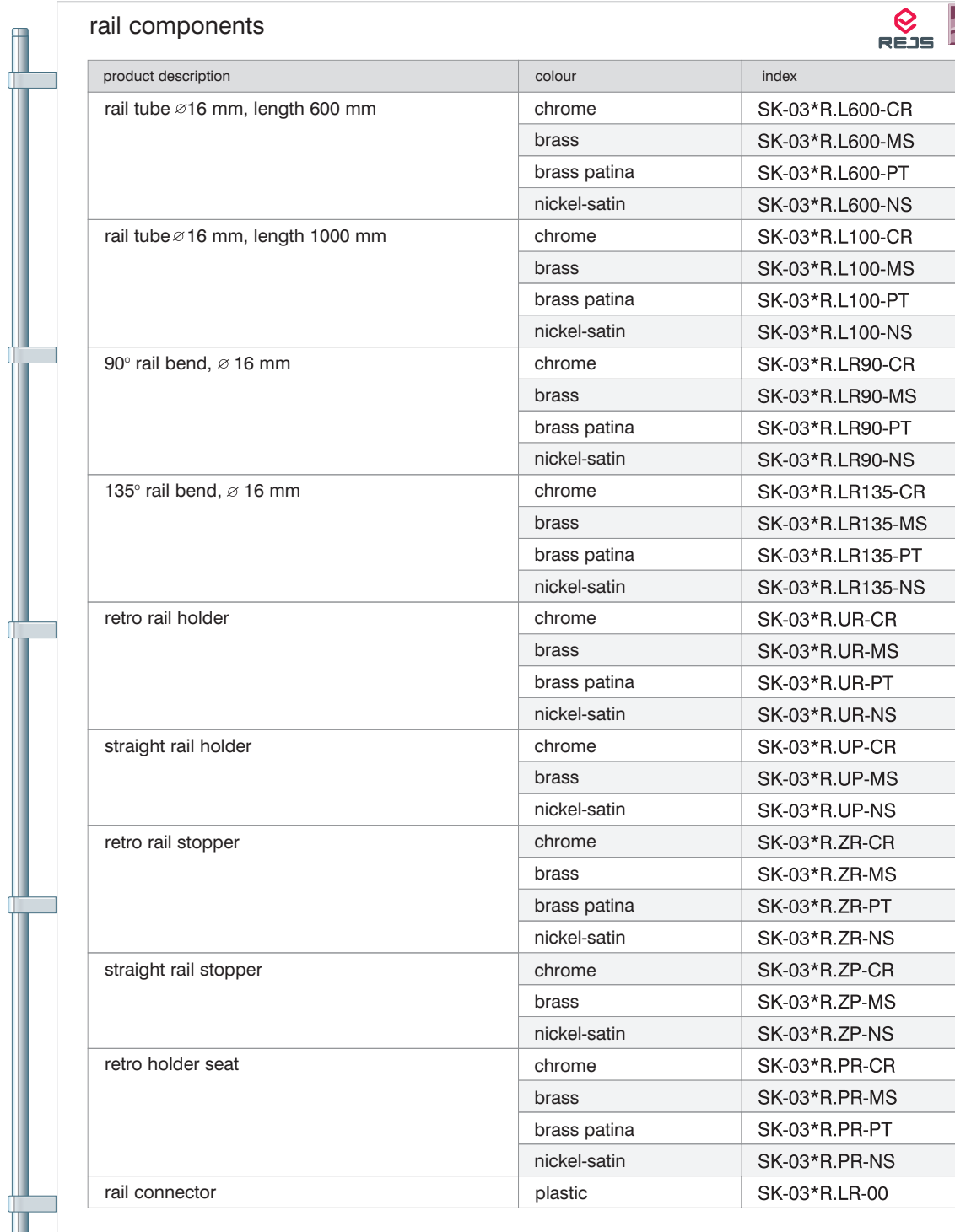

90° rail bend

rail tube

rail holder

90° rail bend

worktop mounting

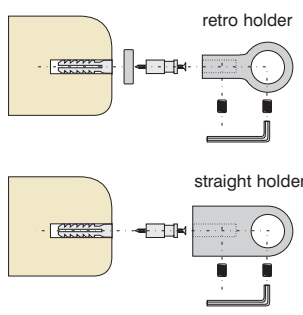

side mounting

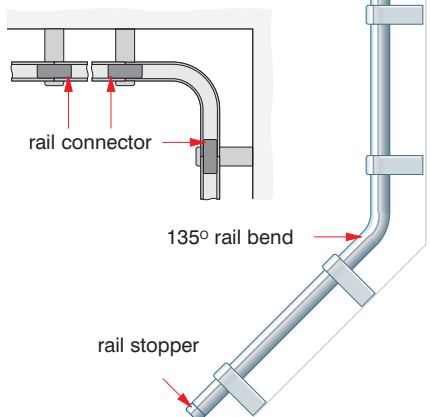
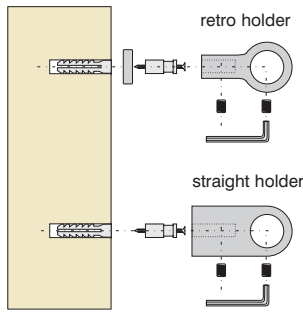

rail connector

135° rail bend

rail stopper



single wire storage basket



MINI single wire storage basket

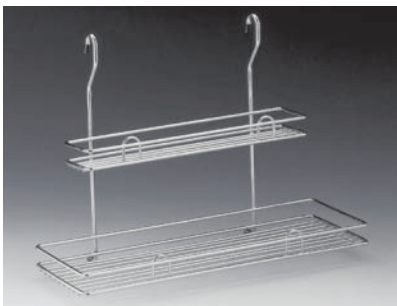

double wire storage basket



MINI double wire storage basket

wire storage baskets



product description	colour	index
single wire storage basket dimensions: 450 / 180 / 290 (width/depth/height)	chrome	SK-03*KZ.PJ-02-CR
	brass	SK-03*KZ.PJ-02-MS
	brass patina	SK-03*KZ.PJ-02-PT
	nickel-satin	SK-03*KZ.PJ-02-NS
MINI single wire storage basket dimensions: 280 / 175 / 235 (width/depth/height)	chrome	SK-03*KZ.PJ.M-14-CR
	brass	SK-03*KZ.PJ.M-14-MS
	brass patina	SK-03*KZ.PJ.M-14-PT
	nickel-satin	SK-03*KZ.PJ.M-14-NS
double wire storage basket dimensions: 450 / 190 / 335 (width/depth/height)	chrome	SK-03*KZ.PDD-04-CR
	brass	SK-03*KZ.PDD-04-MS
	brass patina	SK-03*KZ.PDD-04-PT
	nickel-satin	SK-03*KZ.PDD-04-NS
MINI double wire storage basket dimensions: 210 / 80 / 310 (width/depth/height)	chrome	SK-03*KZ.PD-03-CR
	brass	SK-03*KZ.PD-03-MS
	brass patina	SK-03*KZ.PD-03-PT
	nickel-satin	SK-03*KZ.PD-03-NS
wire storage corner basket dimensions: 270 / 300 / 235 (width/depth/height)	chrome	SK-03*KZ.N-01-CR
	brass	SK-03*KZ.N-01-MS
	brass patina	SK-03*KZ.N-01-PT
	nickel-satin	SK-03*KZ.N-01-NS
rail drainer >50< with transparent plastic tray dimensions: 555 / 260 / 260 (width/depth/height)	chrome	SK-03*KZ.OR-10-CR
	brass	SK-03*KZ.OR-10-MS
	brass patina	SK-03*KZ.OR-10-PT
	nickel-satin	SK-03*KZ.OR-10-NS



wire storage corner basket



rail drainer

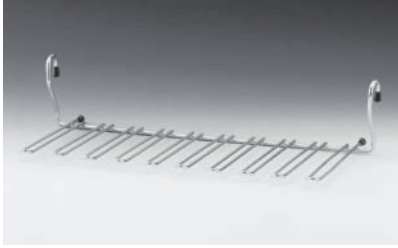

wire storage basket for glasses



wire storage basket for glasses MINI



wire storage basket for bottles



wire storage basket for bottles



wire storage basket - mug (aluminium)



wire storage basket - mug (INOX)

wire storage baskets

product description	colour	index
wire storage basket for glasses dimensions: 450 / 205 / 100 (width/depth/height)	chrome	SK-03*KZ.DK.05-CR
	brass	SK-03*KZ.DK.05-MS
	brass patina	SK-03*KZ.DK.05-PT
	nickel-satin	SK-03*KZ.DK.05-NS
wire storage basket for glasses MINI dimensions: 150 / 205 / 100 (width/depth/height)	chrome	SK-03*KZ.DK.M-15-CR
	brass	SK-03*KZ.DK.M-15-MS
	brass patina	SK-03*KZ.DK.M-15-PT
	nickel-satin	SK-03*KZ.DK.M-15-NS
wire storage basket for bottles holder for 6 bottles dimensions: 260 / 200 / 335 (width/depth/height)	chrome	SK-03*KZ.DB-07-CR
	brass	SK-03*KZ.DB-07-MS
	brass patina	SK-03*KZ.DB-07-PT
	nickel-satin	SK-03*KZ.DB-07-NS
wire storage basket for bottles holder for 3 bottles dimensions: 240 / 125 / 360 (width/depth/height)	chrome	SK-03*KZ.DBB-08-CR
	brass	SK-03*KZ.DBB-08-MS
	brass patina	SK-03*KZ.DBB-08-PT
	nickel-satin	SK-03*KZ.DBB-08-NS
wire storage basket - mug with aluminium container dimensions: 135 / 185 / 290 (width/depth/height)	chrome	SK-03*KZ.K-11-CR
	brass	SK-03*KZ.K-11-MS
	brass patina	SK-03*KZ.K-11-PT
	nickel-satin	SK-03*KZ.K-11-NS
wire storage basket - mug with INOX container dimensions: 135 / 185 / 290 (width/depth/height)	chrome	SK-03*KZ.K-19-CR
	brass	SK-03*KZ.K-19-MS
	brass patina	SK-03*KZ.K-19-PT
	nickel-satin	SK-03*KZ.K-19-NS
holder for mugs holder for 6 mugs dimensions: 370 / 80 / 330 (width/depth/height)	chrome	SK-03*KZ.UNK-21-CR
	brass	SK-03*KZ.UNK-21-MS
	brass patina	SK-03*KZ.UNK-21-PT
	nickel-satin	SK-03*KZ.UNK-21-NS
holder for dishes dimensions: 260 / 200 / 40 (width/depth/height)	chrome	SK-03*KZ.PDN-12-CR
	brass	SK-03*KZ.PDN-12-MS
	brass patina	SK-03*KZ.PDN-12-PT
	nickel-satin	SK-03*KZ.PDN-12-NS



holder for mugs

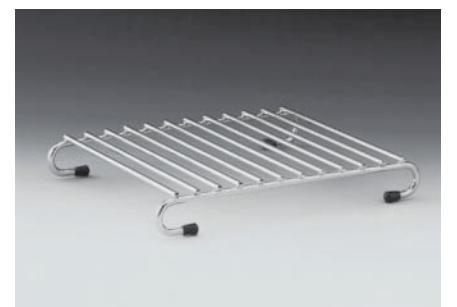

holder for dishes



wire storage basket for books



wire storage basket for paper



wire storage basket for paper laminate



holder for chopping board



lid holder



wire storage basket for spices

wire storage baskets

product description	colour	index
wire storage basket for books dimensions: 400 / 230 / 485 (width/depth/height)	chrome	SK-03*KZ.NK-09-CR
	brass	SK-03*KZ.NK-09-MS
	brass patina	SK-03*KZ.NK-09-PT
	nickel-satin	SK-03*KZ.NK-09-NS
wire storage basket for paper holder for paper towels dimensions: 325 / 180 / 190 (width/depth/height)	chrome	SK-03*KZ.DP.M-16-CR
	brass	SK-03*KZ.DP.M-16-MS
	brass patina	SK-03*KZ.DP.M-16-PT
	nickel-satin	SK-03*KZ.DP.M-16-NS
wire storage basket for paper laminate dimensions: 325 / 180 / 360 (width/depth/height)	chrome	SK-03*KZ.DP-06-CR
	brass	SK-03*KZ.DP-06-MS
	brass patina	SK-03*KZ.DP-06-PT
	nickel-satin	SK-03*KZ.DP-06-NS
holder for chopping board dimensions: 80 / 80 / 150 (width/depth/height)	chrome	SK-03*KZ.ND-17-CR
	brass	SK-03*KZ.ND-17-MS
	brass patina	SK-03*KZ.ND-17-PT
	nickel-satin	SK-03*KZ.ND-17-NS
lid holder dimensions: 100/100/290 (width/depth/height)	chrome	SK-03*KZ.UDP-13-CR
	brass	SK-03*KZ.UDP-13-MS
	brass patina	SK-03*KZ.UDP-13-PT
	nickel-satin	SK-03*KZ.UDP-13-NS
wire storage basket for spices dimensions: 210/85/195 (width/depth/height)	chrome	SK-03*KZ.NP-21-CR
	brass	SK-03*KZ.NP-21-MS
	brass patina	SK-03*KZ.NP-21-PT
	nickel-satin	SK-03*KZ.NP-21-NS
set of containers for spices material: glass, plastic container dimensions: 40/40/140 (w/d/h)	chrome	SK-03*KZ.PNP-5-CR
	nickel-satin	SK-03*KZ.PNP-5-NS
rail hook	chrome	SK-03*KZ.HR-18-CR
	brass	SK-03*KZ.HR-18-MS
	brass patina	SK-03*KZ.HR-18-PT
	nickel-satin	SK-03*KZ.HR-18-NS



set of containers for spices



rail hook

storage column systems

Storage column systems are sold in separate elements (rod, attachments, shelves and hangers are ordered individually). The virtue of this solution is matching of dimensions and column "equipment" to individual client needs.



storage column in colour brass

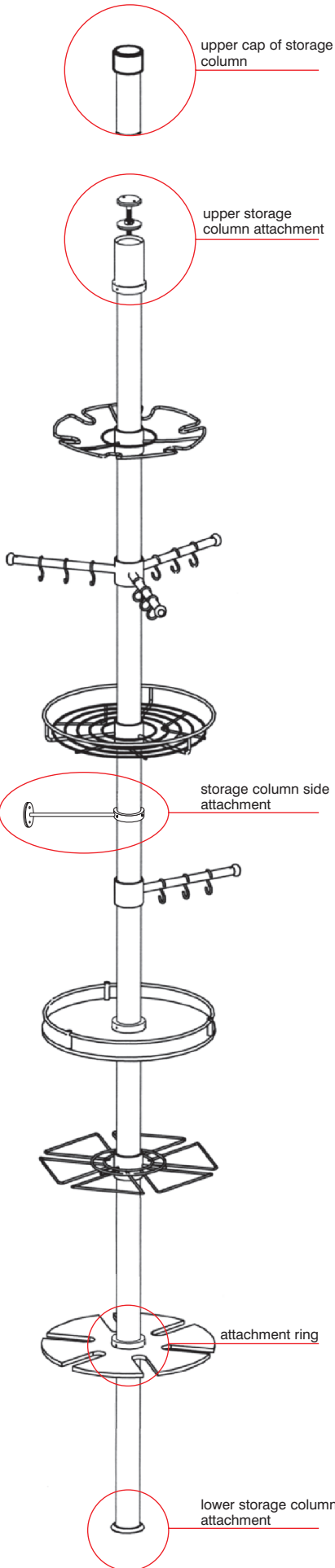

column elements



product description	colour	index
storage column rod \varnothing 50 mm sold in lengths: 250 mm, 750 mm, 1500 mm - all colours 3000 mm - only in colour chrome storage column rod is invoiced in running metres	chrome	SK-03*K.50-CR
	brass	SK-03*K.50-MS
	brass patina	SK-03*K.50-PT
	nickel-satin	SK-03*K.50-NS
lower storage column attachment	chrome	SK-03*K.MD50-CR
	brass	SK-03*K.MD50-MS
	brass patina	SK-03*K.MD50-PT
	nickel-satin	SK-03*K.MD50-NS
storage column side attachment length: 115 mm	chrome	SK-03*K.MB50-CR
	brass	SK-03*K.MB50-MS
	brass patina	SK-03*K.MB50-PT
	nickel-satin	SK-03*K.MB50-NS
upper storage column attachment	chrome	SK-03*K.MG50-CR
	brass	SK-03*K.MG50-MS
	brass patina	SK-03*K.MG50-PT
	nickel-satin	SK-03*K.MG50-NS
upper cap of storage column	chrome	SK-03*K.ZG50-CR
	brass	SK-03*K.ZG50-MS
	brass patina	SK-03*K.ZG50-PT
	nickel-satin	SK-03*K.ZG50-NS
attachment ring	chrome	SK-03*K.PM50-CR
	brass	SK-03*K.PM50-MS
	brass patina	SK-03*K.PM50-PT
	nickel-satin	SK-03*K.PM50-NS
storage column connector	plastic	SK-03*K.Z-50
column sleeves*	plastic	SK-03*K.T50



column rod



lower storage column attachment



storage column side attachment



upper storage column attachment



upper cap of storage column



attachment ring



column connector



column sleeves*

* to attach column to countertop or lighting panel

column elements

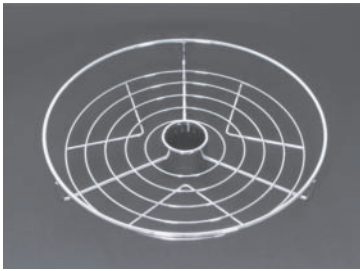

central shelf

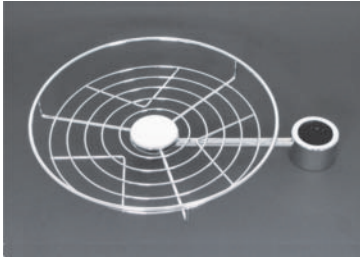

side shelf

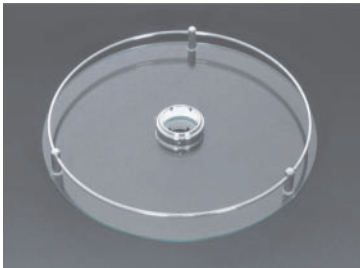

glass shelf with rail

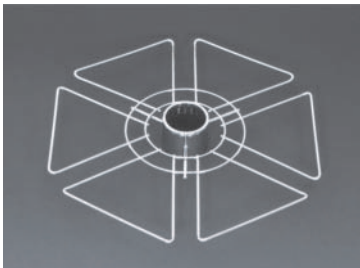

shelf for glasses type I

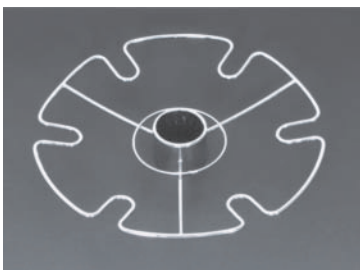

shelf for glasses type II

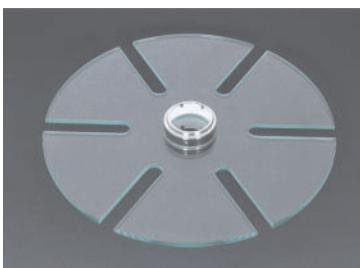

glass shelf for glasses

product description	colour	index
central shelf \varnothing 350 mm	chrome	SK-03*K.PS350-CR
	brass	SK-03*K.PS350-MS
	brass patina	SK-03*K.PS350-PT
	nickel-satin	SK-03*K.PS350-NS
central shelf \varnothing 450 mm	chrome	SK-03*K.PS450-CR
	brass	SK-03*K.PS450-MS
	brass patina	SK-03*K.PS450-PT
	nickel-satin	SK-03*K.PS450-NS
side shelf \varnothing 350 mm	chrome	SK-03*K.PB350-CR
	brass	SK-03*K.PB350-MS
	brass patina	SK-03*K.PB350-PT
	nickel-satin	SK-03*K.PB350-NS
side shelf \varnothing 450 mm	chrome	SK-03*K.PB450-CR
	brass	SK-03*K.PB450-MS
	brass patina	SK-03*K.PB450-PT
	nickel-satin	SK-03*K.PB450-NS
glass shelf with rail \varnothing 350 mm colourless, hardened glass, thickness 6 mm attachment rings in set (2 items)	chrome	SK-03*K.PSR350-CR
	brass	SK-03*K.PSR350-MS
	brass patina	SK-03*K.PSR350-PT
	nickel-satin	SK-03*K.PSR350-NS
glass shelf with rail \varnothing 450 mm colourless, hardened glass, thickness 6 mm attachment rings in set (2 items)	chrome	SK-03*K.PSR450-CR
	brass	SK-03*K.PSR450-MS
	brass patina	SK-03*K.PSR450-PT
	nickel-satin	SK-03*K.PSR450-NS
shelf for glasses type I	chrome	SK-03*K.PSK-00-CR
	brass	SK-03*K.PSK-00-MS
	brass patina	SK-03*K.PSK-00-PT
	nickel-satin	SK-03*K.PSK-00-NS
shelf for glasses type II	chrome	SK-03*K.PSK-II-CR
	brass	SK-03*K.PSK-II-MS
	brass patina	SK-03*K.PSK-II-PT
	nickel-satin	SK-03*K.PSK-II-NS
glass shelf for glasses colourless, hardened glass, thickness 6 mm attachment rings in set (2 items)	chrome	SK-03*K.PSSK-CR
	brass	SK-03*K.PSSK-MS
	brass patina	SK-03*K.PSSK-PT
	nickel-satin	SK-03*K.PSSK-NS
single arm hanger	chrome	SK-03*K.PSWJ-00-CR
	brass	SK-03*K.PSWJ-00-MS
	brass patina	SK-03*K.PSWJ-00-PT
	nickel-satin	SK-03*K.PSWJ-00-NS
triple arm hanger	chrome	SK-03*K.PSWT-00-CR
	brass	SK-03*K.PSWT-00-MS
	brass patina	SK-03*K.PSWT-00-PT
	nickel-satin	SK-03*K.PSWT-00-NS



single arm hanger



triple arm hanger



KU004 storage column

storage columns in sets

Storage columns ordered in sets are easy to mount, all the ornamental elements are on the support rod, and use of tools is only necessary for securing the column as a whole. Arrangement of shelves is chosen by the client and rods (ornamental and supporting) may be shortened.

column elements KU003:
 supporting rod, length 2000 mm, aluminium
 ornamental rod, length 815 mm
 ornamental rod, length 279 mm (5 items)
 column attachment (2 items)
 side shelf \varnothing 250 mm, steel (3 items)
 central shelf \varnothing 350 mm, steel
 attachment rings* (3 types x 4 items)
 countertop rings (2 types x 1 item)

column elements KU004:
 supporting rod, length 2000 mm, aluminium
 ornamental rod, length 800 mm
 ornamental rod, length 200 mm (6 items)
 column attachment
 triple arm hanger, steel
 side shelf \varnothing 250 mm, steel (3 items)
 central shelf \varnothing 350 mm, steel
 side attachment, length 300 mm
 column crown
 attachment rings* (3 types x 5 items)

* attachment rings serve to fasten central and side shelves and also hangers to the rod

product description	colour	index
KU003 storage column (set)	chrome	SK-SIRO-U-KU003
KU004 storage column (set)	chrome	SK-SIRO-U-KU004

KU003 storage column

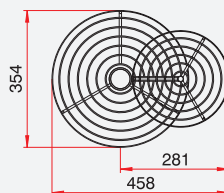
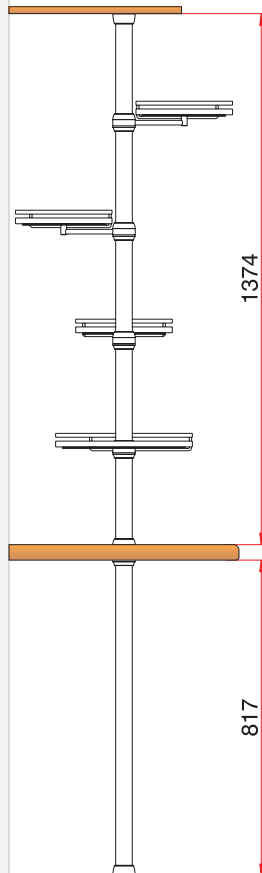

KU003

KU004 storage column

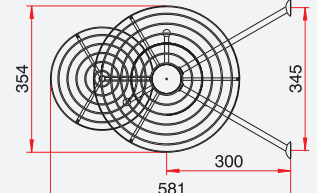
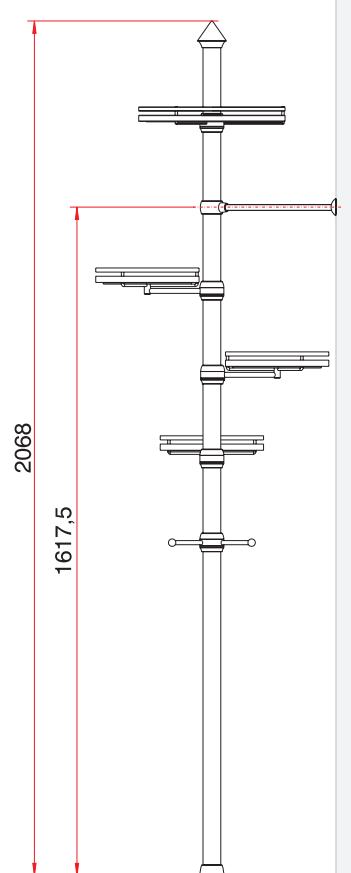

KU004



modern lifestyle

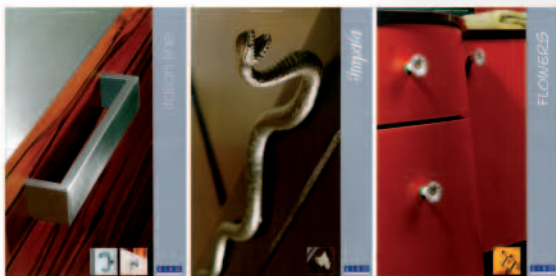

Spielfeldstrasse 12,
A-4452 Ternberg
AUSTRIA

Tel.: +43 (0)7256 6020 0
Fax: +43 (0)7256 8932

e-mail: office@siro.at
Internet: www.siro.cc

SIRO - Poland Sp. z o.o.
ul. Wernera 61/63
26-600 Radom
POLAND

Tel.: +48 (0)48 3312323
Fax: +48 (0)48 3311300

e-mail: info@siro.pl



support legs

product description	colour	index
leg \varnothing 60 mm, height 710 mm adjustment range: 710-735 mm	chrome	SK-03*N.G60X71-CR
	brass	SK-03*N.G60X71-MS
	brass patina	SK-03*N.G60X71-PT
	nickel-satin	SK-03*N.G60X71-NS
leg \varnothing 60 mm, height 820 mm adjustment range: 820-845 mm	chrome	SK-03*N.G60X82-CR
	brass	SK-03*N.G60X82-MS
	brass patina	SK-03*N.G60X82-PT
	nickel-satin	SK-03*N.G60X82-NS
leg \varnothing 60 mm, height 1100 mm adjustment range: 1100-1125 mm	chrome	SK-03*N.G60X11-CR
	brass	SK-03*N.G60X11-MS
	brass patina	SK-03*N.G60X11-PT
	nickel-satin	SK-03*N.G60X11-NS

lower cabinet legs

product description	colour	index
round ornamental leg "150"	silver	K04-INNE-BK-NOGA_O150-INN01
square ornamental leg "150"	silver	K04-INNE-BK-NOGA_P150-INN01
ordinary leg extension	black	K04-INNE-BK-PRZED_NOGI_REG-INN01



round ornamental leg "150"
adjustment range:
130-180 mm

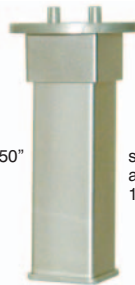

square ornamental leg "150"
adjustment range:
130-180 mm

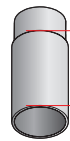

ordinary leg extension
adjustment range:
140-180 mm*

52 mm

mounting ordinary leg extension

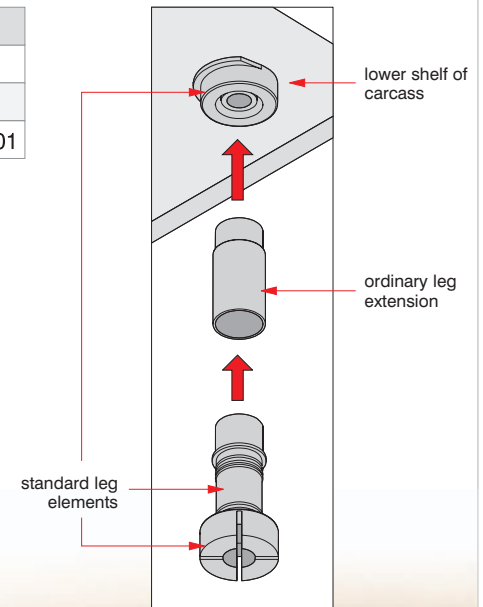

*adjustment range for leg with one extension

example of setting column, furniture legs and brackets in kitchen

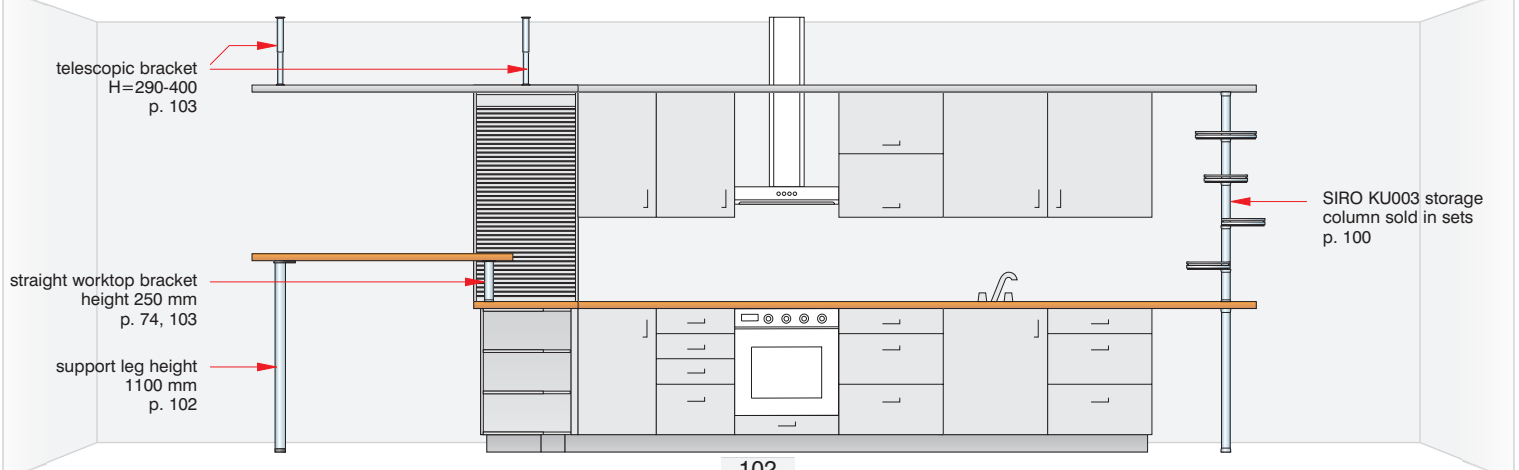



telescopic bracket

Telescopic brackets serve to secure shelves or lighting panels to ceiling. Sketch with example application is shown page 102.

product description	colour	index
telescopic bracket H=200-280 adjustment range: 200-280 mm	chrome	SK-03*K.WWR200-CR
	brass	SK-03*K.WWR200-MS
	brass patina	SK-03*K.WWR200-PT
	nickel-satin	SK-03*K.WWR200-NS
telescopic bracket H=290-400 adjustment range: 290-400 mm	chrome	SK-03*K.WWR290-CR
	brass	SK-03*K.WWR290-MS
	brass patina	SK-03*K.WWR290-PT
	nickel-satin	SK-03*K.WWR290-NS
telescopic bracket H=410-540 adjustment range: 410-540 mm	chrome	SK-03*K.WWR410-CR
	brass	SK-03*K.WWR410-MS
	brass patina	SK-03*K.WWR410-PT
	nickel-satin	SK-03*K.WWR410-NS



worktop brackets



product description	colour	index
straight worktop bracket	chrome	SK-03*K.WB50-CR
	brass	SK-03*K.WB50-MS
	brass patina	SK-03*K.WB50-PT
	nickel-satin	SK-03*K.WB50-NS
skewed worktop bracket	chrome	SK-03*K.WBS50-CR
	brass	SK-03*K.WBS50-MS
	brass patina	SK-03*K.WBS50-PT
	nickel-satin	SK-03*K.WBS50-NS

worktop brackets are also described on p. 74 and 102



shelf brackets

product description	colour	index
glass shelf bracket	chrome	SK-POLKA_WSPORNIK-CH
shelf bracket # 8-50 mm	chrome-mat	SK-POLKA_PW_WSPORNIK-CRM
shelf bracket Orient	antique	SK-POLKA_WSPORNIK_ORIENT-ANT



glass shelf bracket, adjustment range 0-20 mm



shelf bracket # 8-50 mm

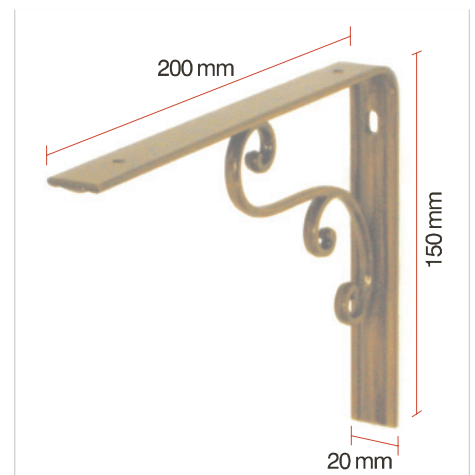

shelf bracket Orient
Orient lighting set also executed in the same style p. 106, 108



glass shelves in cabinet G-45/72-LVA

inserted glass shelves

Made from colourless glass # 5 mm, shelf edges are ground.

Glass shelves are inserted into additional equipment and should be ordered individually and inserted into cabinets in place of standard chipboard shelves.

product description	to carcasses	index
lower inserted glass shelf "45"	D-45/136, D-45/143	SK-POLKA_SZKLANA-45-DOLNA
upper inserted glass shelf "45"	G-45/72, G-45/95, T-45/121, TS(X)-45/121	SK-POLKA_SZKLANA-45-GORNA
upper inserted glass shelf "60"	G-60/72, G-60/95, T-60/121, TS(X)-60/121	SK-POLKA_SZKLANA-60-GORNA
corner inserted glass shelf	GNWU-60/72, GNWU-60/95	SK-POLKA_SZKLANA-NAROZNA

lower inserted glass shelf "45"

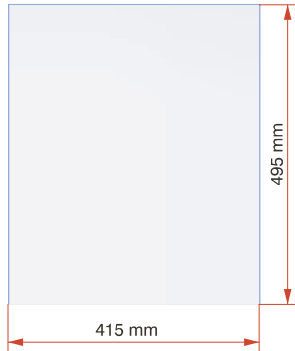

upper inserted glass shelf "45"

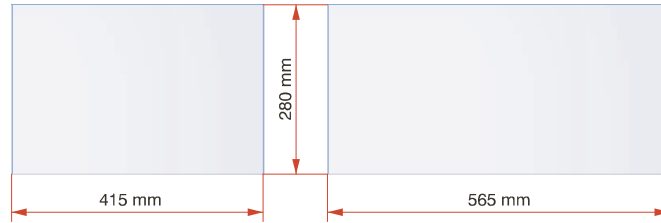

upper inserted glass shelf "60"

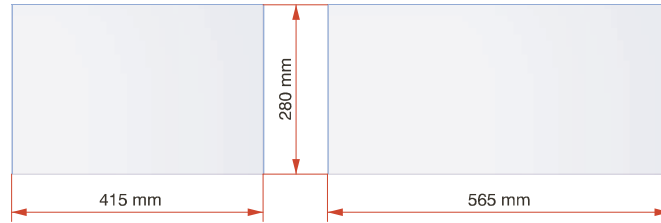

corner inserted glass shelf

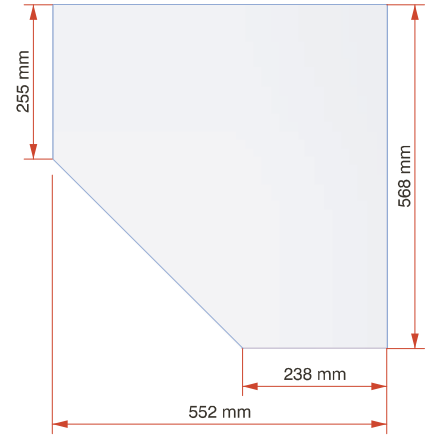

glass shelves

Made from colourless glass # 6 mm, shelf edges are ground. Special glass shelf brackets serve to secure shelves to wall (description on p. 103).

product description	index
glass shelf "45"	SK-POLKA_SZKLANA-45
glass shelf "60"	SK-POLKA_SZKLANA-60
glass shelf "90"	SK-POLKA_SZKLANA-90
glass shelf "105"	SK-POLKA_SZKLANA-105

Until stocks are exhausted glass shelves "40" and "50" are also available

glass shelf "45"



glass shelf "105"

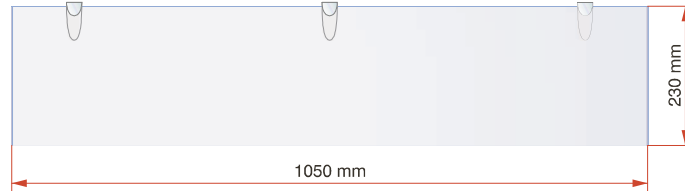

glass shelf bracket

glass shelf "60"



glass shelf "90"

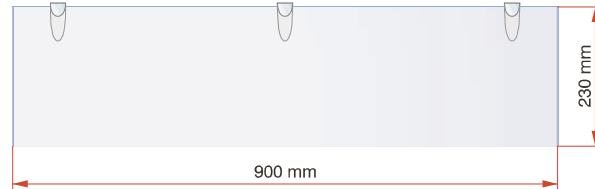

- illustrates calculation of bracket numbers of shelf of given width

Continual promotions

Short delivery times

Deliveries nationwide



EXCLUSIVE DISTRIBUTOR OF DOMESTIC EQUIPMENT IN BLACK RED WHITE CHAIN



AGD BRW



Kitchen tiling

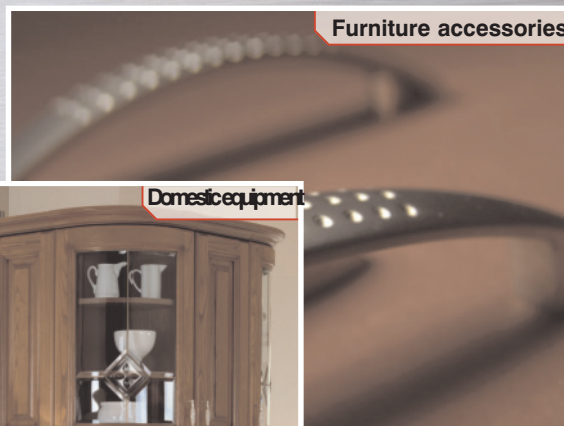

Furniture accessories



Domestic equipment



Kitchen hoods



Kitchen technology

ADVERTISEMENT



GALICJA TOMASZEK sp. z o.o.
37-100 Łańcut, ul. Cetnarskiego 35/37
tel.: +48 17 225 91 71 - domestic equipment
tel.: +48 17 225 91 70 - accessories
fax: +48 17 225 75 50
www.agdbrw.pl, email: info@agdbrw.pl

We distribute leading makes of kitchen equipment, kitchen technology and furniture accessories

WWW.AGDBRW.PL • WWW.AGDBRW.PL • WWW.AGDBRW.PL



extension arm sets

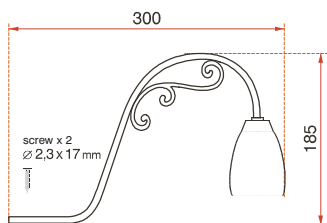

halogen 12V mounting bulb type G5, 3-35W

Orient sets

product description	colour	index
2 point ORIENT set	antique	SK-HLT-ORIENT_2PKT-ANT
3 point ORIENT set	antique	SK-HLT-ORIENT_3PKT-ANT
5 point ORIENT set	antique	SK-HLT-ORIENT_5PKT-ANT

Orient_plus sets (on order)

product description	colour	index
3+2 point set ORIENT+AIRONE M	antique	SK-HLT-ORIENT_PLUS_3_2PKT-ANT
4+3 point set ORIENT+AIRONE M	antique	SK-HLT-ORIENT_PLUS_4_3PKT-ANT
5+4 point set ORIENT+AIRONE M	antique	SK-HLT-ORIENT_PLUS_5_4PKT-ANT



lighting points in **Orient_plus** sets

bracket for Orient shelf is made in the same style, p. 103

Komo 1 sets

product description	colour	index
2 point KOMO 1 set	chrome	SK-HLT-KOMO1_2PKT-CR
3 point KOMO 1 set	chrome	SK-HLT-KOMO1_3PKT-CR
5 point KOMO 1 set	chrome	SK-HLT-KOMO1_5PKT-CR
2 point KOMO 1 set	satin	SK-HLT-KOMO1_2PKT-SA
3 point KOMO 1 set	satin	SK-HLT-KOMO1_3PKT-SA
5 point KOMO 1 set	satin	SK-HLT-KOMO1_5PKT-SA
2 point KOMO 1 set	antique	SK-HLT-KOMO1_2PKT-ANT
3 point KOMO 1 set	antique	SK-HLT-KOMO1_3PKT-ANT
5 point KOMO 1 set	antique	SK-HLT-KOMO1_5PKT-ANT

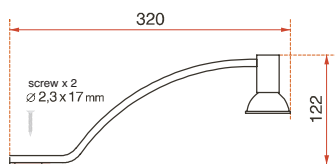

halogen 12V mounting, bulb type G5, 3-35W

* light shades for Komo 1 sets are ordered individually (description on p. 108)

Ghibli M1 sets

product description	colour	index
2 point GHIBLI M1 set	chrome	SK-HLT-GHIBLI-M1_2PKT-CR
3 point GHIBLI M1 set	chrome	SK-HLT-GHIBLI-M1_3PKT-CR
5 point GHIBLI M1 set	chrome	SK-HLT-GHIBLI-M1_5PKT-CR
2 point GHIBLI M1 set	satin	SK-HLT-GHIBLI-M1_2PKT-SA
3 point GHIBLI M1 set	satin	SK-HLT-GHIBLI-M1_3PKT-SA
5 point GHIBLI M1 set	satin	SK-HLT-GHIBLI-M1_5PKT-SA
2 point GHIBLI M1 set	antique	SK-HLT-GHIBLI-M1_2PKT-ANT
3 point GHIBLI M1 set	antique	SK-HLT-GHIBLI-M1_3PKT-ANT
5 point GHIBLI M1 set	antique	SK-HLT-GHIBLI-M1_5PKT-ANT

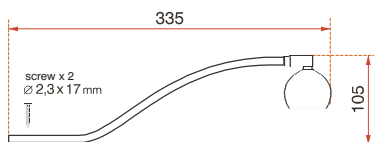

halogen 12V mounting with movable head, bulb type G5, 3-35W

Duet Extra sets (on order)

product description	colour	index
2 point Duet extra set	chrome	SK-HLT-DUET_EXTRA_2PKT-CR
3 point Duet extra set	chrome	SK-HLT-DUET_EXTRA_3PKT-CR
5 point Duet extra set	chrome	SK-HLT-DUET_EXTRA_5PKT-CR
2 point Duet extra set	satin	SK-HLT-DUET_EXTRA_2PKT-SA
3 point Duet extra set	satin	SK-HLT-DUET_EXTRA_3PKT-SA
5 point Duet extra set	satin	SK-HLT-DUET_EXTRA_5PKT-SA



halogen mounting on extension arm, halogen 12V brace type G4-10W

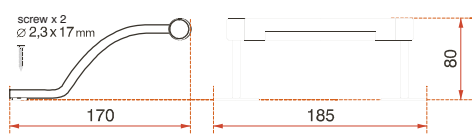

halogen eyelet

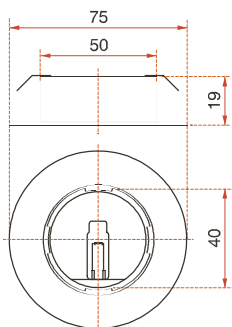

halogen 12V mounting, pressed, bulb type G4-20W

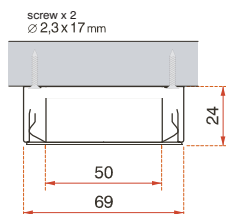

halogen 12V mounting, screwed, bulb type G4-20W

S-2000 H sets

product description	colour	index
2 point S-2000 H set	chrome	SK-HLT-S2000H_2PKT-CR
3 point S-2000 H set	chrome	SK-HLT-S2000H_3PKT-CR
5 point S-2000 H set	chrome	SK-HLT-S2000H_5PKT-CR
2 point S-2000 H set	brushed steel	SK-HLT-S2000H_2PKT-STD
3 point S-2000 H set	brushed steel	SK-HLT-S2000H_3PKT-STD
5 point S-2000 H set	brushed steel	SK-HLT-S2000H_5PKT-STD
2 point S-2000 H set	satin	SK-HLT-S2000H_2PKT-SA
3 point S-2000 H set	satin	SK-HLT-S2000H_3PKT-SA
5 point S-2000 H set	satin	SK-HLT-S2000H_5PKT-SA
2 point S-2000 H set	gold	SK-HLT-S2000H_2PKT-ZL
3 point S-2000 H set	gold	SK-HLT-S2000H_3PKT-ZL
5 point S-2000 H set	gold	SK-HLT-S2000H_5PKT-ZL
2 point S-2000 H set	antique	SK-HLT-S2000H_2PKT-ANT
3 point S-2000 H set	antique	SK-HLT-S2000H_3PKT-ANT
5 point S-2000 H set	antique	SK-HLT-S2000H_5PKT-ANT

S-2000 H with spacer sets

product description	colour	index
2 point S-2000 H set with spacer	chrome	SK-HLT-S2000H_Z_DST_2PKT-CR
3 point S-2000 H set with spacer	chrome	SK-HLT-S2000H_Z_DST_3PKT-CR
5 point S-2000 H set with spacer	chrome	SK-HLT-S2000H_Z_DST_5PKT-CR
2 point S-2000 H set with spacer	brushed steel	SK-HLT-S2000H_Z_DST_2PKT-STD
3 point S-2000 H set with spacer	brushed steel	SK-HLT-S2000H_Z_DST_3PKT-STD
5 point S-2000 H set with spacer	brushed steel	SK-HLT-S2000H_Z_DST_5PKT-STD
2 point S-2000 H set with spacer	satin	SK-HLT-S2000H_Z_DST_2PKT-SA
3 point S-2000 H set with spacer	satin	SK-HLT-S2000H_Z_DST_3PKT-SA
5 point S-2000 H set with spacer	satin	SK-HLT-S2000H_Z_DST_5PKT-SA
2 point S-2000 H set with spacer	gold	SK-HLT-S2000H_Z_DST_2PKT-ZL
3 point S-2000 H set with spacer	gold	SK-HLT-S2000H_Z_DST_3PKT-ZL
5 point S-2000 H set with spacer	gold	SK-HLT-S2000H_Z_DST_5PKT-ZL
2 point S-2000 H set with spacer	antique	SK-HLT-S2000H_Z_DST_2PKT-ANT
3 point S-2000 H set with spacer	antique	SK-HLT-S2000H_Z_DST_3PKT-ANT
5 point S-2000 H set with spacer	antique	SK-HLT-S2000H_Z_DST_5PKT-ANT

Neo sets

product description	colour	index
2 point S-2000 H set	chrome	SK-HLT-NEO_2PKT-CR
3 point S-2000 H set	chrome	SK-HLT-NEO_3PKT-CR
5 point S-2000 H set	chrome	SK-HLT-NEO_5PKT-CR
2 point S-2000 H set	brushed steel	SK-HLT-NEO_2PKT-STD
3 point S-2000 H set	brushed steel	SK-HLT-NEO_3PKT-STD
5 point S-2000 H set	brushed steel	SK-HLT-NEO_5PKT-STD
2 point S-2000 H set	satin	SK-HLT-NEO_2PKT-SA
3 point S-2000 H set	satin	SK-HLT-NEO_3PKT-SA
5 point S-2000 H set	satin	SK-HLT-NEO_5PKT-SA
2 point S-2000 H set	antique	SK-HLT-NEO_2PKT-ANT
3 point S-2000 H set	antique	SK-HLT-NEO_3PKT-ANT
5 point S-2000 H set	antique	SK-HLT-NEO_5PKT-ANT

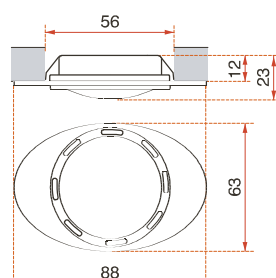

halogen 12V mounting pressed, bulb type G4-20W

under cabinet sets

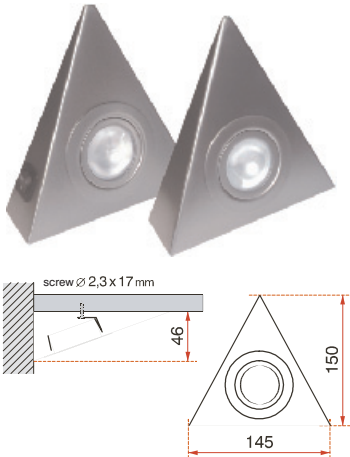

halogen 12V mounting screw mounted under cabinet, with swinging switch, bulb type G4-20W

Airone M sets

product description	colour	index
2 point AIRONE M set	chrome	SK-HLT-AIRONE-M_2PKTW-CR
3 point AIRONE M set	chrome	SK-HLT-AIRONE-M_3PKTW-CR
5 point AIRONE M set	chrome	SK-HLT-AIRONE-M_5PKTW-CR
2 point AIRONE M set	brushed steel	SK-HLT-AIRONE-M_2PKTW-STD
3 point AIRONE M set	brushed steel	SK-HLT-AIRONE-M_3PKTW-STD
5 point AIRONE M set	brushed steel	SK-HLT-AIRONE-M_5PKTW-STD
2 point AIRONE M set	satin	SK-HLT-AIRONE-M_2PKTW-SA
3 point AIRONE M set	satin	SK-HLT-AIRONE-M_3PKTW-SA
5 point AIRONE M set	satin	SK-HLT-AIRONE-M_5PKTW-SA
2 point AIRONE M set	antique	SK-HLT-AIRONE-M_2PKTW-ANT
3 point AIRONE M set	antique	SK-HLT-AIRONE-M_3PKTW-ANT
5 point AIRONE M set	antique	SK-HLT-AIRONE-M_5PKTW-ANT



Airone M lighting mountings in antique colour are also offered in sets with Orient extension arm sets; one may also buy Orient brackets for these sets for shelves



Orient_plus sets p. 106; shelf bracket Orient p. 103

Airone M mounting



Airone M under cabinet mountings with socket and switch have the same dimensions as Airone M halogen mountings

product description	colour	index
AIRONE M under cabinet mounting with 230 V socket	chrome / white	SK-HLT-AIRONE-M_GN-CR
	brushed steel/graphite	SK-HLT-AIRONE-M_GN-STD
	satin / white	SK-HLT-AIRONE-M_GN-SA
	antique / graphite	SK-HLT-AIRONE-M_GN-ANT
AIRONE M under cabinet mounting with 230 V switch	chrome / white	SK-HLT-AIRONE-M_WYL-CR
	brushed steel/graphite	SK-HLT-AIRONE-M_WYL-STD
	satin / white	SK-HLT-AIRONE-M_WYL-SA
	antique / graphite	SK-HLT-AIRONE-M_WYL-ANT

lighting set accessories



light shades for Komo 1 sets

product description	colour	index
glass lamp shades	white	SK-HLT-KLOSZ_SZKL-BI
	blue	SK-HLT-KLOSZ_SZKL-NI
	green	SK-HLT-KLOSZ_SZKL-ZI



Komo 1 sets are shown on p. 106

other accessories

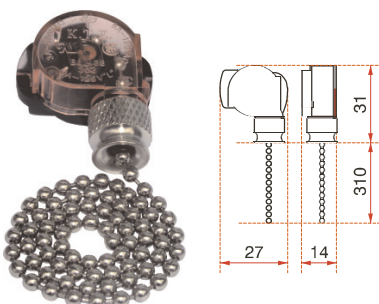

dielectric switch

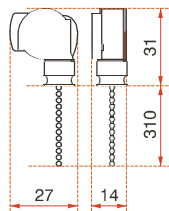

product description	colour	index
dielectric switch	chrome	SK-HLT-WYL_KORALIK-CR
	gold	SK-HLT-WYL_KORALIK-ZL
extension connector, length 1 m		SK-HLT-PRZED_KONEKTOR-00



extension connector

Extension connector application:

- extension lead connecting lighting point with connector wiring,
- connection of under cabinet mounting with transformer placed on upper cabinet.

lighting sets characteristics



Extension arm lamps (**Orient, Komo 1, Ghibli M1, Duet Extra**), halogen eyelets (**S-2000 H, S-2000 H with spacer, Neo**) and under cabinet lamps (**Airone M**) are sold in 2, 3 or 5 point sets. Mixed sets are also offered **Orient plus** (extension arm lamp Orient + under cabinet lamp Airone M)

A set is composed of:

- lighting points,
- transformer (2 transformers*),
- wiring with connectors,
- power supply lead 2 rm (4 rm*).

Orient plus sets have two separate switches, in **Airone M** sets switch is on housing of lighting point. In remaining sets switch is placed on power supply lead. One may also order a dielectric switch.

Wiring with connectors enables quick connection of particular lighting points (without the use of tools). Maximum distance between points is 105 cm.

Transformator PLUS** has protection against: short-circuits, over-voltage, overloading, which has an effect on user safety and substantially extends equipment life.

colours



available sets p. 106-108

* concerns Orient Plus sets
** until stocks are exhausted lighting sets shall be sold with "ordinary" transformer

Selene 1 fluorescent mounting



fluorescent mounting SELENE 13W

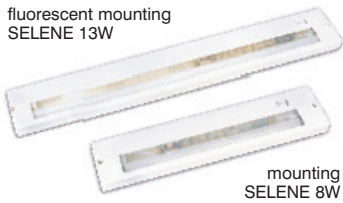

mounting SELENE 8W

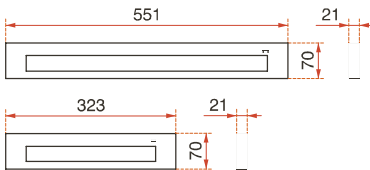

product description	colour	index
SELENE 8W mounting, length 335 mm	white	SK-HLT-SELENE_8W-BI
SELENE 13W mounting, length 550 mm	white	SK-HLT-SELENE_13W-BI
connecting cable, length 150 mm	white	SK-HLT-SELENE_KABEL-BI

Fluorescent mountings may be mounted singly or in series (5 units maximum). Connection may be made with the aid of a special cube attached to each fluorescent unit, or use connecting cable (colour white, length 150 mm). Cable should be ordered separately.



cable connecting fluorescent mounting

planning kitchen lighting

Often in kitchens the only light source is a ceiling centre lamp. It is an impractical solution, equally for a person working on a worktop, as for someone sitting at the table, shading their own light (sketch 1).

A better solution is the use of extension arm sets, which illuminate a greater part of the work surface (sketch 2).

The best lighting of the working area is ensured by under cabinet lighting (sketch 3 and 4).

The upper lamp may be placed centrally over the table.

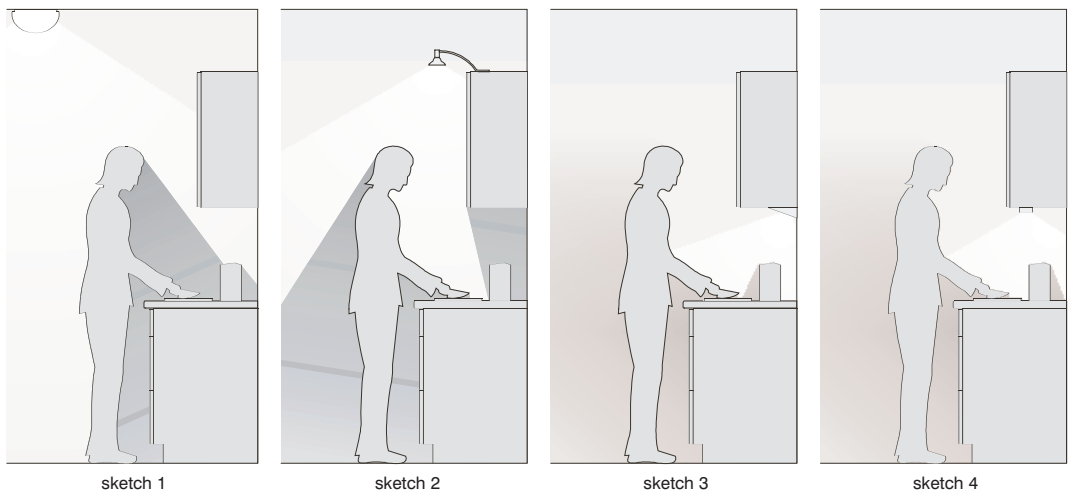

BLUMOTION silent door closing system



BLUMOTION for doors

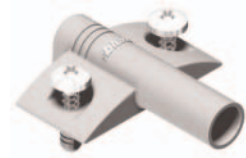

cross mounting plate EXPANDO



SPAX double mounting plate

product description	index
BLUMOTION for doors	SK-970.1002-BLUMOTION
EXPANDO cross mounting plate (with wheel)	SK-970.15E1-PLYTKA_PJ
SPAX double mounting plate	SK-970.2501-PLYTKA_PD
drilling pattern	SK-65.5000-WZORNIK

BLUMOTION for doors absorbs door closing movement irrespective of the force with which they are closed.

BLUMOTION can be mounted by inserting it in the carcass. The mounting plate may also be used by fixing it to the side of the cabinet in a place previously drilled for the hinge guide (unit with 1 door) or to the upper crown of the carcass (unit with 2 doors).

Maximum distance of the shock absorber from the hinge is 600 mm. In the case of large or unstable doors (wooden frames, VA3 frames) it may be necessary to mount a second BLUMOTION shock absorber.

The drilling guide (picture opposite) is recommended as equipment for the installation team. With its aid one may easily drill the holes precisely for the BLUMOTION set into the carcass or under mounting plate (see sketch below).

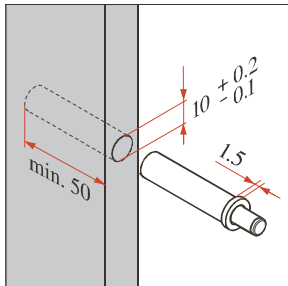

BLUMOTION for doors carcass plate mounting method

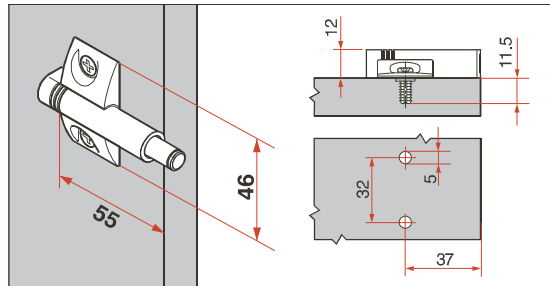

EXPANDO cross plate mounting method

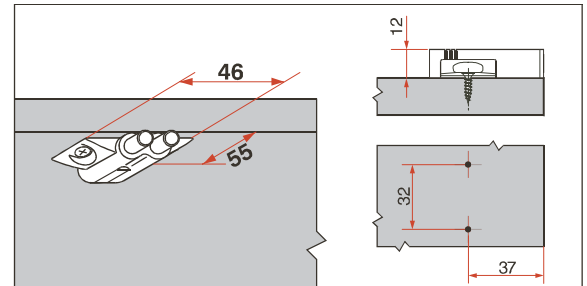

SPAX double plate mounting method

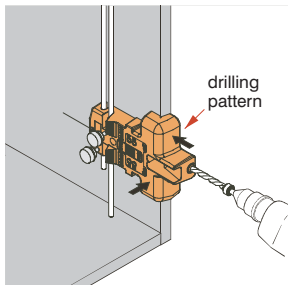

Drilling carcass under BLUMOTION insertion

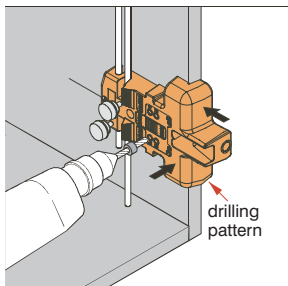

Drilling carcass under mounting plate (both types)

Positioning BLUMOTION shock absorber

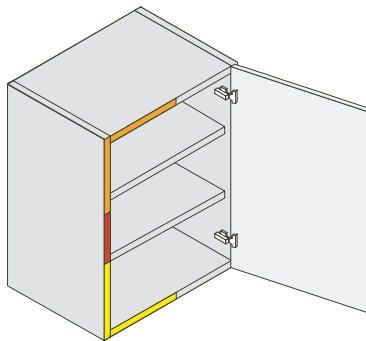

- optimal position
- proper position
- permissible position

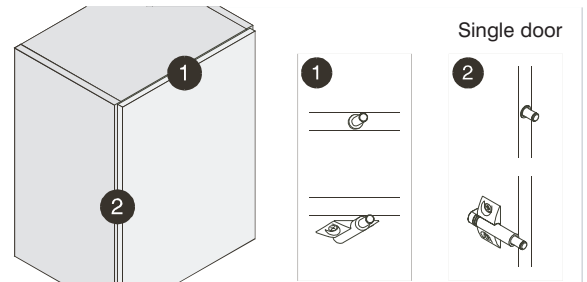

Single door

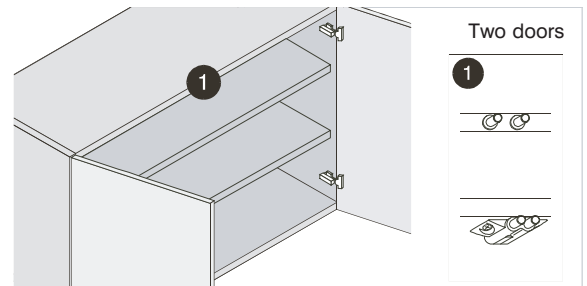

Two doors

hanging strip

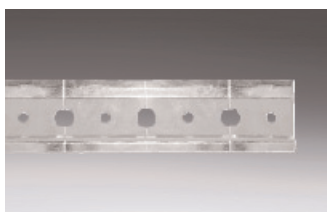

product description	index
hanging strip, length 2000 mm	SK-03*OM.LM2000

Longer strip enables faster and more exact mounting and regulation of upper cabinets (attachment for hanging plates is standard for upper cabinet carcass packs).

suspended containers



product description	index
suspended containers, set	SK-ZB-POJ_PDW_KPL3

Suspended containers are made from plastic coloured bottle green and are sold in sets (3 containers + securing element), which may be joined in a long module.

set dimensions (length/depth/height): 297 / 175 / 130 mm.

container dimensions (length/depth/height): 89 / 167 / 125 mm.

hinge hole cover



product description	index
hinge hole cover, \varnothing 35 mm, colour ash	SK-PP-ZASLEPKA_FI35

In some types of refrigerators the furniture hinges are not adaptable for housing in cabinets (kitchen cabinet doors are fixed directly to refrigerator doors). Place hinge hole covers in the openings in the door.

Please note: in the case of kitchens from Royal and CAPITAL groups, and Melos doors (Classic Line) drilling under hinge seat boxes is done after order made. If the client orders that type of refrigerator, it is enough to write in the order that the cabinet doors for the refrigerator are not drilled.

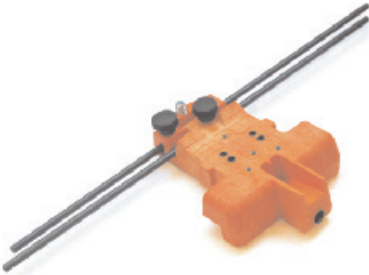

drilling pattern



enables precise drilling of holes for BLUMOTION shock absorbers inset into carcass and under mounting plate (index, and sketches show drilling method on opposite page)

repair kit for retouching damage to wooden surfaces and plastic



System BRW service case



- hard wax BRW * (Ko 141) 10 sticks of 8 cm
- soft wax BRW * (Ko 140) 10 sticks of 8 cm
- wax for scratches (Ko 130) 10 sticks of 8 cm
- pen Kanten Fix PLUS BRW * (Ko243) 7 items
- pen COLOR (Ko 210) 2 items
- plastic spatula (Ko 161) 1 item
- wax melting device (Ko 439) 1 item
- scraper (Ko 406) 1 item
- polishing fabric (Ko 609 100) 1 item
- cleaning fabric (Ko 609 103) 1 item
- steel wool for cleaning - 25g (Ko 413) 1 item
- knitted wipers (Ko 422) 5 items
- lacquer protecting retouch (Ko 338) 1 item
- Furniture Cure - 200 ml (Ko 542) 1 item
- felt block (Ko 419) 1 item

Orders for service cases and / or particular products should be placed with the firm Ottimo:

P.P.H.U. OTTIMO
ul. Młyńska 27
42-700 Lubliniec
Poland

tel.: +48 34 351 12 50
fax: +48 34 353 06 50

internet: www.ottimo.pl
e-mail: biuro.jp@ottimo.pl

While placing orders it is possible to modify the colours and composition of case.

Apart from the indicated kits one may also order SYSTAINER* with selected repair substances.

Ottimo provides free training to repair kit users.

* - SYSTAINER is a module system tool box created by Festo Tooltechnic (FESTOOL).

BRW KO 119 service case



- hard wax BRW * (Ko 141) 10 sticks of 8 cm
- wax for scratches (Ko 130) 10 sticks of 8 cm
- pen Kanten Fix PLUS BRW * (Ko243) 4 items
- retouch stick (Ko 205) 1 item.
- plastic spatula (Ko 161) 1 item
- wax melting device (Ko 439) 1 item
- scraper (Ko 406) 1 item
- polishing fabric (Ko 609 100) 1 item
- cleaning fabric (Ko 609 103) 1 item
- steel wool for cleaning - 25g (Ko 413) 1 item
- knitted wipers (Ko 422) 5 items
- lacquer protecting retouch (Ko 338) 1 item
- Furniture Cure - 200 ml (Ko 542) 1 item
- felt block (Ko 419) 1 item

* marked products are available in Black Red White colours (including for SPK and NIKA kitchens),



selection of materials to retouch Black Red White colours



repair materials to retouch doors

group	door	index	pen Kanten Fix Plus Ko 243	pen Color Ko 210	hard wax Plus Ko 143	soft wax Ko 140	wax for scratches Ko 130
Royal	[11] Strategio XI Mądry	BRW 17	*	*	**	**	**
	[14] Insignata XIV Dumna	BRW 30	*	*	**	**	*
	[15] Artycja XV Dobra	BRW 16	*	*	**	*	*
	[16] Diadema XVI Piękna	BRW 21	*	*	**	*	*
	[22] Imperor XXII Łaskawy	BRW 18	*	*	**	*	*
	[25] Troniusz XXV Sprawiedliwy	BRW 19	*	*	***	**	**
CAPITAL	34 th Avenue	BRW 33	*	*	**	**	**
	35 th Avenue	BRW 32	*	*	*	*	*
	36 th Avenue	BRW 31	*	*	**	**	**
Sentima	[3]P Trzy Życzenia Patyna	BRW 45	*	*	**	*	**
	[4] Cztery Pory Roku	BRW					
	[7] Siódme Niebo	BRW 46	*	*	*	**	*
	[9] Dziewiąta Symfonia	BRW 43	*	*	**	*	*
TRAFFIC	[12]P Tuzin Róż Patyna	BRW 44	*	*	*	*	**
	41 st Milk Street	BRW 22	*		*	*	
	46 th Sesame Street	BRW 23	**	*	**	**	**
	51 st Vanilla Street	BRW 24	*		*	*	
	56 th Cherry Street	BRW 25	*	*	**	**	*
	61 st Pudding Street	BRW 26	*		*	*	
	71 st Street	BRW 27	*		*	*	
	72 nd Street	BRW 28	*		*	*	
	74 th Street	BRW 59	*	*	**	**	**
	75 th Street	BRW 29	*	*	*	*	**
	76 th Street	BRW 30	*	*	***	**	**
Classic Line	Dekorado Calvados Patina	BRW 64	*	*	**	**	**
	Ledo Italian Cherry Patina	BRW 63	*	*	***	***	**
	Melos Orange Birch	BRW 42	*	*	*	**	*
	Rosa Antique Cherry Patina	BRW 41	*	*	**	*	*
Modern Line	Diona / Hedar Milan Oak	BRW 35	*	*	**	**	**
	Diona / Hedar Wenge	BRW 34	*	*	**	**	**
	Diona / Hedar Golden Cherry	BRW 36	*	*	*	**	**
	Telesto Milan Oak	BRW 38	*	*	*	**	**
	Telesto Maple Nida	BRW 40	*	*	**	**	*
	Telesto Wenge	BRW 37	*	*	**	**	**
	Telesto Golden Cherry	BRW 39	*	*	*	*	**

repair materials to retouch carcasses and panels

carcass / panel	index	pen Kanten Fix Plus Ko 243	pen Color Ko 210	hard wax Plus Ko 143	soft wax Ko 140	wax for scratches Ko 130
Beige (BE)	BRW 14	*		*	*	
White (BI)	BRW 6	*		*	*	*
Beech (BU)	BRW 1	*	*	**	*	**
Milan Oak (DM)	BRW 12	*	*	**	*	**
Windsor Oak (DW)	BRW 3	*	*	*	**	**
Chestnut (KA)	BRW 4	*	*	*	**	**
Medium Chestnut (KAS)	BRW 5	*	*	**	**	*
Nida Maple (KLN)	BRW 10	*	*	**	**	*
San Alder (OLS)	BRW 2	*	*	**	*	**
Grey (SZ)	BRW 13	*		**	*	
Wenge (WE)	BRW 11	*	*	**	**	**
Elba Cherry (WISE)	BRW 8	*	*	**	**	**
Electra Cherry (WIEL)	BRW 7	*	*	**	*	**
Portofino Cherry (WISP)	BRW 9	*	*	**	**	**
window	BRW 15	*		**	*	

* - means that given repair material selected for given colour

/ - means that given repair material is selected in two / three shades of given colour

To order chosen repair material give its name and colour code. Example:
Kanten Fix Plus (Ko 243) BRW 23 or **Ko 243 BRW 23**

Place orders for repair materials with Ottimo (address on p. 111).

FESTOOL tools
essential for furniture installation
recommended by BLACK RED WHITE

www.festool.pl



FESTOOL



SCREWDRIVER C 12



**FRET-SAW
PS 300 EQ**



**SYMMETRIC
SYM 70 E**



**SAWING MACHINE
TS 55 EBQ**



PLANE EHL 65 E



**ROUTER
OF 1400 EBQ**



**VACUUM CLEANER
CTL 33 E**



SYSTAINER



TTS Tooltechnic Systems AG & Co. KG
 Wertstraße 20
 D-73240 Wendlingen

represented by:

Tooltechnic Systems (Poland) Sp. z o.o.
 ul. Mszczonowska 7
 Janki k. Warszawy
 05-090 Raszyn, POLAND
 tel. (+48 22) 711 41 61 ÷ 63
 fax (+48 22) 720 11 00 ÷ 01
 email: tooltechnic_poland@festo.com

Service:
 tel. (+48 22) 711 41 61
 fax (+48 22) 720 11 00

Technical advice:
 tel. (+48 22) 711 41 68

ADVERTISEMENT



classic hoods, width 90 cm



Amata 90

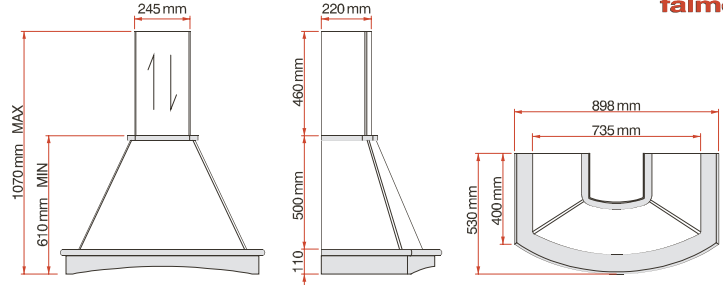

available colour range



Cream / Honey Alder*

[15] ARTYCJA XV DOBRA



Cream / Orange*

Melos Orange Birch



Cream / Morello Cherry*

[14] INSYGNATA XIV DUMNA



Cream / Dark Nut*

[16] DIADEMA XVI PIĘKNA

* colouring of wooden hood elements may vary slightly from colouring of kitchen doors

hood technical data
on opposite side



Demeter 90

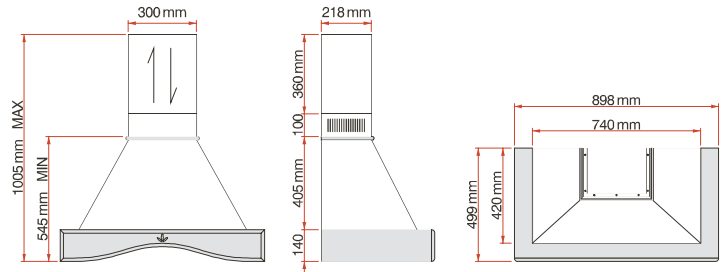

available colour range



Cream / Walnut*

[22] IMPEROR XXII LASKAWY

* colouring of wooden hood elements may vary slightly from colouring of kitchen doors

hood technical data
on opposite side



Ismena 90

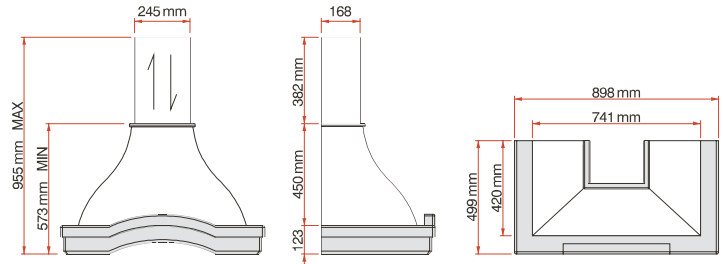

available colour range



Cream / Morello Cherry*

[14] INSYGNATA XIV DUMNA

* colouring of wooden hood elements may vary slightly from colouring of kitchen doors

hood technical data
on opposite side



Latona 90

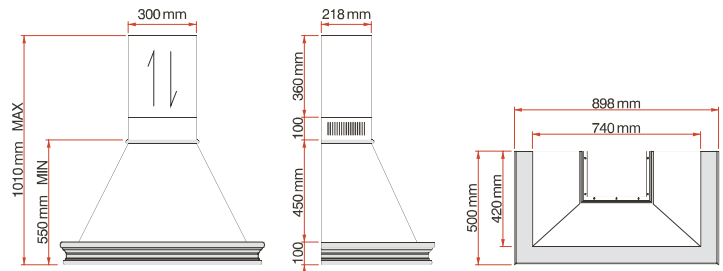

available colour range



Cream / Chestnut*

[25] TRONIUSZ XXV SPRAWIEDLIWY

* colouring of wooden hood elements may vary slightly from colouring of kitchen doors

hood technical data
on opposite side

classic hoods, width 90 cm



Nemezis 90

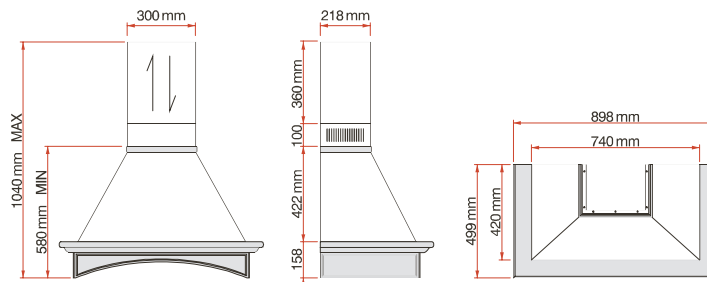

available colour range

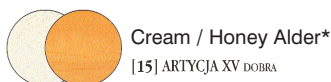

* colouring of wooden hood elements may vary slightly from colouring of kitchen doors

hood technical data at the bottom of the page



Venus 90

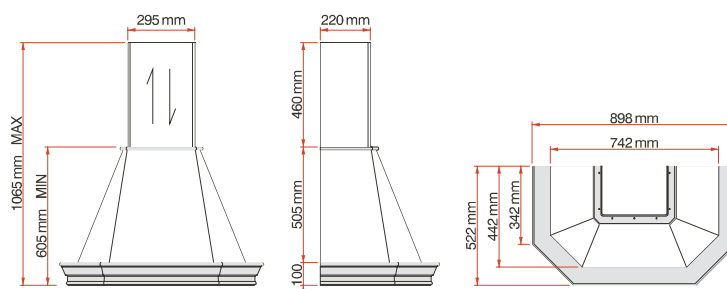

available colour range



* colouring of wooden hood elements may vary slightly from colouring of kitchen doors

hood technical data at the bottom of the page

technical characteristics of classic hoods width 90 cm



technical details	classic hoods width 90 cm
ranges of speed	1 2 3
productivity (noisiness) at particular phases	150 m ³ /h (44 dbA) 300 m ³ /h (48 dbA) 450 m ³ /h (55 dbA)
application	extraction / recirculation
anti fat filter (metal)	x 2
anti smell filter* (carbon)	type K186 x 2
outlet diameter	120 mm
lighting	2 x 25 W (max. 2 x 40W - option)

* anti smell filters (carbon) are applied if hood has a re-circulation function

for kitchen	hood	colour	index
[11] STRATEGIO XI MADRY	Venus 90	Cream / Light Chestnut	AG-FAL-VENUS_90_KAJ
[22] IMPEROR XXII LASKAWY	Demeter 90	Cream / Walnut	AG-FAL-DEMETER_90_OW
[25] TRONIUSZ XXV SPRAWIEDLIWY	Latona 90	Cream / Chestnut	AG-FAL-LATONA_90_KA
[14] INSYGNATA XIV DUMNA	Amata 90	Cream / Morello Cherry	AG-FAL-AMATA_90_WIS
	Ismena 90	Cream / Morello Cherry	AG-FAL-ISMENA_90_WIS
[15] ARTYCJA XV DOBRA	Amata 90	Cream / Honey Alder	AG-FAL-AMATA_90_OM
	Nemezis 90	Cream / Honey Alder	AG-FAL-NEMEZIS_90_OM
[16] DIADEMA XVI PIĘKNA	Amata 90	Cream / Dark Nut	AG-FAL-AMATA_90_OC
Melos Orange Birch	Amata 90	Cream / Orange	AG-FAL-AMATA_90_ORN



carbon filters type K186

carbon filter (anti smell)

product description	index
carbon filter type K186	AG-FAL-K186-FILTR



classic hoods, width 90 cm



Amata 60

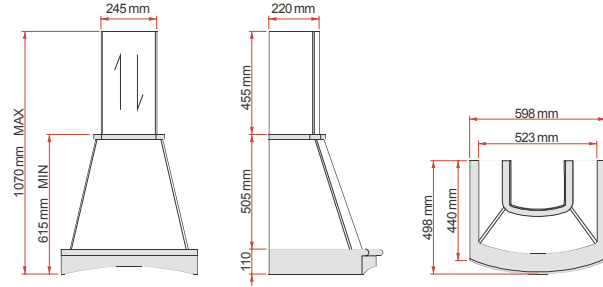

available colour ranges



hood technical data
on opposite side



Demeter 60

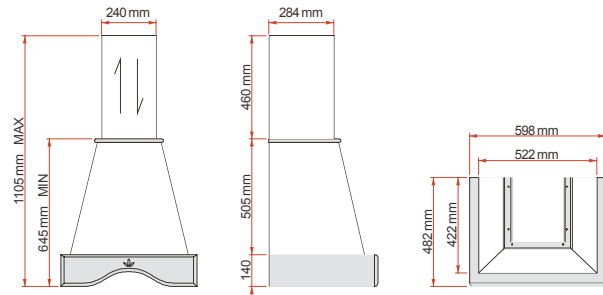

available colour range



* colouring of wooden hood elements may vary slightly from colouring of kitchen doors

hood technical data
on opposite side



Latona 60

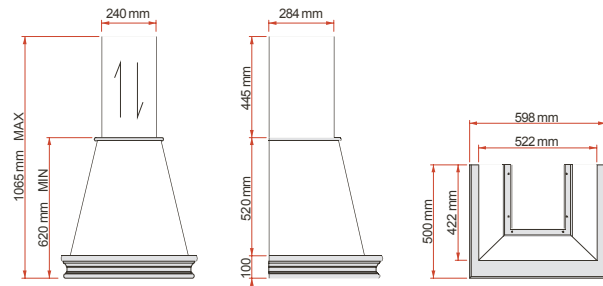

available colour range



* colouring of wooden hood elements may vary slightly from colouring of kitchen doors

hood technical data
on opposite side



Venus 60

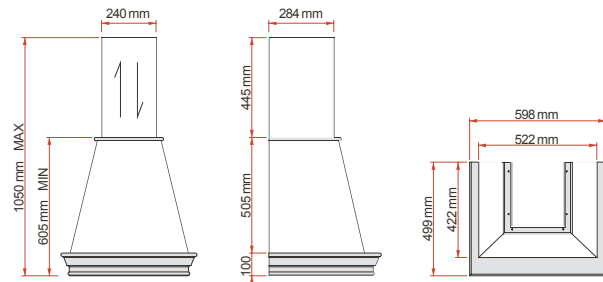

available colour range



* colouring of wooden hood elements may vary slightly from colouring of kitchen doors

hood technical data
on opposite side

classic corner hood



Amata 105**

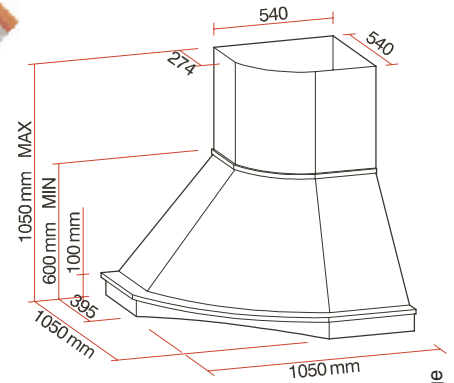

hood colouring shown in picture

remaining available colour range



Cream / Honey Alder*
[15] ARTYCJA XV DOBRA



Cream / Light Chestnut*
[11] STRATEGIO XI MADRY

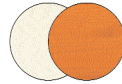

Cream / Chestnut*
[25] TRONIUSZ XXV SPRAWIEDLIWY



Cream / Morello Cherry*
[14] INSYGNATA XIV DUMNA



Cream / Dark Nut*
[16] DIADEMA XVI PIEKNA

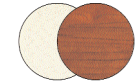

Cream / Walnut*
[22] IMPEROR XXII LASKAWY

* colouring of wooden hood elements may vary slightly from colouring of kitchen doors

hood technical data at the bottom of the page

technical characteristics of classic hoods width 60 cm and corner hood

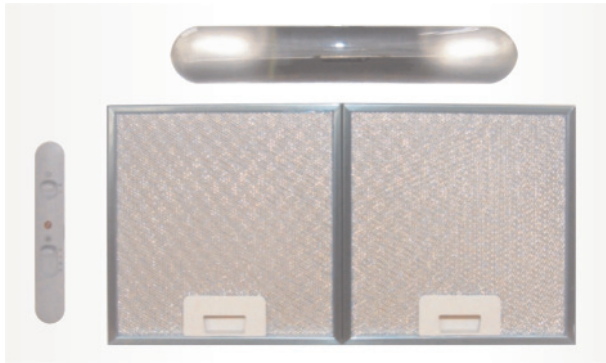

mechanism of classic hoods of width 60 cm

technical details	classic hoods width 60 cm	
	classic hood	classic corner hood
ranges of speed	1 2 3	
productivity (noisiness) at particular phases	150 m ³ /h (44 dbA) 300 m ³ /h (48 dbA) 450 m ³ /h (55 dbA)	
application	extraction / recirculation	
anti grease filter (metal)	x 2	
anti odour filter* (carbon)	type K186 x 2 (picture and description on p. 104)	
outlet diameter	120 mm	
lighting	2 x 25 W (max. 2 x 40W - option)	

* anti odour filters (carbon) are applied if hood has a re-circulation function

for kitchen	hood	colour	index
[11] STRATEGIO XI MADRY	Venus 60	Cream / Light Chestnut	AG-FAL-VENUS_60_KAJ
	Amata 105** (corner)	Cream / Light Chestnut	AG-FAL-AMATA_NAR_105_KAJ**
[22] IMPEROR XXII LASKAWY	Demeter 60	Cream / Walnut	AG-FAL-DEMETER_60_OW
	Amata 105** (corner)	Cream / Walnut	AG-FAL-AMATA_NAR_105_OW**
[25] TRONIUSZ XXV SPRAWIEDLIWY	Latona 60	Cream / Chestnut	AG-FAL-LATONA_60_KA
	Amata 105** (corner)	Cream / Chestnut	AG-FAL-AMATA_NAR_105_KA**
[14] INSYGNATA XIV DUMNA	Amata 60	Cream / Morello Cherry	AG-FAL-AMATA_60_WIS
	Amata 105** (corner)	Cream / Morello Cherry	AG-FAL-AMATA_NAR_105_WIS**
[15] ARTYCJA XV DOBRA	Amata 60	Cream / Honey Alder	AG-FAL-AMATA_60_OM
	Amata 105** (corner)	Cream / Honey Alder	AG-FAL-AMATA_NAR_105_OM**
[16] DIADEMA XVI PIEKNA	Amata 60	Cream / Dark Nut	AG-FAL-AMATA_60_OC
	Amata 105** (corner)	Cream / Dark Nut	AG-FAL-AMATA_NAR_105_OC**
<i>Melos</i> Orange Birch	Amata 60	Cream / Orange	AG-FAL-AMATA_60_ORN
	Amata 105** (corner)	Cream / Orange	AG-FAL-AMATA_NAR_105_ORN**

** Hood AMATE 105 will be available while stock lasts and will be then replaced by Hood AMATE 100.

modern hoods



Afrodite 60

colour INOX
AG-FAL-AFRODITE_60_IX



Afrodite 90

colour INOX
AG-FAL-AFRODITE_90_IX

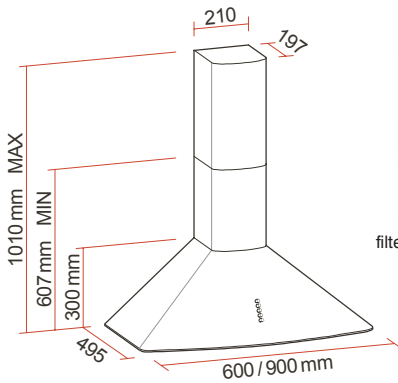

carbon filters type K186
filters may be ordered individually;
index: AG-FAL-K186-FILTR
filters are sold one by one

technical details	Afrodite 60	Afrodite 90
ranges of speed	1 2 3	
productivity (noisiness) at particular phases	285 m ³ /h (44 dbA) 345 m ³ /h (47 dbA) 450 m ³ /h (56 dbA)	
application	extraction / recirculation	
anti grease filter (metal)	x 2	x 3
anti odour filter* (carbon)	type K186 x 2	
outlet diameter	120 mm	
lighting	2 x 25 W (max. 2 x 40W - option)	

* anti odour filters (carbon) are applied if hood has a re-circulation function

Marte 60

colour INOX
AG-FAL-MARTE_60_IX



Marte 90

colour INOX
AG-FAL-MARTE_90_IX

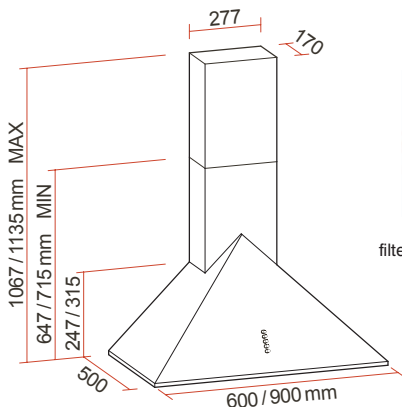

carbon filters type K186
filters may be ordered individually;
index: AG-FAL-K186-FILTR
filters are sold one by one

technical details	Marte 60	Marte 90
ranges of speed	1 2 3	
productivity (noisiness) at particular phases	285 m ³ /h (44 dbA) 345 m ³ /h (47 dbA) 450 m ³ /h (56 dbA)	
application	extraction / recirculation	
anti grease filter (metal)	x 2	x 3
anti odour filter* (carbon)	type K186 x 2	
outlet diameter	120 mm	
lighting	2 x 25 W (max. 2 x 40W - option)	

* anti odour filters (carbon) are applied if hood has a re-circulation function

modern hoods



Mercurio 60 X

colour INOX
AG-FAL-MERCURIO_60_IX

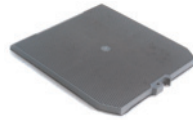
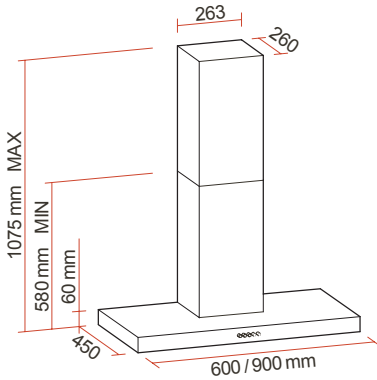

carbon filter type K220
filter may be ordered individually
index: AG-FAL-K220-FILTR
filter is sold by the item

Mercurio 90 X

colour INOX
AG-FAL-MERCURIO_90_IX



technical details	Mercurio 60 X	Mercurio 90 X
ranges of speed	1 2 3	
productivity (noisiness) at particular phases	285 m ³ /h (44 dbA) 345 m ³ /h (47 dbA) 450 m ³ /h (56 dbA)	
application	extraction / recirculation	
anti fat filter (metal)	x 2	x 3
anti smell filter* (carbon)	type K220 x 1	
outlet diameter	120 mm	
lighting	2 x 25 W (max. 2 x 40W - option)	

* anti smell filters (carbon) are applied if hood has a re-circulation function

Saturno Vetro 60 X

INOX / glazing
AG-FAL-SATURNO_60_IX/V

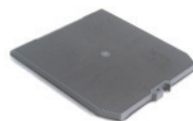
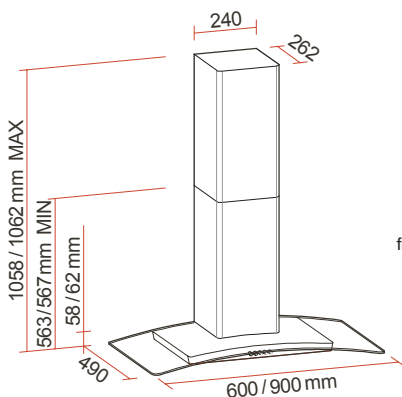

carbon filter type K220
filter may be ordered individually
index: AG-FAL-K220-FILTR
filter is sold by the item

Saturno Vetro 90 X

INOX / glazing
AG-FAL-SATURNO_90_IX/V



technical details	Saturno Vetro 60 X / 90 X
ranges of speed	1 2 3
productivity (noisiness) at particular phases	285 m ³ /h (44 dbA) 345 m ³ /h (47 dbA) 450 m ³ /h (56 dbA)
application	extraction / recirculation
anti fat filter (metal)	x 2
anti smell filter* (carbon)	type K220 x 1
outlet diameter	120 mm
lighting	2 x 25 W (max. 2 x 40W - option)

* anti smell filters (carbon) are applied if hood has a re-circulation function

tables for kitchen furniture offer

TRAX



STRATEGIO



STRATEGIO MINI



IMPEROR



IMPEROR MINI



TRONIUSZ



TRONIUSZ MINI



INSYGNATA



INSYGNATA MINI



DIADEMA



DIADEMA MINI



SAVOY Small



36th Avenue



34th Avenue



34th Avenue Mini



35th Avenue



35th Avenue Mini

for kitchen	table	colour	dimensions * (length/width/height)	index
[11] STRATEGIO XI MĄDRY	STRATEGIO	Light Chestnut	110-150/70/76	D09-TXS_STRATEGIO-TX026-1/1-KOR01
	STRATEGIO Mini	Light Chestnut	90/70/76	D09-TXS_STRATEGIO_MINI-TX026-1/1-KOR01
[22] IMPEROR XXII ŁASKAWY	IMPEROR	Walnut	120-150/70/77	D09-TXS_IMPEROR-TX012-KPL01
	IMPEROR Mini	Walnut	90/70/77	D09-TXS_IMPEROR_MINI-TX012-KPL01
[25] TRONIUSZ XXV SPRAWIEDLIWY	TRONIUSZ	Chestnut	110-150/70/76	D09-TXS_TRONIUSZ-TX027-1/1-KOR01
	TRONIUSZ Mini	Chestnut	90/70/76	D09-TXS_TRONIUSZ_MINI-TX027-1/1-KOR01
[14] INSYGNATA XIV DUMNA	INSYGNATA	Morello Cherry	125-165/75/77	D09-TXS_INSYGNATA-TX016-KPL01
	INSYGNATA Mini	Morello Cherry	90/70/77	D09-TXS_INSYGNATA_MINI-TX016-KPL01
[15] ARTYCJA XV DOBRA	SAVOY Small	Honey Alder	125/75/77	D09-TXS_SAVOY_SMALL-TX004-1/1-KOR01
[16] DIADEMA XVI PIĘKNA	DIADEMA	Dark Nut	120-150/70/77	D09-TXS_DIADEMA-TX011-1/1-KOR01
	DIADEMA Mini	Dark Nut	90/70/77	D09-TXS_DIADEMA_MINI-TX011-1/1-KOR01
34 th Avenue	34 th Avenue	Golden Alder	110-140/70/76	D09-TXS_AVENUE_34-TX005-KPL01
	34 th Avenue Mini	Golden Alder	90/70/75	D09-TXS_AVENUE_34_MINI-TX005-KPL01
35 th Avenue	35 th Avenue	Cherry	110-140/70/76	D09-TXS_AVENUE_35-TX009-KPL01
	35 th Avenue Mini	Cherry	90/70/75	D09-TXS_AVENUE_35_MINI-TX009-KPL01
36 th Avenue	36 th Avenue	Cherry	80/80/75	D09-TXS_AVENUE_36-TX009-KPL01

* dimensions are given in mm

chairs for kitchen furniture offer

TRAX



STRATEGIO

height 88 cm
width 44 cm
depth 52 cm



IMPEROR

height 89 cm
width 45 cm
depth 51 cm



TRONIUSZ

height 88 cm
width 44 cm
depth 52 cm



INSYGNATA

height 90 cm
width 47 cm
depth 53 cm



ARTYCJA

height 90 cm
width 43 cm
depth 45 cm



DIADEMA

height 89 cm
width 45 cm
depth 51 cm



34th Avenue

height 85 cm
width 44 cm
depth 43 cm



34th Avenue
soft

height 91 cm
width 44 cm
depth 45 cm



35th Avenue

height 85 cm
width 44 cm
depth 43 cm



35th Avenue
soft

height 91 cm
width 44 cm
depth 45 cm



36th Avenue

height 86 cm
width 42 cm
depth 49 cm

FABRICS



400



347 nubuk cream



golden pad

for kitchen	chair	colour	fabric	index
[11] STRATEGIO XI MĄDRY	STRATEGIO	Light Chestnut	347 nubuk cream	D09-TXK_STRATEGIO-TX026-1/1-TK347
[22] IMPEROR XXII ŁASKAWY	IMPEROR	Walnut	347 nubuk cream	D09-TXK_IMPEROR-TX012-1/1-TK347
[25] TRONIUSZ XXV SPRAWIEDLIWY	TRONIUSZ	Chestnut	347 nubuk cream	D09-TXK_TRONIUSZ-TX027-1/1-TK347
[14] INSYGNATA XIV DUMNA	INSYGNATA	Morello Cherry	347 nubuk cream	D09-TXK_INSYGNATA-TX016-1/1-TK347
[15] ARTYCJA XV DOBRA	ARTYCJA	Honey Alder	347 nubuk cream	D09-TXK_ARTYCJA-TX004-1/1-TK347
	ARTYCJA	Honey Alder	golden pad*	RS-TRAX/KRZESLO-OM-ARTYCJA-PAD_ZOLTY
[16] DIADEMA XVI PIĘKNA	DIADEMA	Dark Nut	347 nubuk cream	D09-TXK_DIADEMA-TX011-1/1-TK347
34th Avenue	34 th Avenue	Golden Alder	not present	D09-TXK_AVENUE_34_T-TX005-1/1-TK0
	34 th Avenue soft	Golden Alder	400	D09-TXK_AVENUE_34_M-TX005-1/1-TK400
35th Avenue	35 th Avenue	Cherry	not present	D09-TXK_AVENUE_35_T-TX009-1/1-TK0
	35 th Avenue soft	Cherry	400	D09-TXK_AVENUE_35_M-TX009-1/1-TK400
36th Avenue	36 th Avenue	Cherry	not present	D09-TXK_AVENUE_36-TX009-1/1-TK0

* till stocks are exhausted

tables and chairs are sold through **Logistic Centre** warehouse in Mielec

tables and chairs in non-standard colouring



colouring of tables

table	standard colour	non-standard colour
STRATEGIO	Light Chestnut	Walnut
STRATEGIO Mini	Light Chestnut	Walnut
IMPEROR	Walnut	Dark Nut
IMPEROR Mini	Walnut	Dark Nut
TRONIUSZ	Chestnut	Walnut
TRONIUSZ Mini	Chestnut	Walnut
INSYGNATA	Morello Cherry	all wood colours
INSYGNATA Mini	Morello Cherry	all wood colours
SAVOY Small	Honey Alder	all wood colours
DIADEMA	Dark Nut	Walnut
DIADEMA Mini	Dark Nut	Walnut
34 th Avenue	Golden Alder	not present
34 th Avenue Mini	Golden Alder	Antique Cherry
35 th Avenue	Cherry	Antique Cherry
35 th Avenue Mini	Cherry	Antique Cherry
36 th Avenue	Cherry	Antique Cherry

colouring and fabrics of chairs

chair	frame colour	fabric
STRATEGIO	all wood colours	all fabrics
IMPEROR	all wood colours	all fabrics
TRONIUSZ	all wood colours	all fabrics
INSYGNATA	all wood colours	all fabrics
ARTYCJA	all wood colours	all fabrics
DIADEMA	all wood colours	all fabrics
34 th Avenue	all wood colours	not present
34 th Avenue soft	all wood colours	all fabrics
35 th Avenue	all wood colours	not present
35 th Avenue soft	all wood colours	all fabrics
36 th Avenue	all wood colours	not present

example table index

D09-TXS_INSYGNATA_MINI-TX030-1/1-KOR01
 wood colouring

example chair index

D09-TXK_IMPEROR-TX030-1/1-TK406
 wood colouring fabric

Orders for non-standard tables and chairs should be made on a printed form or on the Internet at the **Sales Department in Bitgoraj** (clients supplied from wholesale stores place orders in **wholesale stores**).

In the case of non-standard tables and chairs expect longer delivery term and higher price.

fabrics



319



329



345



347



348

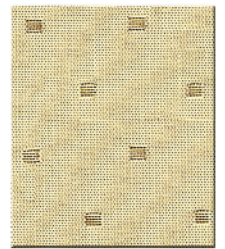

400

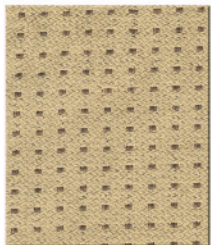

402



403



406



407

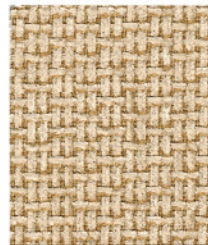

419



428



1000

Chosen fabric patterns are shown in the range.

As well as fabrics offered by the producer it is also possible to order chairs in fabric coverings.

For actual fabric patterns and details on ordering fabric covered chairs enquire at wholesale stores or at the **Sales Department in Bitgoraj**.

wood colouring

TRAX



Natural Adam

01

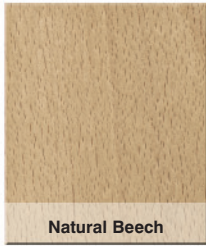

Natural Beech

02

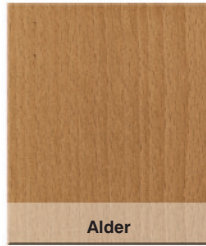

Alder

03

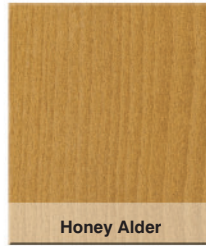

Honey Alder

04



Golden Alder 34th Avenue

05



Green Pine

06



Vis'a'vis Cherry

07

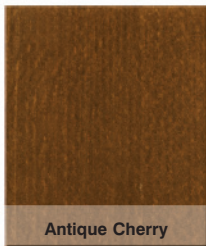

Antique Cherry

08

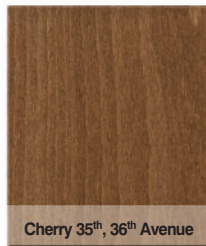

Cherry 35th, 36th Avenue

09

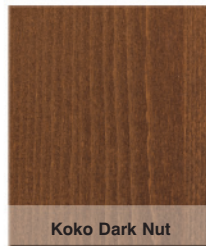

Koko Dark Nut

10

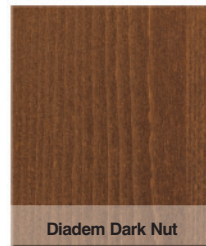

Diadem Dark Nut

11



Walnut

12



Light Nut

14

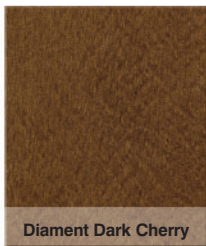

Diamant Dark Cherry

15

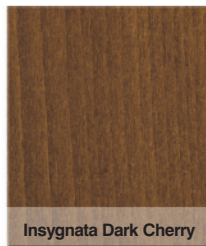

Insignata Dark Cherry

16

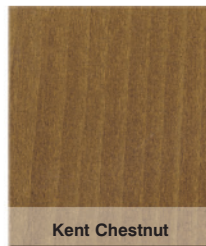

Kent Chestnut

17



Dark Apple

19



Kent Apple

20



Nida Maple

21

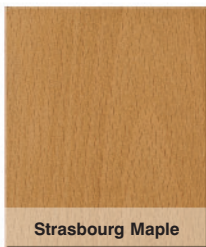

Strasbourg Maple

22



Wenge

23

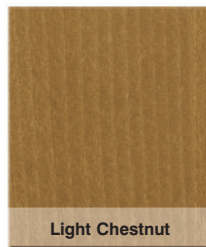

Light Chestnut

26

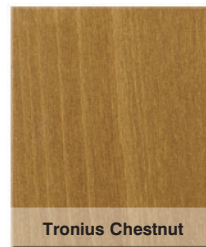

Tronius Chestnut

27



Golden Cherry

28



Milan Oak

29



Bavarian Cherry

30

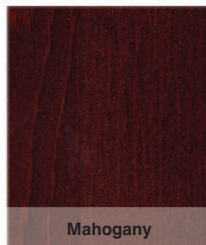

Mahogany

33

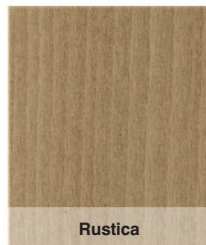

Rustica

35



Antique Pine

36



Sutter Oak

34



Gothic Oak

35



Niger Alder

36

full offer of tables and chairs is shown in the Trax-BRW catalogue



colour codes according to category

doors

acacia - 145
 alder - 114
 antique cherry - 151
 antique cherry patina - CRAP
 antique nut - ORAN
 antique oak - 143
 antique pine - 156
 apple - 125
 beech - [74], 108, BU
 beige - 148
 blue graphite - 119
 bordeaux gloss - 153
 calvados - 124
 calvados patina - CV_P
 celadon - 132
 celadon pine - 110
 cherry - [35], [36], [46]
 cherry cognac - 126
 chestnut - [25]
 cinamon oak - 111
 combed oak - 141
 copper red - 149
 cream - [61]
 dark apple - 138
 dark celadon - 131
 dark nut - [16]
 dark vanilla - [4], [71]
 dark vanilla - 127
 golden alder - [34]
 golden cherry - WIZ
 golden oak - 121
 green pea - [72]
 honey alder - [7], [15], [75], 133, OM
 honey alder patina - [3]P
 italian ash - 142
 italian cherry - 155
 italian cherry patina -WWP
 italian nut - [22]
 knotted pine - 109
 korean cherry - [56], [76], 135
 korean cherry patina - [12]P
 light beech - 107
 light chestnut - [11]
 light oak - 112
 light vanilla - [51]
 mahogany - 116
 malaga cherry - 139
 maple - 106
 maple cream - 105
 milan oak - DMI
 morello cherry - [14], 115
 nida maple - KLN
 nut patina - [9]
 orange - 150
 orange birch - BRORN
 pear - 137
 portofino cherry - 147
 rustic oak - 113
 samoan teak - 146
 siberian birch - 104
 smooth white - 102
 vanilla - [41]
 vanilla gloss - 154
 vertical oak - 144
 wenge - 140, WE
 white - 101
 white gloss - 152
 yellow - 117

glazing

clear - CZ
 clear with strip - CL
 diverso - DI
 rough - MR
 master - MA
 frosted - ML
 frosted with an ellipse - ME
 frosted with an rectangle pattern - MP

carcasses

beech - BU
 beige - BE
 chestnut - KA
 elba cherry - WISE
 electra cherry - WIEL
 grey - SZ
 medium chestnut - KAS
 milan oak - DMI
 nida maple - KLN
 portofino cherry - WISP
 san alder - OLS
 wenge - WE
 white - BI
 window - WIN
 windsor oak - DW

plinth strips

beech - BU
 beige - BE
 chestnut - KA
 elba cherry - WISE
 electra cherry - WIEL
 grey - SZ
 medium chestnut - KAS
 milan oak - DMI
 nida maple - KLN
 portofino cherry - WISP
 san alder - OLS
 silver - SRE
 wenge - WE
 white - BI
 windsor oak - DW

worktops

beige pietra - PB
 brick - CE
 cappuccino - CP
 golden granite - GRZ
 malaga green - MZ
 mint - MI
 old wood - SDR
 royal granite - GRR
 san alder - OLS
 sandstone - PI
 sanenberg beech - BUS
 silver - SRE
 travertine - TW
 white - BI
 white XXL - BIX

cornice and pelmet

acacia - 145
 alder - 114
 antique cherry - 151
 antique oak - 143
 antique pine - 156
 apple - 125
 beech - 108, BU
 beige - 148
 blue graphite - 119
 calvados - 124
 calvados patina - CV_P
 celadon - 132
 celadon pine - 110
 cherry cognac - 126
 chestnut - KA
 cinamon oak - 111
 combed oak - 141
 copper red - 149
 dark apple - 138
 dark celadon - 131
 dark nut - OC
 dark vanilla - 127
 elba cherry - WISE
 electra cherry - WIEL
 golden oak - 121
 honey alder - 133, OM
 honey alder patina - OMPA
 italian ash - 142
 italian cherry - 155
 italian cherry patina -WWP
 italian nut - OW
 knotted pine - 109
 korean cherry - 135
 korean cherry patina - WIKOP
 light beech - 107
 light chestnut - KAJ
 light oak - 112
 mahogany - 116
 malaga cherry - 139
 maple - 106
 maple cream - 105
 milan oak - DMI
 morello cherry - 115, WIS
 nida maple - KLN
 nut patina - ORPA
 orange - 150
 pear - 137
 portofino cherry - 147
 rustic oak - 113
 samoan teak - 146
 san alder - OLS
 siberian birch - 104
 smooth white - 102
 vertical oak - 144
 wenge - 140, WE
 white - 101
 windsor oak - DW
 yellow - 117

accessories

alder - OL
 aluminium - AL, ALU
 antique - ANT
 ash - PP
 beech - BU
 beige - BE
 beige pietra - PB
 blue - NI
 bottle green - ZB
 brass - MS
 brass patina - PT
 brick - CE
 bronze - BR
 brushed steel - STD
 cappuccino - CP
 chrome - CH, CR
 chrome-mat - CRM
 gold - ZL
 golden granite - GRZ
 granite - GR
 green - ZI
 grey - SZ
 light oak - DJ
 malaga green - MZ
 marble - MR
 mint - MI
 morello cherry - WIS
 nickel satin - NS
 nut - OR
 old wood - SDR
 royal granite - GRR
 san alder - OLS
 sandstone - PI
 sanenberg beech - BS
 satin - SA
 silver - SRE
 silver lacquer - S
 travertine - TW
 white - B, BI
 white XXL - BIX

hoods

chestnut - KA
 dark nut - OC
 honey alder - OM
 inox - IX
 italian nut - OW
 light chestnut - KAJ
 morello cherry - WIS
 orange - ORN

tables and chairs

(standard colourings of wooden elements)

cherry - 09
 chestnut - 27
 dark nut - 11
 golden alder - 05
 honey alder - 04
 italian nut - 12
 light chestnut - 26
 morello cherry - 16

colour codes A-Z

[3]P - honey alder patina / Trzy Życzenia Patyna (doors)
 [4] - dark vanilla / Cztery Pory Roku (doors)
 [7] - honey alder / Siódme Niebo (doors)
 [9] - nut patina / Dziewiąta Symfonia (doors)
 [11] - light chestnut / Strategio XI Mądry (doors)
 [12]P - korean cherry patina / Tuzin Róż Patyna (doors)
 [14] - morello cherry / Insignata XIV Dumna (doors)
 [15] - honey alder / Artycja XV Dobra (doors)
 [16] - dark nut / Diadema XVI Piękna (doors)
 [22] - italian nut / Imperor XXII Łaskawy (doors)
 [25] - chestnut / Troniusz XXV Sprawiedliwy (doors)
 [34] - golden alder / 34th Avenue (doors)
 [35] - cherry / 35th Avenue (doors)
 [36] - cherry / 36th Avenue (doors)
 [41] - vanilla / 41st Milk Street (doors)
 [46] - cherry / 46th Sesame Street (doors)
 51] - light vanilla / 51st Vanilla Street (doors)
 [56] - korean cherry / 56th Cherry Street (doors)
 [61] - cream / 61st Pudding Street (doors)
 [71] - dark vanilla / 71st Street (doors)
 [72] - green pea / 72nd Street (doors)
 [74] - beech / 74th Street (doors)
 [75] - honey alder / 75th Street (doors)
 [76] - korean cherry / 76th Street (doors)
 04 - honey alder (tables and chairs)
 05 - golden alder (tables and chairs)
 09 - cherry (tables and chairs)
 11 - dark nut (tables and chairs)
 12 - italian nut (tables and chairs)
 16 - morello cherry (tables and chairs)
 26 - light chestnut (tables and chairs)
 27 - chestnut (tables and chairs)
 101 - white (doors, cornice and pelmet)
 102 - smooth white (doors, cornice and pelmet)
 104 - siberian birch (doors, cornice and pelmet)
 105 - maple cream (doors, cornice and pelmet)
 106 - maple (doors, cornice and pelmet)
 107 - light beech (doors, cornice and pelmet)
 108 - beech (doors, cornice and pelmet)
 109 - knotted pine (doors, cornice and pelmet)
 110 - celadon pine (doors, cornice and pelmet)
 111 - cinamon oak (doors, cornice and pelmet)
 112 - light oak (doors, cornice and pelmet)
 113 - rustic oak (doors, cornice and pelmet)
 114 - alder (doors, cornice and pelmet)
 115 - morello cherry (doors, cornice and pelmet)
 116 - mahogany (doors, cornice and pelmet)
 117 - yellow (doors, cornice and pelmet)
 119 - blue graphite (doors, cornice and pelmet)
 121 - golden oak (doors, cornice and pelmet)
 124 - calvados (doors, cornice and pelmet)
 125 - apple (doors, cornice and pelmet)
 126 - cherry cognac (doors, cornice and pelmet)
 127 - dark vanilla (doors, cornice and pelmet)
 131 - dark celadon (doors, cornice and pelmet)
 132 - celadon (doors, cornice and pelmet)
 133 - honey alder (doors, cornice and pelmet)
 135 - korean cherry (doors, cornice and pelmet)
 137 - pear (doors, cornice and pelmet)
 138 - dark apple (doors, cornice and pelmet)
 139 - malaga cherry (doors, cornice and pelmet)
 140 - wenge (doors, cornice and pelmet)
 141 - combed oak (doors, cornice and pelmet)
 142 - italian ash (doors, cornice and pelmet)
 143 - antique oak (doors, cornice and pelmet)
 144 - vertical oak (doors, cornice and pelmet)
 145 - acacia (doors, cornice and pelmet)
 146 - samoan teak (doors, cornice and pelmet)
 147 - portofino cherry (doors, cornice and pelmet)
 148 - beige (doors, cornice and pelmet)
 149 - copper red (doors, crown strip and base strip)
 150 - orange (doors, cornice and pelmet)
 151 - antique cherry (doors, cornice and pelmet)
 152 - white gloss (doors)
 153 - bordeaux gloss (doors)
 154 - vanilla gloss (doors)
 155 - italian cherry (doors, cornice and pelmet)
 156 - antique pine (doors, cornice and pelmet)

A
 AL - aluminium (accessories)
 ALU - aluminium (accessories)
 ANT - antique (accessories)

B
 B - white (accessories)
 BE - beige (carcasses, plinth strips, accessories)
 BI - white (carcasses, plinth strips, worktops, accessories)
 BIX - white XXL (worktops, accessories)
 BR - bronze (accessories)
 BRORN - orange birch (doors)
 BS - sanenberg beech (accessories)
 BU - beech (doors, carcasses, plinth strips, cornice and pelmet, accessories)
 BUS - sanenberg beech (worktops)

C
 CE - brick (worktops, accessories)
 CH - chrome (accessories)
 CL - clear with strip (glazing)
 CP - cappuccino (worktops, accessories)
 CR - chrome (accessories)
 CRAP - antique cherry patina (doors)
 CRM - chrome-mat (accessories)
 CV_P - calvados patina (doors, cornice and pelmet)
 CZ - clear (glazing)

D
 DI - diverso (glazing)
 DJ - light oak (accessories)
 DMI - milan oak (doors, carcasses, plinth strips, cornice and pelmet)
 DW - windsor oak (carcasses, plinth strips, cornice and pelmet)

G
 GR - granite (worktops, accessories)
 GRR - royal granitree (worktops, accessories)
 GRZ - golden granitree (worktops, accessories)

I
 IX - inox (hoods)

K
 KA - chestnut (carcasses, plinth strips, cornice and pelmet, hoods)
 KAJ - light chestnut (cornice and pelmet, hoods)
 KAS - medium chestnut (carcasses)
 KLN - nida maple (doors, carcasses, plinth strips, cornice and pelmet)

M
 MA - master (glazing)
 ME - frosted with an ellipse (glazing)
 MI - mint (worktops, accessories)
 ML - frosted (glazing)
 MP - frosted with a rectangle pattern (glazing)
 MR - marble (accessories)
 MR - rough (glazing)
 MS - brass (accessories)
 MZ - malaga green (worktops, accessories)

N
 NI - blue (accessories)
 NS - nickel satin (accessories)

O
 OA - antique nut (doors)
 OC - dark nut (cornice and pelmet, accessories, hoods)
 OL - alder (accessories)
 OLS - san alder (carcasses, plinth strips, worktops, cornice and pelmet)
 OM - honey alder (doors, cornice and pelmet, hoods)
 OMPA - honey alder patina (cornice and pelmet)
 OR - nut (accessories)
 ORN - orange (hoods)
 ORPA - nut patina (cornice and pelmet)
 OW - italian nut (cornice and pelmet, hoods)

P
 PB - beige pietra (worktops, accessories)
 PI - sandstone (worktops, accessories)
 PP - ash (accessories)
 PT - brass patina (accessories)

S
 S - silver lacquer (accessories)
 SA - satin (accessories)
 SDR - old wood (worktops, accessories)
 SRE - silver (doors, plinth strips, worktops, accessories)
 STD - brushed steel (accessories)
 SZ - grey (carcasses, plinth strips, accessories)

T
 TW - travertine (worktops, accessories)

W
 WE - wenge (doors, carcasses, plinth strips, cornice and pelmet)
 WIEL - electra cherry (carcasses, plinth strips, cornice and pelmet)
 WIKOP - korean cherry patina (cornice and pelmet)
 WIN - window (carcasses)
 WIS - morello cherry (cornice and pelmet, accessories, hoods)
 WISE - elba cherry (carcasses, plinth strips, cornice and pelmet)
 WISP - portofino cherry (carcasses, plinth strips)
 WIZ - golden cherry (doors)
 WWP - italian cherry patina (doors, cornice and pelmet)

Z
 ZB - bottle green (accessories)
 ZI - green (accessories)
 ZL - golden (accessories)

index

D - lower

D-15/82p. 2
D-30/82-Lp. 2
D-30/82-Pp. 2
D-45/136-Lp. 3
D-45/136-LHp. 3
D-45/136-LVp. 3
D-45/136-LVAp. 3
D-45/136-LVA3p. 3
D-45/136-Pp. 4
D-45/136-PHp. 4
D-45/136-PVp. 4
D-45/136-PVAp. 4
D-45/136-PVA3p. 4
D-45/143-Lp. 4
D-45/143-LHp. 4
D-45/143-LVp. 4
D-45/143-PHp. 4
D-45/143-PVp. 4
D-45/207-L/Lp. 4
D-45/207-P/Pp. 4
D-45/82-Lp. 2
D-45/82-Pp. 2
D-60/82-Lp. 2
D-60/82-L/Pp. 2
D-60/82-Pp. 2
D-90/82-L/Pp. 3
D1SM/5-30/82-L/Sp. 7
D1SM/5-30/82-P/Sp. 7
D1SM/5-45/82-L/Sp. 7
D1SM/5-45/82-P/Sp. 7
D1SM/5-60/82-L/Sp. 7
D1SM/5-60/82-P/Sp. 7
D1SM/5-60/82-L/P/Sp. 7
D1ST/4-30/82-L/Sp. 10
D1ST/4-30/82-P/Sp. 10
D1ST/4-45/82-L/Sp. 10
D1ST/4-45/82-P/Sp. 10
D1ST/4-60/82-L/Sp. 10
D1ST/4-60/82-P/Sp. 10
D1ST/5-30/82-L/Sp. 14
D1ST/5-30/82-P/Sp. 14
D1ST/5-45/82-L/Sp. 14
D1ST/5-45/82-P/Sp. 14
D1ST/5-60/82-L/Sp. 15
D1ST/5-60/82-P/Sp. 15
D1ST/5-60/82-L/P/Sp. 15
DB/4-90/82-L/P/Bp. 3
DB/5-90/82-L/P/Bp. 3
DBK/4-90/82-L/P/Bp. 24
DBK/5-90/82-L/P/Bp. 25
DBNW45-4/82p. 32
DBNW60-5/82p. 32
DBSM/5-90/82-SV/Bp. 9
DBST/4-90/82-SH/Bp. 13
DBST/4-90/82-SV/Bp. 13
DBST/5-90/82-SV/Bp. 18
DBST/5-90/82-SH/Bp. 18
DBZ-5/82p. 32
DBZ-56/82p. 32
DC-30/207-C/Cp. 6
DC-30/82-Cp. 6
DCX-15/82-Cp. 6
DI-5/82-Bp. 32
DK-45/82-Lp. 24
DK-45/82-Pp. 24
DK-60/82-Lp. 24
DK-60/82-L/Pp. 24
DK-80/82-L/Pp. 24
DK-90/82-L/Pp. 24
DKSM/5-45/82-S/Bp. 25
DKSM/5-60/82-S/Bp. 25
DKSM/5-90/82-S/Bp. 25
DKST/4-45/82-S/Bp. 25
DKST/4-60/82-S/Bp. 25
DKST/5-45/82-S/Bp. 25
DKST/5-60/82-S/Bp. 25
DKST/5-90/82-S/Bp. 26
DL-60/136-Lp. 27
DL-60/136-Pp. 27
DL-60/143-Lp. 27
DL-60/143-Pp. 27
DL-60/207-L/Lp. 28
DL-60/207-P/Pp. 28
DL/NT160-60/207-L/Lp. 28
DL/NT160-60/207-P/Pp. 28
DL/NT160-60/230-L/L/Op. 29
DL/NT160-60/230-P/P/Op. 29
DL/NT180-60/207-L/Lp. 29
DL/NT180-60/207-P/Pp. 29
DL/NT180-60/230-L/L/Op. 29
DL/NT180-60/230-P/P/Op. 29
DLO-60/230-L/L/Op. 28
DLO-60/230-P/P/Op. 28
DM-45/57p. 27
DM-45/71p. 27
DM-60/57p. 27
DM-60/71p. 27
DNW-105/82-Lp. 20
DNW-105/82-Pp. 20
DNW-90/82-L/Lp. 20
DNW-90/82-P/Pp. 20
DNWL-105/136-L/Bp. 21
DNWL-105/143-L/Bp. 21
DNWP-105/136-P/Bp. 21
DNWP-105/143-P/Bp. 21

G - upper

DNWU-90/82-Lp. 20
DNWU-90/82-Pp. 20
DNWUST/4-90/82-2Sp. 20
DNWUST/4-90/82-S/2Sp. 21
DNWUST/5-90/82-2S/Sp. 21
DNWUST/5-90/82-S/3Sp. 21
DNZ-30/82p. 21
DNZL30/82p. 22
DNZP-30/82p. 23
DNZR-30/82p. 22
DNZRF-30/82-L/Lp. 22
DNZRF-30/82-P/Pp. 22
DNZRL-30/82p. 23
DNZRP-30/82p. 23
DNZU2F-30/82-L/LUp. 22
DNZU2F-30/82-P/PUp. 22
DNZUF-30/82-L/Lp. 22
DNZUF-30/82-P/Pp. 22
DO-45/230-L/L/Op. 5
DO-45/230-P/P/Op. 6
DP-60/136-L/Bp. 30
DP-60/136-P/Bp. 30
DP-60/143-Lp. 30
DP-60/143-Pp. 30
DP-60/207-L/Lp. 31
DP-60/207-P/Pp. 31
DP-60/82-Kp. 30
DP45-60/136-L/Bp. 31
DPP45O-60/207-L/Op. 31
DPP45O-60/207-P/Op. 31
DPS-60/82-Sp. 30
DPSX-60/82-Sp. 30
DSM/5-15/82-2S/Sp. 7
DSM/5-30/82-2S/Sp. 8
DSM/5-30/82-S/Sp. 8
DSM/5-30/82-S/3Sp. 8
DSM/5-45/136-5Sp. 9
DSM/5-45/136-5SVp. 9
DSM/5-45/82-2S/Sp. 8
DSM/5-45/82-S/3Sp. 8
DSM/5-60/82-2S/Sp. 8
DSM/5-60/82-S/3Sp. 8
DSM/5-90/82-2S/Sp. 8
DSM/5-90/82-2SV/Sp. 9
DSM/5-90/82-S/3Sp. 9
DSM/5-90/82-SV/3Sp. 9
DST/4-30/82-Sp. 10
DST/4-30/82-2Sp. 10
DST/4-30/82-S/2Sp. 11
DST/4-30/82-4Sp. 11
DST/4-45/143-2S/2SHp. 14
DST/4-45/143-2S/2SVp. 14
DST/4-45/143-2SH/2SHp. 14
DST/4-45/143-2SV/2SVp. 14
DST/4-45/82-2Sp. 11
DST/4-45/82-2SHp. 11
DST/4-45/82-2SVp. 11
DST/4-45/82-S/2Sp. 11
DST/4-45/82-SH/2Sp. 11
DST/4-45/82-SV/2Sp. 11
DST/4-45/82-4Sp. 12
DST/4-60/82-2Sp. 12
DST/4-60/82-2SHp. 12
DST/4-60/82-2SVp. 12
DST/4-60/82-S/2Sp. 12
DST/4-60/82-SH/2Sp. 12
DST/4-60/82-SV/2Sp. 12
DST/4-60/82-4Sp. 12
DST/4-90/82-2Sp. 13
DST/4-90/82-2SHp. 13
DST/4-90/82-2SVp. 13
DST/4-90/82-S/2Sp. 13
DST/4-90/82-SH/2Sp. 13
DST/4-90/82-SV/2Sp. 13
DST/4-90/82-SH/2Sp. 13
DST/4-90/82-SV/2Sp. 13
DST/5-120/82-2S/Sp. 18
DST/5-120/82-2SV/Sp. 18
DST/5-120/82-S/3Sp. 18
DST/5-120/82-SV/3Sp. 18
DST/5-30/82-S/Sp. 15
DST/5-30/82-2S/Sp. 15
DST/5-30/82-S/3Sp. 15
DST/5-45/136-5Sp. 18
DST/5-45/136-5SHp. 19
DST/5-45/136-5SVp. 18
DST/5-45/82-2S/Sp. 15
DST/5-45/82-2SH/Sp. 16
DST/5-45/82-2SV/Sp. 15
DST/5-45/82-S/3Sp. 16
DST/5-45/82-SH/3Sp. 16
DST/5-45/82-SV/3Sp. 16
DST/5-60/82-2S/Sp. 16
DST/5-60/82-2SH/Sp. 16
DST/5-60/82-2SV/Sp. 16
DST/5-60/82-S/3Sp. 16
DST/5-60/82-SH/3Sp. 17
DST/5-60/82-SV/3Sp. 17
DST/5-90/82-2S/Sp. 17
DST/5-90/82-2SH/Sp. 17
DST/5-90/82-2SV/Sp. 17
DST/5-90/82-S/3Sp. 17
DST/5-90/82-SH/3Sp. 17
DST/5-90/82-SV/3Sp. 17
DSWT/5-45/207-L/Lp. 19
DSWT/5-45/207-P/Pp. 19
DSY-45/82p. 32
DSY-60/82p. 32

T - standing on countertop

G-15/72p. 33
G-15/95p. 33
G-30/54-Lp. 33
G-30/54-Pp. 33
G-30/57-Lp. 33
G-30/57-Pp. 33
G-30/72-Lp. 33
G-30/72-Pp. 33
G-30/95-Lp. 34
G-30/95-Pp. 34
G-45/54-Lp. 34
G-45/54-Pp. 34
G-45/57-Lp. 34
G-45/57-Pp. 34
G-45/72-Lp. 35
G-45/72-LHp. 35
G-45/72-LVp. 35
G-45/72-LVAp. 35
G-45/72-LVA3p. 35
G-45/72-Pp. 35
G-45/72-PHp. 35
G-45/72-PVp. 35
G-45/72-PVAp. 36
G-45/72-PVA3p. 36
G-45/95-Lp. 36
G-45/95-LHp. 36
G-45/95-LVAp. 36
G-45/95-LVA3p. 36
G-45/95-Pp. 36
G-45/95-PHp. 37
G-45/95-PVp. 37
G-45/95-PVAp. 37
G-45/95-PVA3p. 37
G-60/54-Lp. 37
G-60/54-L/Pp. 37
G-60/54-Pp. 37
G-60/57-Lp. 37
G-60/57-L/Pp. 38
G-60/57-Pp. 38
G-60/72-Lp. 38
G-60/72-LHp. 38
G-60/72-L/Pp. 39
G-60/72-LVp. 38
G-60/72-LVAp. 38
G-60/72-LVA3p. 38
G-60/72-Pp. 38
G-60/72-PHp. 39
G-60/72-PVp. 39
G-60/72-PVAp. 39
G-60/72-PVA3p. 39
G-60/95-Lp. 39
G-60/95-LHp. 39
G-60/95-L/Pp. 40
G-60/95-LVp. 39
G-60/95-LVAp. 40
G-60/95-LVA3p. 40
G-60/95-Pp. 40
G-60/95-PHp. 40
G-60/95-PVp. 40
G-60/95-PVAp. 40
G-60/95-PVA3p. 40
G-90/72-L/Pp. 41
G-90/95-L/Pp. 41
G2O-60/72-2Op. 44
G2O-60/72-2OVp. 44
G2O-60/72-2OVAp. 44
G2O-60/72-2OVA3p. 44
G2O-90/72-2Op. 45
G2O-90/72-2OVp. 45
G2O-90/72-2OVAp. 45
G2O-90/72-2OVA3p. 45
GB/4-90/72-LH/PH/Bp. 41
GB/4-90/72-LV/PV/Bp. 41
GB/5-90/72-LH/PH/Bp. 41
GB/5-90/72-LV/PV/Bp. 41
GB/5-90/72-LV/PV/Bp. 41
GBO/4-90/72-OV/Bp. 45
GBO/4-90/72-OH/Bp. 45
GBO/5-90/57-OV/Bp. 45
GBO/5-90/57-OV/Bp. 45
GC-45/72-Lp. 51
GC-45/72-Pp. 51
GC-45/95-Lp. 51
GC-45/95-Pp. 51
GC-60/72-Lp. 51
GC-60/72-L/Pp. 51
GC-60/72-Pp. 51
GC-60/95-Lp. 51
GC-60/95-L/Pp. 52
GC-60/95-Pp. 52
GC-80/72-L/Pp. 52
GC-80/95-L/Pp. 52
GC-90/72-L/Pp. 52
GC-90/95-L/Pp. 52
GI-5/72-Bp. 54
GI-5/95-Bp. 54
GL-30/72/95-Lp. 34
GNW-60/72-L/Lp. 46
GNW-60/72-P/Pp. 46
GNW-60/95-L/Lp. 46
GNW-60/95-P/Pp. 46
GNWU-60/72-Lp. 46
GNWU-60/72-LHp. 46
GNWU-60/72-LVp. 46
GNWU-60/72-Pp. 46
GNWU-60/72-PHp. 47

GNWU-60/72-PVp. 47
GNWU-60/95-Lp. 47
GNWU-60/95-LHp. 47
GNWU-60/95-LVp. 47
GNWU-60/95-Pp. 47
GNWU-60/95-PHp. 47
GNWU-60/95-PVp. 47
GNZ-30/72p. 48
GNZ-30/95p. 48
GNZR-30/72p. 49
GNZR-30/95p. 49
GNZRF-30/72-LRVp. 50
GNZRF-30/72-PRVp. 50
GNZRF-30/72-PRVp. 50
GNZRF-30/95-LRVp. 50
GNZRF-30/95-PRVp. 50
GNZU2F-30/72-LUHp. 48
GNZU2F-30/72-LUVp. 48
GNZU2F-30/72-PUHp. 49
GNZU2F-30/72-PUVp. 49
GNZU2F-30/95-LUHp. 49
GNZU2F-30/95-LUVp. 49
GNZU2F-30/95-PUHp. 49
GNZU2F-30/95-PUVp. 49
GO-120/36-Op. 43
GO-120/36-OVp. 44
GO-120/36-OVAp. 44
GO-120/36-OVA3p. 44
GO-45/36-Op. 42
GO-45/36-OHp. 42
GO-45/36-OVp. 42
GO-45/36-OVAp. 42
GO-45/36-OVA3p. 42
GO-50/36-Op. 42
GO-60/36-Op. 42
GO-60/36-OHp. 43
GO-60/36-OVp. 42
GO-60/36-OVAp. 43
GO-60/36-OVA3p. 43
GO-90/36-Op. 43
GO-90/36-OVp. 43
GO-90/36-OVAp. 43
GO-90/36-OVA3p. 43
GO2/5-90/72-OV/L/Pp. 45
GOO-60/50-Op. 53
GP-30/72/95-Pp. 34
GP35-60/43p. 53
GS-30/14-2Sp. 54
GS-30/15-2Sp. 54
GS-45/14-3Sp. 54
GS-45/15-3Sp. 54
KORONA-150/14p. 54

ATTENTION: feet are included in cabinet height; to calculate carcass height without feet subtract 100 mm from given measurements

BI WIEL
 BE WISE
 DMI WISP
 DW SZ
 KLN
 WE
 OLS

Royal [14] [15] [16]
 CAPITAL [34] [35] [36]
 Classic
 Modern
 BRUNNEN
 Dekorado Ledo Melos Rosa
 Diona Hedar Telesio
 FAL KAR POR EKR TAF_MDF

D1ST/5-45/82-L/S

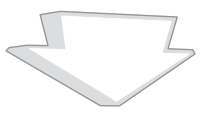
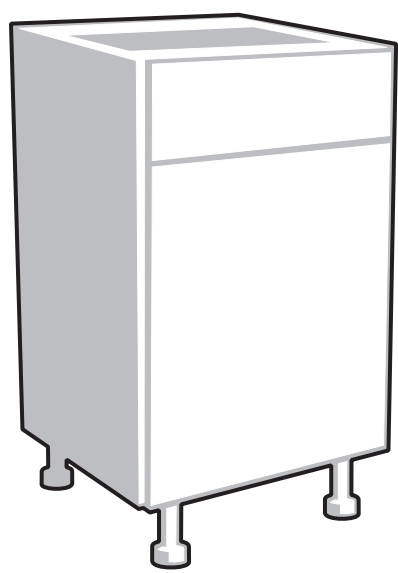

DS-45-N-KOR

140/446-ST

570/446-L

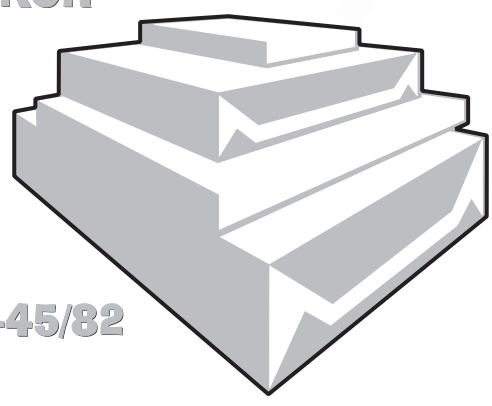









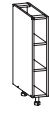



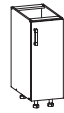



D1ST/5-45/82







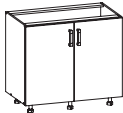
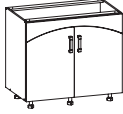
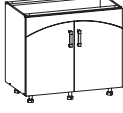

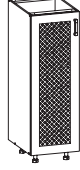
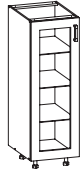
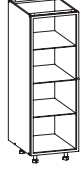
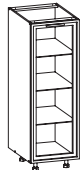

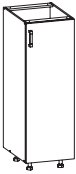

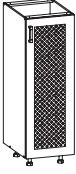

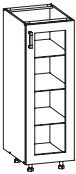
- base units & cargo p. 2
- base units with drawers p. 7
- corner base units p. 20
- sink units p. 24
- lower cabinets for housing domestic equipment p. 27
- additional base units p. 32
- wall units p. 33
- hood units* p. 42
- corner wall units p. 46
- drainer units p. 51
- integrated hood units p. 53
- additional wall units p. 54
- dresser units p. 55

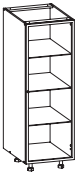

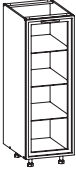

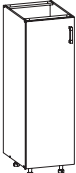

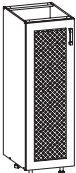

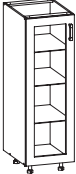



CABINETS IN SPK

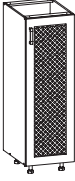

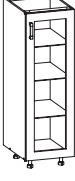
* with doors opening upwards

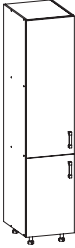

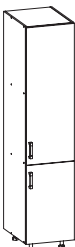

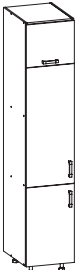

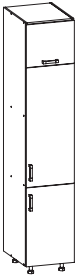
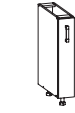











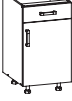

D-15/82		packages	carcass dimensions	carcass colours	available in	comments
		carcass D-15/82	width 150 mm	BI KLN	<i>Royal</i>	[11] [22] [25] [14] [15] [16]
			depth 508 mm	BE OLS	CAPITAL	[34] [35] [36]
			height 820 mm	BU WE	<i>Sentima</i>	[3]P [4] [7] [9] [12]P
				DMI WIEL	TRAFFIC	[4-] [5-] [6-] [7-]
				DW WISE	<i>Classic</i>	<i>Dekorado Ledo Melos Rosa</i>
				KA WISP	Modern	Diona Hedar Telesto
				KAS SZ	BRW	FAL KAR POR EKR TAF_MDF
D-30/82-L		packages	carcass dimensions	carcass colours	available in	comments
		carcass D-30/82	width 300 mm	BI KLN	<i>Royal</i>	[11] [22] [25] [14] [15] [16]
		door 713/296 (-L)	depth 508 mm	BE OLS	CAPITAL	[34] [35] [36]
			height 820 mm	BU WE	<i>Sentima</i>	[3]P [4] [7] [9] [12]P
				DMI WIEL	TRAFFIC	[4-] [5-] [6-] [7-]
				DW WISE	<i>Classic</i>	<i>Dekorado Ledo Melos Rosa</i>
				KA WISP	Modern	Diona Hedar Telesto
				KAS SZ	BRW	FAL KAR POR EKR TAF_MDF
D-30/82-P		packages	carcass dimensions	carcass colours	available in	comments
		carcass D-30/82	width 300 mm	BI KLN	<i>Royal</i>	[11] [22] [25] [14] [15] [16]
		door 713/296 (-P)	depth 508 mm	BE OLS	CAPITAL	[34] [35] [36]
			height 820 mm	BU WE	<i>Sentima</i>	[3]P [4] [7] [9] [12]P
				DMI WIEL	TRAFFIC	[4-] [5-] [6-] [7-]
				DW WISE	<i>Classic</i>	<i>Dekorado Ledo Melos Rosa</i>
				KA WISP	Modern	Diona Hedar Telesto
				KAS SZ	BRW	FAL KAR POR EKR TAF_MDF
D-45/82-L		packages	carcass dimensions	carcass colours	available in	comments
		carcass D-45/82	width 450 mm	BI KLN	<i>Royal</i>	[11] [22] [25] [14] [15] [16]
		door 713/446 (-L)	depth 508 mm	BE OLS	CAPITAL	[34] [35] [36]
			height 820 mm	BU WE	<i>Sentima</i>	[3]P [4] [7] [9] [12]P
				DMI WIEL	TRAFFIC	[4-] [5-] [6-] [7-]
				DW WISE	<i>Classic</i>	<i>Dekorado Ledo Melos Rosa</i>
				KA WISP	Modern	Diona Hedar Telesto
				KAS SZ	BRW	FAL KAR POR EKR TAF_MDF
D-45/82-P		packages	carcass dimensions	carcass colours	available in	comments
		carcass D-45/82	width 450 mm	BI KLN	<i>Royal</i>	[11] [22] [25] [14] [15] [16]
		door 713/446 (-P)	depth 508 mm	BE OLS	CAPITAL	[34] [35] [36]
			height 820 mm	BU WE	<i>Sentima</i>	[3]P [4] [7] [9] [12]P
				DMI WIEL	TRAFFIC	[4-] [5-] [6-] [7-]
				DW WISE	<i>Classic</i>	<i>Dekorado Ledo Melos Rosa</i>
				KA WISP	Modern	Diona Hedar Telesto
				KAS SZ	BRW	FAL KAR POR EKR TAF_MDF
D-60/82-L		packages	carcass dimensions	carcass colours	available in	comments
		carcass D-60/82	width 600 mm	BI KLN	<i>Royal</i>	[11] [22] [25] [14] [15] [16]
		door 713/596 (-L)	depth 508 mm	BE OLS	CAPITAL	[34] [35] [36]
			height 820 mm	BU WE	<i>Sentima</i>	[3]P [4] [7] [9] [12]P
				DMI WIEL	TRAFFIC	[4-] [5-] [6-] [7-]
				DW WISE	<i>Classic</i>	<i>Dekorado Ledo Melos Rosa</i>
				KA WISP	Modern	Diona Hedar Telesto
				KAS SZ	BRW	FAL KAR POR EKR TAF_MDF
D-60/82-P		packages	carcass dimensions	carcass colours	available in	comments
		carcass D-60/82	width 600 mm	BI KLN	<i>Royal</i>	[11] [22] [25] [14] [15] [16]
		door 713/596 (-P)	depth 508 mm	BE OLS	CAPITAL	[34] [35] [36]
			height 820 mm	BU WE	<i>Sentima</i>	[3]P [4] [7] [9] [12]P
				DMI WIEL	TRAFFIC	[4-] [5-] [6-] [7-]
				DW WISE	<i>Classic</i>	<i>Dekorado Ledo Melos Rosa</i>
				KA WISP	Modern	Diona Hedar Telesto
				KAS SZ	BRW	FAL KAR POR EKR TAF_MDF
D-60/82-L/P		packages	carcass dimensions	carcass colours	available in	comments
		carcass D-60/82	width 600 mm	BI KLN	<i>Royal</i>	[11] [22] [25] [14] [15] [16]
		doors 713/296 (-L) 713/296 (-P)	depth 508 mm	BE OLS	CAPITAL	[34] [35] [36]
			height 820 mm	BU WE	<i>Sentima</i>	[3]P [4] [7] [9] [12]P
				DMI WIEL	TRAFFIC	[4-] [5-] [6-] [7-]
				DW WISE	<i>Classic</i>	<i>Dekorado Ledo Melos Rosa</i>
				KA WISP	Modern	Diona Hedar Telesto
				KAS SZ	BRW	FAL KAR POR EKR TAF_MDF

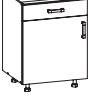

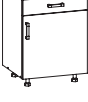

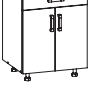

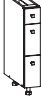







		packages	carcass dimensions	carcass colours		available in	comments
	carcass	D-90/82	width 900 mm	BI KLN	<i>Royal</i> CAPITAL <i>Sentima</i> TRAFFIC <i>Classic</i> Modern BRW	[11] [22] [25] [14] [15] [16]	
	doors	713/446 (-L) 713/446 (-P)	depth 508 mm height 820 mm	BE OLS BU WE DMI WIEL DW WISE KA WISP KAS SZ		[34] [35] [36] [3]P [4] [7] [9] [12]P [4-] [5-] [6-] [7-] <i>Dekorado Ledo Melos Rosa</i> Diona Hedar Telesto <i>FAL KAR POR EKR TAF_MDF</i>	
	carcass	DB/4-90/82	width 900 mm	KA	<i>Royal</i>	[22]	
	doors	633/446-LE 633/446-PE 176/896-E	depth 508 mm height 820 mm				
	carcass	DB/5-90/82	width 900 mm	BI WE	<i>Royal</i> <i>Sentima</i> <i>Classic</i> BRW	[14] [15]	* depending on kitchen doors may have different measurements: 615/446-LE (-PE) - [7] 615/446-LDE (-PDE) - FAL 620/446-LE (-PE) - [4] [12]P 620/446-LDE (-PDE) - <i>Ledo Rosa</i> <i>Melos KAR POR</i> 621/446-LDE (-PDE) - [14] 645/446-LDE (-PDE) - [15]
	doors	620/446-LE* (-LDE*) 620/446-PE* (-PDE*) 140/896-E	depth 508 mm height 820 mm	BE WIEL BU WISE DMI WISP DW SZ KLN OLS		[4] [7] [12]P <i>Ledo Melos Rosa</i> <i>FAL KAR POR</i>	
	carcass	D-45/136	width 450 mm	BU	<i>Royal</i> CAPITAL <i>Sentima</i> TRAFFIC	[14] [15] [16]	
	door	1261/446 (-L)	depth 560 mm height 1364 mm	DW OLS WIEL WISE WISP		[34] [35] [36] [3]P [4] [7] [9] [12]P [4-] [5-] [6-] [7-]	
	carcass	D-45/136	width 450 mm	BU	<i>Royal</i>	[15] [16]	
	door	1261/446-LH	depth 560 mm height 1364 mm	DW OLS WIEL WISE WISP			
	carcass	D-45/136	width 450 mm	BU	<i>Royal</i> CAPITAL <i>Sentima</i> TRAFFIC	[14] [15] [16]	* concerns doors, in which glazing is not factory mounted
	door	1261/446-V (-LV)	depth 560 mm	DW OLS WIEL WISE WISP		[34] [35] [3]P [4] [7] [9] [12]P [5-] [6-] [7-]	
glazing	1261/446-V*	height 1364 mm					
	carcass	D-45/136	width 450 mm	BU	CAPITAL TRAFFIC	[34] [35] [36]	
	door	1261/446-VA	depth 560 mm height 1364 mm	DW OLS WIEL WISE WISP		[4-] [5-] [7-]	
	carcass	D-45/136	width 450 mm	BU	CAPITAL TRAFFIC	[34] [35] [36]	
	door	1261/446-LVA3	depth 560 mm height 1364 mm	DW OLS WIEL WISE WISP		[4-] [5-] [7-]	

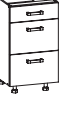







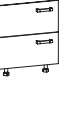

D-45/136-P		packages	carcass dimensions		carcass colours	available in	comments
5 		<u>carcass</u> D-45/136	<u>width</u> 450 mm	BU DW OLS WIEL WISE WISP	<i>Royal</i> CAPITAL <i>Sentima</i> TRAFFIC	[14] [15] [16] [34] [35] [36]	
		<u>door</u> 1261/446 (-P)	<u>depth</u> 560 mm				
		<u>height</u> 1364 mm				[3]P [4] [7] [9] [12]P [4-] [5-] [6-] [7-]	
D-45/136-PH		packages	carcass dimensions		carcass colours	available in	comments
5 		<u>carcass</u> D-45/136	<u>width</u> 450 mm	BU DW OLS WIEL WISE WISP	<i>Royal</i>	[15] [16]	
		<u>door</u> 1261/446-PH	<u>depth</u> 560 mm				
		<u>height</u> 1364 mm					
D-45/136-PV		packages	carcass dimensions		carcass colours	available in	comments
5 		<u>carcass</u> D-45/136	<u>width</u> 450 mm	BU DW OLS WIEL WISE WISP	<i>Royal</i> CAPITAL <i>Sentima</i> TRAFFIC	[14] [15] [16] [34] [35]	* concerns doors, in which glazing is not factory mounted
		<u>door</u> 1261/446-V (-PV)	<u>depth</u> 560 mm				
		<u>glazing</u> 1261/446-V*	<u>height</u> 1364 mm			[3]P [4] [7] [9] [12]P [5-] [6-] [7-]	
D-45/136-PVA		packages	carcass dimensions		carcass colours	available in	comments
5 		<u>carcass</u> D-45/136	<u>width</u> 450 mm	BU DW OLS WIEL WISE WISP	CAPITAL TRAFFIC	[34] [35] [36] [4-] [5-] [7-]	
		<u>door</u> 1261/446-VA	<u>depth</u> 560 mm				
		<u>height</u> 1364 mm					
D-45/136-PVA3		packages	carcass dimensions		carcass colours	available in	comments
5 		<u>carcass</u> D-45/136	<u>width</u> 450 mm	BU DW OLS WIEL WISE WISP	CAPITAL TRAFFIC	[34] [35] [36] [4-] [5-] [7-]	
		<u>door</u> 1261/446-PVA3	<u>depth</u> 560 mm				
		<u>height</u> 1364 mm					
D-45/143-L		packages	carcass dimensions		carcass colours	available in	comments
4 		<u>carcass</u> D-45/143	<u>width</u> 450 mm	KA KAS	<i>Royal</i>	[11] [22] [25]	
		<u>door</u> 1327/446 (-L)	<u>depth</u> 560 mm				
		<u>height</u> 1430 mm					
D-45/143-LH		packages	carcass dimensions		carcass colours	available in	comments
4 		<u>carcass</u> D-45/143	<u>width</u> 450 mm	KA KAS	<i>Royal</i>	[11] [22] [25]	
		<u>door</u> 1327/446-H (-LH)	<u>depth</u> 560 mm				
		<u>height</u> 1430 mm					
D-45/143-LV		packages	carcass dimensions		carcass colours	available in	comments
4 		<u>carcass</u> D-45/143	<u>width</u> 450 mm	KA KAS	<i>Royal</i>	[11] [22] [25]	
		<u>door</u> 1327/446-V (-LV)	<u>depth</u> 560 mm				
		<u>height</u> 1430 mm					





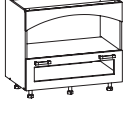



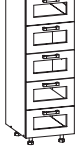







D-45/143-P		packages	carcass dimensions		carcass colours	available in	comments
 4 		carcass	D-45/143	width	450 mm	KA	<i>Royal</i> [11] [22] [25]
		door	1327/446 (-P)	depth	560 mm	KAS	
				height	1430 mm		
D-45/143-PH		packages	carcass dimensions		carcass colours	available in	comments
 4 		carcass	D-45/143	width	450 mm	KA	<i>Royal</i> [11] [22] [25]
		door	1327/446-H (-PH)	depth	560 mm	KAS	
				height	1430 mm		
D-45/143-PV		packages	carcass dimensions		carcass colours	available in	comments
 5 		carcass	D-45/143	width	450 mm	KA	<i>Royal</i> [11] [22] [25]
		door	1327/446-V (-PV)	depth	560 mm	KAS	
				height	1430 mm		
D-45/207-L/L		packages	carcass dimensions		carcass colours	available in	comments
		carcass	D-45/207	width	450 mm	BI KLN	<i>Royal</i> [11] [22] [25] [14] [15] [16] CAPITAL [34] [35] [36] <i>Sentima</i> [3]P [4] [7] [9] [12]P TRAFFIC [4-] [5-] [6-] [7-] <i>Classic</i> <i>Dekorado Ledo Melos Rosa</i> Modern Diona Hedar Telesto BRW <i>FAL KAR POR EKR TAF_MDF</i>
		doors	713/446 (-L) 1247/446 (-L)	depth	560 mm	BE OLS BU WE DMI WIEL DW WISE KA WISP KAS SZ	
				height	2066 mm		
D-45/207-P/P		packages	carcass dimensions		carcass colours	available in	comments
		carcass	D-45/207	width	450 mm	BI KLN	<i>Royal</i> [11] [22] [25] [14] [15] [16] CAPITAL [34] [35] [36] <i>Sentima</i> [3]P [4] [7] [9] [12]P TRAFFIC [4-] [5-] [6-] [7-] <i>Classic</i> <i>Dekorado Ledo Melos Rosa</i> Modern Diona Hedar Telesto BRW <i>FAL KAR POR EKR TAF_MDF</i>
		doors	713/446 (-P) 1247/446 (-P)	depth	560 mm	BE OLS BU WE DMI WIEL DW WISE KA WISP KAS SZ	
				height	2066 mm		
DO-45/230-L/L/O		packages	carcass dimensions		carcass colours	available in	comments
		carcass	DO-45/230	width	450 mm	BU	<i>Royal</i> [11] [22] [25] [14] [15] [16] CAPITAL [34] [35] [36] <i>Sentima</i> [3]P [4] [7] [9] [12]P TRAFFIC [4-] [5-] [6-] [7-]
		doors	713/446 (-L) 1081/446 (-L) 393/446-O	depth	560 mm	DW KA KAS OLS WIEL WISE WISP	
				height	2296 mm		

















DO-45/230-P/P/O		packages	carcass dimensions		carcass colours	available in	comments
	carcass	DO-45/230	width	450 mm	BU	<i>Royal</i>	[11] [22] [25] [14] [15] [16]
	doors	713/446 (-P) 1081/446 (-P) 393/446-O	depth	560 mm	DW	CAPITAL	[34] [35] [36]
	carcass	DCX-15/82	width	150 mm	BI KLN	<i>Royal</i>	[11] [22] [25] [14] [15] [16]
	door	713/146-CX	depth	508 mm	BE OLS	CAPITAL	[34] [35] [36]
	carcass	DC-30/82	width	300 mm	BU WISP	<i>Royal</i>	[11] [22] [25] [14] [15] [16]
	door	713/396-C	depth	508 mm	DW	CAPITAL	[34] [35] [36]
	carcass	DC-30/207	width	300 mm	BU	<i>Royal</i>	[11] [22] [25] [14] [15] [16]
	door	713/296-CC 1247/296-CC	depth	560 mm	DW	CAPITAL	[34] [35] [36]
			height	2296 mm	KA	<i>Sentima</i>	[3]P [4] [7] [9] [12]P
					KAS	TRAFFIC	[4-] [5-] [6-] [7-]
					OLS		
					WIEL		
					WISE		
					WISP		
						<i>Classic</i>	<i>Dekorado Ledo Melos Rosa</i>
						<i>Modern</i>	Diona Hedar Telesto
						BRW	FAL KAR POR EKR TAF_MDF
							comments
							cargo basket is mounted on cabinet side prior to assembly
							cargo basket must be separately ordered
							comments
							cargo basket is secured to bottom of cabinet
							cargo basket must be separately ordered
							comments
							cargo basket is secured to bottom of cabinet
							cargo basket must be separately ordered













D1SM/5-30/82-L/S		packages	carcass dimensions		carcass colours		available in	comments	
		carcass	D1SM/5-30/82	width	300 mm	BI	OLS	<i>Sentima</i> [3]P [4] [7] [9] [12]P <i>TRAFFIC</i> [4-] [5-] [6-] [7-] <i>Classic</i> Dekorado Ledo Melos Rosa <i>Modern</i> Diona Hedar Telesto  FAL KAR POR EKR TAF_MDF	drawer on METABOX® blum rails
		doors	570/296 (-L) 140/296-SM	depth	508 mm	BE	WIEL		
		drawer	SM-320M4500 SM-140/296/450	height	820 mm	BU	WISE		
						DMI	SZ		
				DW					
				KLN					
				WE					
D1SM/5-30/82-P/S		packages	carcass dimensions		carcass colours		available in	comments	
		carcass	D1SM/5-30/82	width	300 mm	BI	OLS	<i>Sentima</i> [3]P [4] [7] [9] [12]P <i>TRAFFIC</i> [4-] [5-] [6-] [7-] <i>Classic</i> Dekorado Ledo Melos Rosa <i>Modern</i> Diona Hedar Telesto  FAL KAR POR EKR TAF_MDF	drawer on METABOX® blum rails
		doors	570/296 (-P) 140/296-SM	depth	508 mm	BE	WIEL		
		drawer	SM-320M4500 SM-140/296/450	height	820 mm	BU	WISE		
						DMI	SZ		
				DW					
				KLN					
				WE					
D1SM/5-45/82-L/S		packages	carcass dimensions		carcass colours		available in	comments	
		carcass	D1SM/5-45/82	width	450 mm	BI	OLS	<i>Sentima</i> [3]P [4] [7] [9] [12]P <i>TRAFFIC</i> [4-] [5-] [6-] [7-] <i>Classic</i> Dekorado Ledo Melos Rosa <i>Modern</i> Diona Hedar Telesto  FAL KAR POR EKR TAF_MDF	drawer on METABOX® blum rails
		doors	570/446 (-L) 140/446-SM	depth	508 mm	BE	WIEL		
		drawer	SM-320M4500 SM-140/446/450	height	820 mm	BU	WISE		
						DMI	SZ		
				DW					
				KLN					
				WE					
D1SM/5-45/82-P/S		packages	carcass dimensions		carcass colours		available in	comments	
		carcass	D1SM/5-45/82	width	450 mm	BI	OLS	<i>Sentima</i> [3]P [4] [7] [9] [12]P <i>TRAFFIC</i> [4-] [5-] [6-] [7-] <i>Classic</i> Dekorado Ledo Melos Rosa <i>Modern</i> Diona Hedar Telesto  FAL KAR POR EKR TAF_MDF	drawer on METABOX® blum rails
		doors	570/446 (-P) 140/446-SM	depth	508 mm	BE	WIEL		
		drawer	SM-320M4500 SM-140/446/450	height	820 mm	BU	WISE		
						DMI	SZ		
				DW					
				KLN					
				WE					
D1SM/5-60/82-L/S		packages	carcass dimensions		carcass colours		available in	comments	
		carcass	D1SM/5-60/82	width	600 mm	BI	OLS	<i>Sentima</i> [3]P [4] [7] [9] [12]P <i>TRAFFIC</i> [4-] [5-] [6-] [7-] <i>Classic</i> Dekorado Ledo Melos Rosa <i>Modern</i> Diona Hedar Telesto  FAL KAR POR EKR TAF_MDF	drawer on METABOX® blum rails
		doors	570/596 (-L) 140/596-SM	depth	508 mm	BE	WIEL		
		drawer	SM-320M4500 SM-140/596/450	height	820 mm	BU	WISE		
						DMI	SZ		
				DW					
				KLN					
				WE					
D1SM/5-60/82-P/S		packages	carcass dimensions		carcass colours		available in	comments	
		carcass	D1SM/5-60/82	width	600 mm	BI	OLS	<i>Sentima</i> [3]P [4] [7] [9] [12]P <i>TRAFFIC</i> [4-] [5-] [6-] [7-] <i>Classic</i> Dekorado Ledo Melos Rosa <i>Modern</i> Diona Hedar Telesto  FAL KAR POR EKR TAF_MDF	drawer on METABOX® blum rails
		doors	570/596 (-P) 140/596-SM	depth	508 mm	BE	WIEL		
		drawer	SM-320M4500 SM-140/596/450	height	820 mm	BU	WISE		
						DMI	SZ		
				DW					
				KLN					
				WE					
D1SM/5-60/82-L/P/S		packages	carcass dimensions		carcass colours		available in	comments	
		carcass	D1SM/5-60/82	width	600 mm	BI	OLS	<i>Sentima</i> [3]P [4] [7] [9] [12]P <i>TRAFFIC</i> [4-] [5-] [6-] [7-]	drawer on METABOX® blum rails
		doors	570/296 (-L) 570/296 (-P) 140/596-SM	depth	508 mm	BE	WIEL		
		drawer	SM-320M4500 SM-140/596/450	height	820 mm	BU	WISE		
						DMI	SZ		
				DW					
				KLN					
				WE					
DSM/5-15/82-2S/S		packages	carcass dimensions		carcass colours		available in	comments	
		carcass	DSM/5-15/82	width	150 mm	BI	OLS	<i>Classic</i> Dekorado Ledo Melos Rosa <i>Modern</i> Diona Hedar Telesto  FAL KAR POR EKR TAF_MDF	drawer on METABOX® blum rails
		doors	284/146-SMx2 140/146-SM	depth	508 mm	BE	WIEL		
		drawers	SMR-320M4500x2 SM-320M4500 SMR-284/146/450 SM-140/146/450	height	820 mm	BU	WISE		
						DMI	SZ		
				DW					
				KLN					
				WE					









DSM/5-30/82-S/S		packages	carcass dimensions		carcass colours		available in	comments
 x4		carcass	DSM/5-30/82	width	300 mm	BI OLS	<i>Sentima</i> [3]P [4] [7] [9] [12]P TRAFFIC [4-] [5-] [6-] [7-] <i>Classic</i> Dekorado Ledo Melos Rosa Modern Diona Hedar Telesto <i>BRWA</i> FAL KAR POR EKR TAF_MDF	cabinet for bottles with internal drawer drawer on METABOX® blum rails
		doors	570/296-SM 140/296-SM	depth	508 mm	BE WIEL BU WISE		
		drawers	SMR-320M4500 SM-320M4500 x2 SMR-284/296/450 SM-140/296/450 SMW-61/203/450	height	820 mm	DMI SZ DW KLN WE		
DSM/5-30/82-2S/S		packages	carcass dimensions		carcass colours		available in	comments
 x4		carcass	DSM/5-30/82	width	300 mm	BI OLS	<i>Sentima</i> [3]P [4] [7] [9] [12]P TRAFFIC [4-] [5-] [6-] [7-] <i>Classic</i> Dekorado Ledo Melos Rosa Modern Diona Hedar Telesto <i>BRWA</i> FAL KAR POR EKR TAF_MDF	drawer on METABOX® blum rails
		doors	284/296-SM x2 140/296-SM	depth	508 mm	BE WIEL BU WISE		
		drawers	SMR-320M4500 x2 SM-320M4500 SMR-284/296/450 x2 SM-140/296/450	height	820 mm	DMI SZ DW KLN WE		
DSM/5-30/82-S/3S		packages	carcass dimensions		carcass colours		available in	comments
 x4		carcass	DSM/5-30/82	width	300 mm	BI OLS	<i>Sentima</i> [3]P [4] [7] [9] [12]P TRAFFIC [4-] [5-] [6-] [7-] <i>Classic</i> Dekorado Ledo Melos Rosa Modern Diona Hedar Telesto <i>BRWA</i> FAL KAR POR EKR TAF_MDF	drawer on METABOX® blum rails
		doors	284/296-SM 140/296-SM x3	depth	508 mm	BE WIEL BU WISE		
		drawers	SMR-320M4500 SM-320M4500 x3 SMR-284/296/450 SM-140/296/450 x3	height	820 mm	DMI SZ DW KLN WE		
DSM/5-45/82-2S/S		packages	carcass dimensions		carcass colours		available in	comments
 x4		carcass	DSM/5-45/82	width	450 mm	BI OLS	<i>Sentima</i> [3]P [4] [7] [9] [12]P TRAFFIC [4-] [5-] [6-] [7-] <i>Classic</i> Dekorado Ledo Melos Rosa Modern Diona Hedar Telesto <i>BRWA</i> FAL KAR POR EKR TAF_MDF	drawer on METABOX® blum rails
		doors	284/446-SM x2 140/446-SM	depth	508 mm	BE WIEL BU WISE		
		drawers	SMR-320M4500 x2 SM-320M4500 SMR-284/446/450 x2 SM-140/446/450	height	820 mm	DMI SZ DW KLN WE		
DSM/5-45/82-S/3S		packages	carcass dimensions		carcass colours		available in	comments
 x4		carcass	DSM/5-45/82	width	450 mm	BI OLS	<i>Sentima</i> [3]P [4] [7] [9] [12]P TRAFFIC [4-] [5-] [6-] [7-] <i>Classic</i> Dekorado Ledo Melos Rosa Modern Diona Hedar Telesto <i>BRWA</i> FAL KAR POR EKR TAF_MDF	drawer on METABOX® blum rails
		doors	284/446-SM 140/446-SM x3	depth	508 mm	BE WIEL BU WISE		
		drawers	SMR-320M4500 SM-320M4500 x3 SMR-284/446/450 SM-140/446/450 x3	height	820 mm	DMI SZ DW KLN WE		
DSM/5-60/82-2S/S		packages	carcass dimensions		carcass colours		available in	comments
 x4		carcass	DSM/5-60/82	width	600 mm	BI OLS	<i>Sentima</i> [3]P [4] [7] [9] [12]P TRAFFIC [4-] [5-] [6-] [7-] <i>Classic</i> Dekorado Ledo Melos Rosa Modern Diona Hedar Telesto <i>BRWA</i> FAL KAR POR EKR TAF_MDF	drawer on METABOX® blum rails
		doors	284/596-SM x2 140/596-SM	depth	508 mm	BE WIEL BU WISE		
		drawers	SMR-320M4500 x2 SM-320M4500 SMR-284/596/450 x2 SM-140/596/450	height	820 mm	DMI SZ DW KLN WE		
DSM/5-60/82-S/3S		packages	carcass dimensions		carcass colours		available in	comments
 x4		carcass	DSM/5-60/82	width	600 mm	BI OLS	<i>Sentima</i> [3]P [4] [7] [9] [12]P TRAFFIC [4-] [5-] [6-] [7-] <i>Classic</i> Dekorado Ledo Melos Rosa Modern Diona Hedar Telesto <i>BRWA</i> FAL KAR POR EKR TAF_MDF	drawer on METABOX® blum rails
		doors	284/596-SM 140/596-SM x3	depth	508 mm	BE WIEL BU WISE		
		drawers	SMR-320M4500 SM-320M4500 x3 SMR-284/896/450 x3 SM-140/896/450	height	820 mm	DMI SZ DW KLN WE		
DSM/5-90/82-2S/S		packages	carcass dimensions		carcass colours		available in	comments
 x6		carcass	DSM/5-90/82	width	900 mm	BI OLS	<i>Sentima</i> [3]P [4] [7] [9] [12]P TRAFFIC [4-] [5-] [6-] [7-] <i>Classic</i> Dekorado Ledo Melos Rosa Modern Diona Hedar Telesto <i>BRWA</i> FAL KAR POR EKR TAF_MDF	drawer on METABOX® blum rails
		doors	284/896-SM x2 140/896-SM	depth	508 mm	BE WIEL BU WISE		
		drawers	SMR-320M4500 x2 SM-320M4500 SMR-284/896/450 x2 SM-140/896/450	height	820 mm	DMI SZ DW KLN WE		







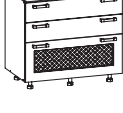

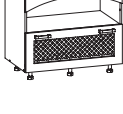
DSM/5-90/82-2SV/S		packages	carcass dimensions		carcass colours		available in	comments
 	carcass	DSM/5-90/82	width	900 mm	BU		<i>Sentima</i> TRAFFIC [3]P [4] [7] [9] [12]P [5-] [6-] [7-]	drawer on METABOX® blum rails * concerns doors, in which glazing is not factory fitted
	doors	284/896-SMV x2 140/896-SM	depth	508 mm	DW OLS			
	drawers	SMR-320M4500 x2 SM-320M4500 SMR-284/896/450 SM-140/896/450	height	820 mm	WIEL			
	glazing	284/896-V* x2						
DSM/5-90/82-S/3S		packages	carcass dimensions		carcass colours		available in	comments
 	carcass	DSM/5-90/82	width	900 mm	BI OLS		<i>Sentima</i> TRAFFIC [3]P [4] [7] [9] [12]P <i>Classic</i> [4-] [5-] [6-] [7-] <i>Modern</i> Dekorado Ledo Melos Rosa <i>BRW</i> Diona Hedar Telesto FAL KAR POR EKR TAF_MDF	drawer on METABOX® blum rails
	doors	284/896-SM 140/896-SM x3	depth	508 mm	BE WIEL BU WISE			
	drawers	SMR-320M4500 SM-320M4500 x3 SMR-284/896/450 SM-140/896/450 x3	height	820 mm	DMI SZ DW KLN WE			
	glazing							
DSM/5-90/82-SV/3S		packages	carcass dimensions		carcass colours		available in	comments
 	carcass	DSM/5-90/82	width	900 mm	BU		<i>Sentima</i> TRAFFIC [3]P [4] [7] [9] [12]P [5-] [6-] [7-]	drawer on METABOX® blum rails * concerns doors, in which glazing is not factory fitted
	doors	284/896-SMV 140/896-SM x3	depth	508 mm	DW OLS			
	drawers	SMR-320M4500 SM-320M4500 x3 SMR-284/896/450 SM-140/896/450 x3	height	820 mm	WIEL			
	glazing	284/896-V*						
DBSM/5-90/82-SV/B		packages	carcass dimensions		carcass colours		available in	comments
 	carcass	DBSMST/5-90/82	width	900 mm	BU		<i>Sentima</i> [4] [7] [12]P	drawer on METABOX® blum rails * concerns doors, in which glazing is not factory fitted
	doors	284/896-SMV 140/896-E	depth	508 mm	DW OLS			
	drawer	SMR-320M4500 SMR-284/896/450	height	820 mm	WIEL			
	glazing	284/896-V*						
DSM/5-45/136-5S		packages	carcass dimensions		carcass colours		available in	comments
 	carcass	DSM/5-45/136	width	450 mm	BU		<i>Sentima</i> TRAFFIC [3]P [4] [7] [9] [12]P [4-] [5-] [6-] [7-]	drawer on METABOX® blum rails
	doors	250/446-SM x5	depth	560 mm	DW OLS			
	drawers	SM-320K4500 x5 SM-250,284/446/450 x5	height	1364 mm	WIEL			
	glazing							
DSM/5-45/136-5SV		packages	carcass dimensions		carcass colours		available in	comments
 	carcass	DSM/5-45/136	width	450 mm	BU		<i>Sentima</i> TRAFFIC [3]P [4] [7] [9] [12]P [5-] [6-] [7-]	drawer on METABOX® blum rails * concerns doors, in which glazing is not factory fitted
	doors	250/446-SM x5	depth	560 mm	DW OLS			
	drawers	SM-320K4500 x5 SM-250,284/446/450 x5	height	1364 mm	WIEL			
	glazing							

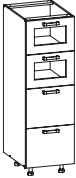

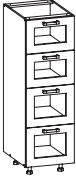



















D1ST/4-30/82-L/S		packages	carcass dimensions		carcass colours	available in	comments	
		carcass	D1ST/4-30/82	width	300 mm	KA	<i>Royal</i> [11] [22] [25]	TANDEMBOX® drawers with guides and BLUMOTION® blum shock absorber system
		doors	534/296 (-L) 176/296-ST	depth	508 mm	KAS		
		drawer	DS-30-N-KOR	height	820 mm			
D1ST/4-30/82-P/S		packages	carcass dimensions		carcass colours	available in	comments	
		carcass	D1ST/4-30/82	width	300 mm	KA	<i>Royal</i> [11] [22] [25]	TANDEMBOX® drawers with guides and BLUMOTION® blum shock absorber system
		doors	534/296 (-P) 176/296-ST	depth	508 mm	KAS		
		drawer	DS-30-N-KOR	height	820 mm			
D1ST/4-45/82-L/S		packages	carcass dimensions		carcass colours	available in	comments	
		carcass	D1ST/4-45/82	width	450 mm	KA	<i>Royal</i> [11] [22] [25]	TANDEMBOX® drawers with guides and BLUMOTION® blum shock absorber system
		doors	534/446 (-L) 176/446-ST	depth	508 mm	KAS		
		drawer	DS-45-N-KOR	height	820 mm			
D1ST/4-45/82-P/S		packages	carcass dimensions		carcass colours	available in	comments	
		carcass	D1ST/4-45/82	width	450 mm	KA	<i>Royal</i> [11] [22] [25]	TANDEMBOX® drawers with guides and BLUMOTION® blum shock absorber system
		doors	534/446 (-P) 176/446-ST	depth	508 mm	KAS		
		drawer	DS-45-N-KOR	height	820 mm			
D1ST/4-60/82-L/S		packages	carcass dimensions		carcass colours	available in	comments	
		carcass	D1ST/4-60/82	width	600 mm	KA	<i>Royal</i> [11] [22] [25]	TANDEMBOX® drawers with guides and BLUMOTION® blum shock absorber system
		doors	534/596 (-L) 176/596-ST	depth	508 mm	KAS		
		drawer	DS-60-N-KOR	height	820 mm			
D1ST/4-60/82-P/S		packages	carcass dimensions		carcass colours	available in	comments	
		carcass	D1ST/4-60/82	width	600 mm	KA	<i>Royal</i> [11] [22] [25]	TANDEMBOX® drawers with guides and BLUMOTION® blum shock absorber system
		doors	534/596 (-P) 176/596-ST	depth	508 mm	KAS		
		drawer	DS-60-N-KOR	height	820 mm			
DST/4-30/82-S/S		packages	carcass dimensions		carcass colours	available in	comments	
		carcass	DST/4-30/82	width	300 mm	KA	<i>Royal</i> [11] [22] [25]	cabinet for bottles with internal drawer TANDEMBOX® drawers with guides and BLUMOTION® blum shock absorber system
		doors	543/296-ST 176/296-ST	depth	508 mm	KAS		
		drawers	DS-30-W-KOR DS-30-N-KOR x2 DSWT-30-N-FRN	height	820 mm			
DST/4-30/82-2S		packages	carcass dimensions		carcass colours	available in	comments	
		carcass	DST/4-30/82	width	300 mm	KA	<i>Royal</i> [11] [22] [25]	TANDEMBOX® drawers with guides and BLUMOTION® blum shock absorber system
		doors	355/296-ST x2	depth	508 mm	KAS		
		drawers	DS-30-W-KOR x2	height	820 mm			

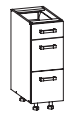







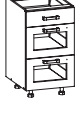







DST/4-30/82-S/2S		packages	carcass dimensions		carcass colours		available in	comments	
		carcass	DST/4-30/82	width	300 mm	KA	Royal	[11] [22] [25]	TANDEMBOX® drawers with guides and BLUMOTION® blum shock absorber system
		doors	355/296-ST 176/296-ST x2	depth	508 mm	KAS			
		drawers	DS-30-W-KOR DS-30-N-KOR x2	height	820 mm				
DST/4-30/82-4S		packages	carcass dimensions		carcass colours		available in	comments	
		carcass	DST/4-30/82	width	300 mm	KA	Royal	[11] [22] [25]	TANDEMBOX® drawers with guides and BLUMOTION® blum shock absorber system
		doors	176/296-ST x4	depth	508 mm	KAS			
		drawers	DS-30-N-KOR x4	height	820 mm				
DST/4-45/82-2S		packages	carcass dimensions		carcass colours		available in	comments	
		carcass	DST/4-45/82	width	450 mm	KA	Royal	[11] [22] [25]	TANDEMBOX® drawers with guides and BLUMOTION® blum shock absorber system
		doors	355/446-ST x2	depth	508 mm	KAS			
		drawers	DS-45-W-KOR x2	height	820 mm				
DST/4-45/82-2SV		packages	carcass dimensions		carcass colours		available in	comments	
		carcass	DST/4-45/82	width	450 mm	KA	Royal	[11] [22] [25]	TANDEMBOX® drawers with guides and BLUMOTION® blum shock absorber system
		doors	355/446-STV x2	depth	508 mm	KAS			
		drawers	DS-45-W-KOR x2	height	820 mm				
DST/4-45/82-2SH		packages	carcass dimensions		carcass colours		available in	comments	
		carcass	DST/4-45/82	width	450 mm	KA	Royal	[11] [22] [25]	TANDEMBOX® drawers with guides and BLUMOTION® blum shock absorber system
		doors	355/446-STH x2	depth	508 mm	KAS			
		drawers	DS-45-W-KOR x2	height	820 mm				
DST/4-45/82-S/2S		packages	carcass dimensions		carcass colours		available in	comments	
		carcass	DST/4-45/82	width	450 mm	KA	Royal	[11] [22] [25]	TANDEMBOX® drawers with guides and BLUMOTION® blum shock absorber system
		doors	355/446-ST 176/446-ST x2	depth	508 mm	KAS			
		drawers	DS-45-KOR DS-45-N-KOR x2	height	820 mm				
DST/4-45/82-SV/2S		packages	carcass dimensions		carcass colours		available in	comments	
		carcass	DST/4-45/82	width	450 mm	KA	Royal	[11] [22] [25]	TANDEMBOX® drawers with guides and BLUMOTION® blum shock absorber system
		doors	355/446-STV 176/446-ST x2	depth	508 mm	KAS			
		drawers	DS-45-W-KOR DS-45-N-KOR x2	height	820 mm				
DST/4-45/82-SH/2S		packages	carcass dimensions		carcass colours		available in	comments	
		carcass	DST/4-45/82	width	450 mm	KA	Royal	[11] [22] [25]	TANDEMBOX® drawers with guides and BLUMOTION® blum shock absorber system
		doors	355/446-STH 176/446-ST x2	depth	508 mm	KAS			
		drawers	DS-45-W-KOR DS-45-N-KOR x2	height	820 mm				

























DST/4-45/82-4S		packages	carcass dimensions		carcass colours	available in	comments	
		carcass	DST/4-45/82	width	450 mm	KA KAS	<i>Royal</i> [11] [22] [25]	TANDEMBOX® drawers with guides and BLUMOTION® blum shock absorber system
		doors	176/446-ST x4	depth	508 mm			
		drawers	DS-45-N-KOR x4	height	820 mm			
DST/4-60/82-2S		packages	carcass dimensions		carcass colours	available in	comments	
		carcass	DST/4-60/82	width	600 mm	KA KAS	[11] [22] [25]	TANDEMBOX® drawers with guides and BLUMOTION® blum shock absorber system
		doors	355/596-ST x2	depth	508 mm			
		drawers	DS-60-W-KOR x2	height	820 mm			
DST/4-60/82-2SV		packages	carcass dimensions		carcass colours	available in	comments	
		carcass	DST/4-60/82	width	600 mm	KA KAS	[11] [22] [25]	TANDEMBOX® drawers with guides and BLUMOTION® blum shock absorber system
		doors	355/596-STV x2	depth	508 mm			
		drawers	DS-60-W-KOR x2	height	820 mm			
DST/4-60/82-2SH		packages	carcass dimensions		carcass colours	available in	comments	
		carcass	DST/4-60/82	width	600 mm	KA KAS	[11] [22] [25]	TANDEMBOX® drawers with guides and BLUMOTION® blum shock absorber system
		doors	355/596-STH x2	depth	508 mm			
		drawers	DS-60-W-KOR x2	height	820 mm			
DST/4-60/82-S/2S		packages	carcass dimensions		carcass colours	available in	comments	
		carcass	DST/4-60/82	width	600 mm	KA KAS	[11] [22] [25]	TANDEMBOX® drawers with guides and BLUMOTION® blum shock absorber system
		doors	355/596-ST 176/596-ST x2	depth	508 mm			
		drawers	DS-60-W-KOR DS-60-N-KOR x2	height	820 mm			
DST/4-60/82-SV/2S		packages	carcass dimensions		carcass colours	available in	comments	
		carcass	DST/4-60/82	width	600 mm	KA KAS	[11] [22] [25]	TANDEMBOX® drawers with guides and BLUMOTION® blum shock absorber system
		doors	355/596-STV 176/596-ST x2	depth	508 mm			
		drawers	DS-60-W-KOR DS-60-N-KOR x2	height	820 mm			
DST/4-60/82-SH/2S		packages	carcass dimensions		carcass colours	available in	comments	
		carcass	DST/4-60/82	width	600 mm	KA KAS	[11] [22] [25]	TANDEMBOX® drawers with guides and BLUMOTION® blum shock absorber system
		doors	355/596-STH 176/596-ST x2	depth	508 mm			
		drawers	DS-60-W-KOR DS-60-N-KOR x2	height	820 mm			
DST/4-60/82-4S		packages	carcass dimensions		carcass colours	available in	comments	
		carcass	DST/4-60/82	width	600 mm	KA KAS	[11] [22] [25]	TANDEMBOX® drawers with guides and BLUMOTION® blum shock absorber system
		doors	176/596-ST x4	depth	508 mm			
		drawers	DS-60-N-KOR x4	height	820 mm			

DST/4-90/82-2S		packages	carcass dimensions		carcass colours		available in	comments	
		carcass	DST/4-90/82	width	900 mm	KA	<i>Royal</i>	[11] [22] [25]	TANDEMBOX® drawers with guides and BLUMOTION® blum shock absorber system
		doors	355/896-ST x2	depth	508 mm	KAS			
		drawers	DS-90-W-KOR x2	height	820 mm				
DST/4-90/82-2SV		packages	carcass dimensions		carcass colours		available in	comments	
		carcass	DST/4-90/82	width	900 mm	KA	<i>Royal</i>	[11] [22] [25]	TANDEMBOX® drawers with guides and BLUMOTION® blum shock absorber system
		doors	355/896-STV x2	depth	508 mm	KAS			
		drawers	DS-90-W-KOR x2	height	820 mm				
DST/4-90/82-2SH		packages	carcass dimensions		carcass colours		available in	comments	
		carcass	DST/4-90/82	width	900 mm	KA	<i>Royal</i>	[11] [22] [25]	TANDEMBOX® drawers with guides and BLUMOTION® blum shock absorber system
		doors	355/896-STH x2	depth	508 mm	KAS			
		drawers	DS-90-W-KOR x2	height	820 mm				
DST/4-90/82-S/2S		packages	carcass dimensions		carcass colours		available in	comments	
		carcass	DST/4-90/82	width	900 mm	KA	<i>Royal</i>	[11] [22] [25]	TANDEMBOX® drawers with guides and BLUMOTION® blum shock absorber system
		doors	355/896-STV 176/896-ST x2	depth	508 mm	KAS			
		drawers	DS-90-W-KOR DS-90-N-KOR x2	height	820 mm				
DST/4-90/82-SV/2S		packages	carcass dimensions		carcass colours		available in	comments	
		carcass	DST/4-90/82	width	900 mm	KA	<i>Royal</i>	[11] [22] [25]	TANDEMBOX® drawers with guides and BLUMOTION® blum shock absorber system
		doors	355/896-STV 176/896-ST x2	depth	508 mm	KAS			
		drawers	DS-90-W-KOR DS-90-N-KOR x2	height	820 mm				
DST/4-90/82-SH/2S		packages	carcass dimensions		carcass colours		available in	comments	
		carcass	DST/4-90/82	width	900 mm	KA	<i>Royal</i>	[11] [22] [25]	TANDEMBOX® drawers with guides and BLUMOTION® blum shock absorber system
		doors	355/896-STH 176/896-ST x2	depth	508 mm	KAS			
		drawers	DS-90-W-KOR DS-90-N-KOR x2	height	820 mm				
DBST/4-90/82-SV/B		packages	carcass dimensions		carcass colours		available in	comments	
		carcass	DBSMST/4-90/82	width	900 mm	KA	<i>Royal</i>	[11] [22] [25]	TANDEMBOX® drawers with guides and BLUMOTION® blum shock absorber system
		doors	355/896-STV 176/896-E	depth	508 mm	KAS			
		drawer	DS-90-W-KOR	height	820 mm				
DBST/4-90/82-SH/B		packages	carcass dimensions		carcass colours		available in	comments	
		carcass	DBSMST/4-90/82	width	900 mm	KA	<i>Royal</i>	[11] [22] [25]	TANDEMBOX® drawers with guides and BLUMOTION® blum shock absorber system
		doors	355/896-STH 176/896-E	depth	508 mm	KAS			
		drawer	DS-90-W-KOR	height	820 mm				



		packages	carcass dimensions	carcass colours	available in	comments	
4		carcass	DST/4-45/143	width 450 mm	KA	Royal [11] [22] [25]	TANDEMBOX® drawers with guides and BLUMOTION® blum shock absorber system
		doors	355/446-ST x2 304/446-STV x2	depth 560 mm	KAS		
		drawers	DS-45-W-KOR x2 DS-45-N-KOR x2	height 1430 mm			
4		carcass	DST/4-45/143	width 450 mm	KA	Royal [11] [22] [25]	TANDEMBOX® drawers with guides and BLUMOTION® blum shock absorber system
		doors	355/446-ST x2 304/446-STH x2	depth 560 mm	KAS		
		drawers	DS-45-W-KOR x2 DS-45-N-KOR x2	height 1430 mm			
4		carcass	DST/4-45/143	width 450 mm	KA	Royal [11] [22] [25]	TANDEMBOX® drawers with guides and BLUMOTION® blum shock absorber system
		doors	355/446-STV x2 304/446-STV x2	depth 560 mm	KAS		
		drawers	DS-45-W-KOR x2 DS-45-N-KOR x2	height 1430 mm			
4		carcass	DST/4-45/143	width 450 mm	KA	Royal [11] [22] [25]	TANDEMBOX® drawers with guides and BLUMOTION® blum shock absorber system
		doors	355/446-STH x2 304/446-STH x2	depth 560 mm	KAS		
		drawers	DS-45-W-KOR x2 DS-45-N-KOR x2	height 1430 mm			
5		carcass	D1ST/5-30/82	width 300 mm	BI WIEL	Royal [14] [15] [16] CAPITAL [34] [35] [36]	TANDEMBOX® drawers with guides and BLUMOTION® blum shock absorber system
		doors	570/296 (-L) 140/296-ST	depth 508 mm	BE WISE		
		drawer	DS-30-N-KOR	height 820 mm	DMI WISP DW SZ KLN WE OLS	Classic Dekorado Ledo Melos Rosa Modern Diona Hedar Telesto BRW FAL KAR POR EKR TAF_MDF	
5		carcass	D1ST/5-30/82	width 300 mm	BI WIEL	Royal [14] [15] [16] CAPITAL [34] [35] [36]	TANDEMBOX® drawers with guides and BLUMOTION® blum shock absorber system
		doors	570/296 (-P) 140/296-ST	depth 508 mm	BE WISE		
		drawer	DS-30-N-KOR	height 820 mm	DMI WISP DW SZ KLN WE OLS	Classic Dekorado Ledo Melos Rosa Modern Diona Hedar Telesto BRW FAL KAR POR EKR TAF_MDF	
5		carcass	D1ST/5-45/82	width 450 mm	BI WIEL	Royal [14] [15] [16] CAPITAL [34] [35] [36]	TANDEMBOX® drawers with guides and BLUMOTION® blum shock absorber system
		doors	570/446 (-L) 140/446-ST	depth 508 mm	BE WISE		
		drawer	DS-45-N-KOR	height 820 mm	DMI WISP DW SZ KLN WE OLS	Classic Dekorado Ledo Melos Rosa Modern Diona Hedar Telesto BRW FAL KAR POR EKR TAF_MDF	
5		carcass	D1ST/5-45/82	width 450 mm	BI WIEL	Royal [14] [15] [16] CAPITAL [34] [35] [36]	TANDEMBOX® drawers with guides and BLUMOTION® blum shock absorber system
		doors	570/446 (-P) 140/446-ST	depth 508 mm	BE WISE		
		drawer	DS-45-N-KOR	height 820 mm	DMI WISP DW SZ KLN WE OLS	Classic Dekorado Ledo Melos Rosa Modern Diona Hedar Telesto BRW FAL KAR POR EKR TAF_MDF	







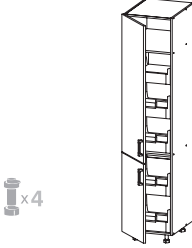

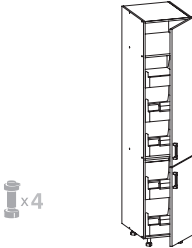

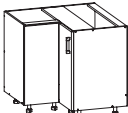

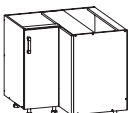

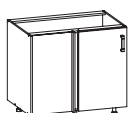
D1ST/5-60/82-L/S		packages	carcass dimensions		carcass colours		available in	comments	
 		carcass	D1ST/5-60/82	width	600 mm	BI WIEL	<i>Royal</i>	[14] [15] [16]	TANDEMBOX [®] drawers with guides and BLUMOTION [®] blum shock absorber system
		doors	570/596 (-L) 140/596-ST	depth	508 mm	BE WISE	CAPITAL	[34] [35] [36]	
		drawer	DS-60-N-KOR	height	820 mm	DMI WISP	<i>Classic</i>	<i>Dekorado Ledo Melos Rosa</i>	
						DW SZ	Modern	Diona Hedar Telesto	
						KLN	<i>BRW</i>	FAL KAR POR EKR TAF_MDF	
						WE			
						OLS			
D1ST/5-60/82-P/S		packages	carcass dimensions		carcass colours		available in	comments	
 		carcass	D1ST/5-60/82	width	600 mm	BI WIEL	<i>Royal</i>	[14] [15] [16]	TANDEMBOX [®] drawers with guides and BLUMOTION [®] blum shock absorber system
		doors	570/596 (-P) 140/596-ST	depth	508 mm	BE WISE	CAPITAL	[34] [35] [36]	
		drawer	DS-60-N-KOR	height	820 mm	DMI WISP	<i>Classic</i>	<i>Dekorado Ledo Melos Rosa</i>	
						DW SZ	Modern	Diona Hedar Telesto	
						KLN	<i>BRW</i>	FAL KAR POR EKR TAF_MDF	
						WE			
						OLS			
D1ST/5-60/82-L/P/S		packages	carcass dimensions		carcass colours		available in	comments	
 		carcass	D1ST/5-60/82	width	600 mm	BI WIEL	<i>Royal</i>	[14] [15] [16]	TANDEMBOX [®] drawers with guides and BLUMOTION [®] blum shock absorber system
		doors	570/296 (-L) 570/296 (-P) 140/596-ST	depth	508 mm	BE WISE	CAPITAL	[34] [35] [36]	
		drawer	DS-60-N-KOR	height	820 mm	DMI WISP	<i>Classic</i>		
						DW SZ	Modern		
						KLN	<i>BRW</i>		
						WE			
						OLS			
DST/5-30/82-S/S		packages	carcass dimensions		carcass colours		available in	comments	
 		carcass	DST/5-30/82	width	300 mm	BI WIEL	<i>Royal</i>	[14] [15] [16]	cabinet for bottles with internal drawer TANDEMBOX [®] drawers with guides and BLUMOTION [®] blum shock absorber system
		doors	570/296-ST 140/296-ST	depth	508 mm	BE WISE	CAPITAL	[34] [35] [36]	
		drawers	DS-30-W-KOR DS-30-N-KOR x2 DSWT-30-N-FRN	height	820 mm	DMI WISP	<i>Classic</i>	<i>Dekorado Ledo Melos Rosa</i>	
						DW SZ	Modern	Diona Hedar Telesto	
						KLN	<i>BRW</i>	FAL KAR POR EKR TAF_MDF	
						WE			
						OLS			
DST/5-30/82-2S/S		packages	carcass dimensions		carcass colours		available in	comments	
 		carcass	DST/5-30/82	width	300 mm	BI WIEL	<i>Royal</i>	[14] [15] [16]	TANDEMBOX [®] drawers with guides and BLUMOTION [®] blum shock absorber system
		doors	284/296-ST x2 140/296-ST	depth	508 mm	BE WISE	CAPITAL	[34] [35] [36]	
		drawers	DS-30-W-KOR x2 DS-30-N-KOR	height	820 mm	DMI WISP	<i>Classic</i>	<i>Dekorado Ledo Melos Rosa</i>	
						DW SZ	Modern	Diona Hedar Telesto	
						KLN	<i>BRW</i>	FAL KAR POR EKR TAF_MDF	
						WE			
						OLS			
DST/5-30/82-S/3S		packages	carcass dimensions		carcass colours		available in	comments	
 		carcass	DST/5-30/82	width	300 mm	BI WIEL	<i>Royal</i>	[14] [15] [16]	TANDEMBOX [®] drawers with guides and BLUMOTION [®] blum shock absorber system
		doors	284/296-ST 140/296-ST x3	depth	508 mm	BE WISE	CAPITAL	[34] [35] [36]	
		drawers	DS-30-W-KOR DS-30-N-KOR x3	height	820 mm	DMI WISP	<i>Classic</i>	<i>Dekorado Ledo Melos Rosa</i>	
						DW SZ	Modern	Diona Hedar Telesto	
						KLN	<i>BRW</i>	FAL KAR POR EKR TAF_MDF	
						WE			
						OLS			
DST/5-45/82-2S/S		packages	carcass dimensions		carcass colours		available in	comments	
 		carcass	DST/5-45/82	width	450 mm	BI WIEL	<i>Royal</i>	[14] [15] [16]	TANDEMBOX [®] drawers with guides and BLUMOTION [®] blum shock absorber system
		doors	284/446-ST x2 140/446-ST	depth	508 mm	BE WISE	CAPITAL	[34] [35] [36]	
		drawers	DS-45-W-KOR x2 DS-45-N-KOR	height	820 mm	DMI WISP	<i>Classic</i>	<i>Dekorado Ledo Melos Rosa</i>	
						DW SZ	Modern	Diona Hedar Telesto	
						KLN	<i>BRW</i>	FAL KAR POR EKR TAF_MDF	
						WE			
						OLS			
DST/5-45/82-2SV/S		packages	carcass dimensions		carcass colours		available in	comments	
 		carcass	DST/5-45/82	width	450 mm	DW	<i>Royal</i>	[14] [15] [16]	TANDEMBOX [®] drawers with guides and BLUMOTION [®] blum shock absorber system
		doors	284/446-STV x2 140/446-ST	depth	508 mm	OLS	CAPITAL	[34] [35]	
		drawers	DS-45-W-KOR x2 DS-45-N-KOR	height	820 mm	WISE	<i>Classic</i>		
						WISP	Modern		
							<i>BRW</i>		

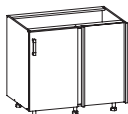













DST/5-45/82-2SH/S		packages	carcass dimensions		carcass colours		available in	comments	
		carcass	DST/5-45/82	width	450 mm	DW	Royal	[15] [16]	TANDEMBOX® drawers with guides and BLUMOTION® blum shock absorber system
		doors	284/446-STH x2 140/446-ST	depth	508 mm	OLS			
		drawers	DS-45-W-KOR x2 DS-45-N-KOR	height	820 mm				
DST/5-45/82-S/3S		packages	carcass dimensions		carcass colours		available in	comments	
		carcass	DST/5-45/82	width	450 mm	BI WIEL	Royal CAPITAL Classic Modern BRW	[14] [15] [16] [34] [35] [36]	TANDEMBOX® drawers with guides and BLUMOTION® blum shock absorber system
		doors	284/446-ST 140/446-ST x3	depth	508 mm	BE WISE			
		drawers	DS-45-W-KOR DS-45-N-KOR x3	height	820 mm	DMI WISP DW SZ KLN WE OLS			
		carcass	DST/5-45/82	width	450 mm	DW	Royal CAPITAL	[14] [15] [16] [34] [35]	TANDEMBOX® drawers with guides and BLUMOTION® blum shock absorber system
		doors	284/446-STV 140/446-ST x3	depth	508 mm	OLS			
		drawers	DS-45-W-KOR DS-45-N-KOR x3	height	820 mm	WISE WISP			
DST/5-45/82-SH/3S		packages	carcass dimensions		carcass colours		available in	comments	
		carcass	DST/5-45/82	width	450 mm	DW	Royal	[15] [16]	TANDEMBOX® drawers with guides and BLUMOTION® blum shock absorber system
		doors	284/446-STH 140/446-ST x3	depth	508 mm	OLS			
		drawers	DS-45-W-KOR DS-45-N-KOR x3	height	820 mm				
DST/5-60/82-2S/S		packages	carcass dimensions		carcass colours		available in	comments	
		carcass	DST/5-60/82	width	600 mm	BI WIEL	Royal CAPITAL Classic Modern BRW	[14] [15] [16] [34] [35] [36]	TANDEMBOX® drawers with guides and BLUMOTION® blum shock absorber system
		doors	284/596-ST x2 140/596-ST	depth	508 mm	BE WISE			
		drawers	DS-60-W-KOR x2 DS-60-N-KOR	height	820 mm	DMI WISP DW SZ KLN WE OLS			
DST/5-60/82-2SV/S		packages	carcass dimensions		carcass colours		available in	comments	
		carcass	DST/5-60/82	width	600 mm	DW	Royal CAPITAL	[14] [15] [16] [34] [35]	TANDEMBOX® drawers with guides and BLUMOTION® blum shock absorber system
		doors	284/596-STV x2 140/596-ST	depth	508 mm	OLS			
		drawers	DS-60-W-KOR x2 DS-60-N-KOR	height	820 mm	WISE WISP			
DST/5-60/82-2SH/S		packages	carcass dimensions		carcass colours		available in	comments	
		carcass	DST/5-60/82	width	600 mm	DW	Royal	[15] [16]	TANDEMBOX® drawers with guides and BLUMOTION® blum shock absorber system
		doors	284/596-STH x2 140/596-ST	depth	508 mm	OLS			
		drawers	DS-60-W-KOR x2 DS-60-N-KOR	height	820 mm				
DST/5-60/82-S/3S		packages	carcass dimensions		carcass colours		available in	comments	
		carcass	DST/5-60/82	width	600 mm	BI WIEL	Royal CAPITAL Classic Modern BRW	[14] [15] [16] [34] [35] [36]	TANDEMBOX® drawers with guides and BLUMOTION® blum shock absorber system
		doors	284/596-ST 140/596-ST x3	depth	508 mm	BE WISE			
		drawers	DS-60-W-KOR DS-60-N-KOR x3	height	820 mm	DMI WISP DW SZ KLN WE OLS			

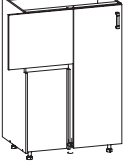

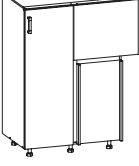

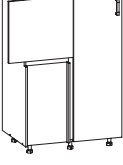

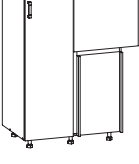







DST/5-60/82-SV/3S		packages	carcass dimensions		carcass colours		available in	comments	
 		carcass	DST/5-60/82	width	600 mm	DW	Royal CAPITAL	[14] [15] [16] [34] [35]	TANDEMBOX® drawers with guides and BLUMOTION® blum shock absorber system
		doors	284/596-STV 140/596-ST x3	depth	508 mm	OLS			
		drawers	DS-60-W-KOR DS-60-N-KOR x3	height	820 mm	WISE WISP			
DST/5-60/82-SH/3S		packages	carcass dimensions		carcass colours		available in	comments	
 		carcass	DST/5-60/82	width	600 mm	DW	Royal	[15] [16]	TANDEMBOX® drawers with guides and BLUMOTION® blum shock absorber system
		doors	284/596-STH 140/596-ST x3	depth	508 mm	OLS			
		drawers	DS-60-W-KOR DS-60-N-KOR x3	height	820 mm				
DST/5-90/82-2S/S		packages	carcass dimensions		carcass colours		available in	comments	
 		carcass	DST/5-90/82	width	900 mm	BI WIEL	Royal CAPITAL <i>Classic</i> Modern <i>BRW</i>	[14] [15] [16] [34] [35] [36]	TANDEMBOX® drawers with guides and BLUMOTION® blum shock absorber system
		doors	284/896-ST x2 140/896-ST	depth	508 mm	BE WISE DMI WISP			
		drawers	DS-90-W-KOR x2 DS-90-N-KOR	height	820 mm	DW SZ KLN WE OLS			
 		carcass	DST/5-90/82	width	900 mm	DW	Royal CAPITAL	[14] [15] [16] [34] [35]	TANDEMBOX® drawers with guides and BLUMOTION® blum shock absorber system
		doors	284/896-STV x2 140/896-ST	depth	508 mm	OLS			
		drawers	DS-90-W-KOR x2 DS-90-N-KOR	height	820 mm	WISE WISP			
DST/5-90/82-2SH/S		packages	carcass dimensions		carcass colours		available in	comments	
 		carcass	DST/5-90/82	width	900 mm	DW	Royal	[15] [16]	TANDEMBOX® drawers with guides and BLUMOTION® blum shock absorber system
		doors	284/896-STH x2 140/896-ST	depth	508 mm	OLS			
		drawers	DS-90-W-KOR x2 DS-90-N-KOR	height	820 mm				
DST/5-90/82-S/3S		packages	carcass dimensions		carcass colours		available in	comments	
 		carcass	DST/5-90/82	width	900 mm	BI WIEL	Royal CAPITAL <i>Classic</i> Modern <i>BRW</i>	[14] [15] [16] [34] [35] [36]	TANDEMBOX® drawers with guides and BLUMOTION® blum shock absorber system
		doors	284/896-ST 140/896-ST x3	depth	508 mm	BE WISE DMI WISP			
		drawers	DS-90-W-KOR DS-90-N-KOR x3	height	820 mm	DW SZ KLN WE OLS			
DST/5-90/82-SV/3S		packages	carcass dimensions		carcass colours		available in	comments	
 		carcass	DST/5-90/82	width	900 mm	DW	Royal CAPITAL	[14] [15] [16] [34] [35]	TANDEMBOX® drawers with guides and BLUMOTION® blum shock absorber system
		doors	284/896-ST 140/896-ST x3	depth	508 mm	OLS			
		drawers	DS-90-W-KOR DS-90-N-KOR x3	height	820 mm	WISE WISP			
DST/5-90/82-SH/3S		packages	carcass dimensions		carcass colours		available in	comments	
 		carcass	DST/5-90/82	width	900 mm	DW	Royal	[15] [16]	TANDEMBOX® drawers with guides and BLUMOTION® blum shock absorber system
		doors	284/896-ST 140/896-ST x3	depth	508 mm	OLS			
		drawers	DS-90-W-KOR DS-90-N-KOR x3	height	820 mm				



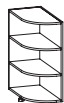

DST/5-120/82-2S/S		packages	carcass dimensions		carcass colours		available in	comments
		carcass	DST/5-120/82	width	1200 mm	WISE	CAPITAL [34] [35] [36]	TANDEMBOX ® drawers with guides and BLUMOTION ® blum shock absorber system
		doors	284/1196-ST x2 140/1196-ST	depth	508 mm	WISP		
		drawers	DS-120-W-KOR x2 DS-120-N-KOR	height	820 mm			
DST/5-120/82-2SV/S		packages	carcass dimensions		carcass colours		available in	comments
		carcass	DST/5-120/82	width	1200 mm	WISE	CAPITAL [34] [35]	TANDEMBOX ® drawers with guides and BLUMOTION ® blum shock absorber system
		doors	284/1196-STV x2 140/1196-ST	depth	508 mm	WISP		
		drawers	DS-120-W-KOR x2 DS-120-N-KOR	height	820 mm			
DST/5-120/82-S/3S		packages	carcass dimensions		carcass colours		available in	comments
		carcass	DST/5-120/82	width	1200 mm	WISE	CAPITAL [34] [35] [36]	TANDEMBOX ® drawers with guides and BLUMOTION ® blum shock absorber system
		doors	284/1196-ST 140/1196-ST x3	depth	508 mm	WISP		
		drawers	DS-120-W-KOR DS-120-N-KOR x3	height	820 mm			
DST/5-120/82-SV/3S		packages	carcass dimensions		carcass colours		available in	comments
		carcass	DST/5-120/82	width	1200 mm	WISE	CAPITAL [34] [35]	TANDEMBOX ® drawers with guides and BLUMOTION ® blum shock absorber system
		doors	284/1196-STV 140/1196-ST x3	depth	508 mm	WISP		
		drawers	DS-120-W-KOR DS-120-N-KOR x3	height	820 mm			
DBST/5-90/82-SH/B		packages	carcass dimensions		carcass colours		available in	comments
		carcass	DBSMST/5-90/82	width	900 mm	OLS	<i>Royal</i> [15]	TANDEMBOX ® drawers with guides and BLUMOTION ® blum shock absorber system
		doors	284/896-STH 140/896-E	depth	508 mm			
		drawer	DS-90-W-KOR	height	820 mm			
DBST/5-90/82-SV/B		packages	carcass dimensions		carcass colours		available in	comments
		carcass	DBSMST/5-90/82	width	900 mm	OLS	<i>Royal</i> [14] [15]	TANDEMBOX ® drawers with guides and BLUMOTION ® blum shock absorber system
		doors	284/896-STV 140/896-E	depth	508 mm	WISP		
		drawer	DS-90-W-KOR	height	820 mm			
DST/5-45/136-5S		packages	carcass dimensions		carcass colours		available in	comments
		carcass	DST/5-45/136	width	450 mm	DW	<i>Royal</i> CAPITAL [14] [15] [16] [34] [35] [36]	TANDEMBOX ® drawers with guides and BLUMOTION ® blum shock absorber system
		doors	250/446-ST x5	depth	560 mm	OLS		
		drawers	DS-45-S-KOR x5	height	1364 mm	WISE WISP		
DST/5-45/136-5SV		packages	carcass dimensions		carcass colours		available in	comments
		carcass	DST/5-45/136	width	450 mm	DW	<i>Royal</i> CAPITAL [14] [15] [16] [34] [35]	TANDEMBOX ® drawers with guides and BLUMOTION ® blum shock absorber system
		doors	250/446-STV x5	depth	560 mm	OLS		
		drawers	DS-45-S-KOR x5	height	1364 mm	WISE WISP		



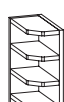

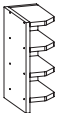

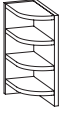

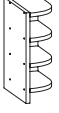





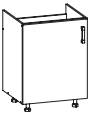

DST/5-45/136-5SH		packages	carcass dimensions	carcass colours	available in	comments
	carcass	DST/5-45/136	width 450 mm	DW	<i>Royal</i> [15] [16]	TANDEMBOX® drawers with guides and BLUMOTION® blum shock absorber system
	doors	250/446-STH x5	depth 560 mm	OLS		
	drawers	DS-45-S-KOR x5	height 1364 mm			
DSWT/5-45/207-L/L		packages	carcass dimensions	carcass colours	available in	comments
	carcass	DSWT/5-45/207	width 450 mm	BI WIEL	<i>Royal</i> CAPITAL <i>Classic</i> Modern 	TANDEMBOX® drawers with guides and BLUMOTION® blum shock absorber system
	doors	713/446-LSW 1247/446-LSW	depth 560 mm	BE WISE		
	drawers	DS-45-W-KOR x4 DS-45-S-KOR DSWT-45-W-FRN x4 DSWT-45-S-FRN	height 2066 mm	DMI WISP DW SZ KLN WE OLS		
	carcass	DSWT/5-45/207	width 450 mm	BI WIEL	[11] [22] [25] [14] [15] [16] [34] [35] [36]	TANDEMBOX® drawers with guides and BLUMOTION® blum shock absorber system
	doors	713/446-PSW 1247/446-PSW	depth 560 mm	BE WISE		
	drawers	DS-45-W-KOR x4 DS-45-S-KOR DSWT-45-FRN x4 DSWT-45-S-FRN	height 2066 mm	DMI WISP DW SZ KLN WE OLS		

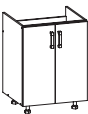

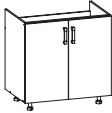

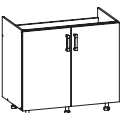

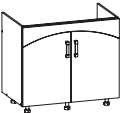



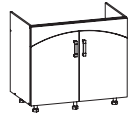

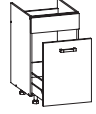

DNW-90/82-L/L		packages	carcass dimensions	carcass colours	available in	comments
		<u>carcass</u> DNW-90/82	<u>width</u> 848 mm	BI KLN	<i>Royal</i>	[11] [22] [25] [14] [15] [16]
	<u>doors</u> 713/321-N* (-LN*)	<u>depth</u> 848 mm	<u>depth of side</u> 508 mm	BE OLS	CAPITAL	[34] [35] [36]
		<u>height</u> 820 mm	<u>cabinet fills</u> corner 90 / 90 cm	BU WE	<i>Sentima</i>	[3]P [4] [7] [9] [12]P
				DMI WIEL	TRAFFIC	[4-] [5-] [6-] [7-]
				DW WISE	<i>Classic</i>	<i>Dekorado Ledo Melos Rosa</i>
				KA WISP	Modern	Diona Hedar Telesto
				KAS SZ	BRW	<i>FAL KAR POR EKR TAF_MDF</i>
						* depending on kitchen doors may have different measurements: 713/312-LN - [22] <i>Melos</i> 713/313-N - [25] 713/317-N (-LN) - [11] [14] [15] [16] [34] [35] [36] Telesto 713/318-N - [5-] [7-] Diona Hedar 713/319-N - [4-] [6-] 713/320-N (-LN) - <i>Rosa, Ledo</i> 713/321-N (-LN) - [4] [7] [12]P 713/325-N - [9] [3]P <i>Dekorado</i> * package contains door set for corner cabinet DNW-90/82-L/L
DNW-90/82-P/P		packages	carcass dimensions	carcass colours	available in	comments
		<u>carcass</u> DNW-90/82	<u>width</u> 848 mm	BI KLN	<i>Royal</i>	[11] [22] [25] [14] [15] [16]
	<u>doors</u> 713/321-N* (-PN*)	<u>depth</u> 848 mm	<u>depth of side</u> 508 mm	BE OLS	CAPITAL	[34] [35] [36]
		<u>height</u> 820 mm	<u>cabinet fills</u> corner 90 / 90 cm	BU WE	<i>Sentima</i>	[3]P [4] [7] [9] [12]P
				DMI WIEL	TRAFFIC	[4-] [5-] [6-] [7-]
				DW WISE	<i>Classic</i>	<i>Dekorado Ledo Melos Rosa</i>
				KA WISP	Modern	Diona Hedar Telesto
				KAS SZ	BRW	<i>FAL KAR POR EKR TAF_MDF</i>
						* depending on kitchen doors may have different measurements: 713/312-PN - [22] <i>Melos</i> 713/313-N - [25] 713/317-N (-PN) - [11] [14] [15] [16] [34] [35] [36] Telesto 713/318-N - [5-] [7-] Diona Hedar 713/319-N - [4-] [6-] 713/320-N (-PN) - <i>Rosa, Ledo</i> 713/321-N (-PN) - [4] [7] [12]P 713/325-N - [9] [3]P <i>Dekorado</i> * package contains door set for corner cabinet DNW-90/82-L/L
DNW-105/82-L		packages	carcass dimensions	carcass colours	available in	comments
		<u>carcass</u> DNW-105/82	<u>width</u> 900 mm	BI KLN	<i>Royal</i>	[11] [22] [25] [14] [15] [16]
	<u>door</u> 713/446 (-L)	<u>depth</u> 600 mm	<u>depth of side</u> 560 mm	BE OLS	CAPITAL	[34] [35] [36]
		<u>height</u> 820 mm	<u>cabinet fills</u> corner 105 / 60 cm	BU WE	<i>Sentima</i>	[3]P [4] [7] [9] [12]P
				DMI WIEL	TRAFFIC	[4-] [5-] [6-] [7-]
				DW WISE	<i>Classic</i>	<i>Dekorado Ledo Melos Rosa</i>
				KA WISP	Modern	Diona Hedar Telesto
				KAS SZ	BRW	<i>FAL KAR POR EKR TAF_MDF</i>
DNW-105/82-P		packages	carcass dimensions	carcass colours	available in	comments
		<u>carcass</u> DNW-105/82	<u>width</u> 900 mm	BI KLN	<i>Royal</i>	[11] [22] [25] [14] [15] [16]
	<u>door</u> 713/446 (-P)	<u>depth</u> 600 mm	<u>depth of side</u> 560 mm	BE OLS	CAPITAL	[34] [35] [36]
		<u>height</u> 820 mm	<u>cabinet fills</u> corner 105 / 60 cm	BU WE	<i>Sentima</i>	[3]P [4] [7] [9] [12]P
				DMI WIEL	TRAFFIC	[4-] [5-] [6-] [7-]
				DW WISE	<i>Classic</i>	<i>Dekorado Ledo Melos Rosa</i>
				KA WISP	Modern	Diona Hedar Telesto
				KAS SZ	BRW	<i>FAL KAR POR EKR TAF_MDF</i>
DNWU-90/82-L		packages	carcass dimensions	carcass colours	available in	comments
		<u>carcass</u> DNWU-90/82	<u>width</u> 860 mm	BI KLN	<i>Royal</i>	[11] [22] [25] [14] [15] [16]
	<u>door</u> 713/456 (-L)	<u>depth</u> 860 mm	<u>depth of side</u> 522 mm	BE OLS	CAPITAL	[34] [35] [36]
		<u>height</u> 820 mm	<u>cabinet fills</u> corner 90 / 90 cm	BU WE	<i>Sentima</i>	[3]P [4] [7] [9] [12]P
				DMI WIEL	TRAFFIC	[4-] [5-] [6-] [7-]
				DW WISE	<i>Classic</i>	<i>Dekorado Ledo Melos Rosa</i>
				KA WISP	Modern	Diona Hedar Telesto
				KAS SZ	BRW	<i>FAL KAR POR EKR TAF_MDF</i>
DNWU-90/82-P		packages	carcass dimensions	carcass colours	available in	comments
		<u>carcass</u> DNWU-90/82	<u>width</u> 860 mm	BI KLN	<i>Royal</i>	[11] [22] [25] [14] [15] [16]
	<u>door</u> 713/456 (-P)	<u>depth</u> 860 mm	<u>depth of side</u> 522 mm	BE OLS	CAPITAL	[34] [35] [36]
		<u>height</u> 820 mm	<u>cabinet fills</u> corner 90 / 90 cm	BU WE	<i>Sentima</i>	[3]P [4] [7] [9] [12]P
				DMI WIEL	TRAFFIC	[4-] [5-] [6-] [7-]
				DW WISE	<i>Classic</i>	<i>Dekorado Ledo Melos Rosa</i>
				KA WISP	Modern	Diona Hedar Telesto
				KAS SZ	BRW	<i>FAL KAR POR EKR TAF_MDF</i>
DNWUST/4-90/82-2S		packages	carcass dimensions	carcass colours	available in	comments
		<u>carcass</u> DNWUST/4-90/82	<u>width</u> 450 mm	KA	<i>Royal</i>	[11] [22] [25]
		<u>doors</u> 355/446-ST x2	<u>depth</u> 865 mm	KAS		
	<u>drawers</u> DS-45-WU-KOR x2	<u>depth of side</u> 658 mm	<u>height</u> 820 mm			
		<u>cabinet fills</u> corner 90 / 90* cm				
						TANDEMBOX ® drawers with guides and BLUMOTION ® <i>blum</i> shock absorber system * to properly build cabinet DNWUST/4 in corner 90 / 90 cm apply blender DBN45-4/82



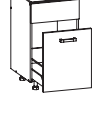

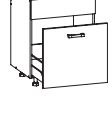
DNWUST/4-90/82-S/2S		packages	carcass dimensions	carcass colours	available in	comments
4 		carcass	DNWUST/4-90/82	width 450 mm	KA	<i>Royal</i> [11] [22] [25]
		doors	355/446-ST 176/446-ST x2	depth 865 mm depth of side 658 mm	KAS	
		drawers	DS-45-WU-KOR DS-45-NU-KOR x2	height 820 mm		
				cabinet fills corner 90 / 90° cm		TANDEMBOX® drawers with guides and BLUMOTION® blum shock absorber system * to properly build cabinet DNWUST/4 in corner 90 / 90 cm apply blender DBNW45-4/82
DNWUST/5-90/82-2S/5		packages	carcass dimensions	carcass colours	available in	comments
5 		carcass	DNWUST/5-90/82	width 450 mm	DMI	<i>Classic</i> <i>Rosa Melos</i> Modern Diona Hedar Telesto
		doors	284/446-ST x2 140/446-ST	depth 865 mm depth of side 658 mm	KLN WE	
		drawers	DS-45-WU-KOR x2 DS-45-NU-KOR	height 820 mm	WIEL WISE	
				cabinet fills corner 90 / 90° cm		* to properly build cabinet DNWUST/5 in corner 90 / 90 cm apply blender DBNW45-4/82
DNWUST/5-90/82-S/3S		packages	carcass dimensions	carcass colours	available in	comments
5 		carcass	DNWUST/5-90/82	width 450 mm	DMI	<i>Classic</i> <i>Rosa Melos</i> Modern Diona Hedar Telesto
		doors	284/446-ST 140/446-ST x3	depth 865 mm depth of side 658 mm	KLN WE	
		drawers	DS-45-WU-KOR DS-45-NU-KOR x3	height 820 mm	WIEL WISE	
				cabinet fills corner 90 / 90° cm		* to properly build cabinet DNWUST/5 in corner 90 / 90 cm apply blender DBNW45-4/82
DNWL-105/136-L/B		packages	carcass dimensions	carcass colours	available in	comments
5 		carcass	DNWL-105/136	width 900 mm	BU	<i>Royal</i> [14] [15] [16] CAPITAL [34] [35] [36] <i>Sentima</i> [3]P [4] [7] [9] [12]P TRAFFIC [4-] [5-] [6-] [7-]
		doors	1261/446 (-L) 500/596-B	depth 600 mm depth of side 560 mm	DW OLS	
				height 1364 mm	WIEL WISE WISP	
				cabinet fills corner 105 / 60 cm		
DNWP-105/136-P/B		packages	carcass dimensions	carcass colours	available in	comments
5 		carcass	DNWP-105/136	width 900 mm	BU	<i>Royal</i> [14] [15] [16] CAPITAL [34] [35] [36] <i>Sentima</i> [3]P [4] [7] [9] [12]P TRAFFIC [4-] [5-] [6-] [7-]
		doors	1261/446 (-P) 500/596-B	depth 600 mm depth of side 560 mm	DW OLS	
				height 1364 mm	WIEL WISE WISP	
				cabinet fills corner 105 / 60 cm		
DNWL-105/143-L/B		packages	carcass dimensions	carcass colours	available in	comments
4 		carcass	DNWL-105/143	width 900 mm	KA	<i>Royal</i> [11] [22] [25]
		doors	1327/446 (-L) 566/596-B	depth 600 mm depth of side 560 mm	KAS	
				height 1430 mm		
				cabinet fills corner 105 / 60 cm		
DNWP-105/143-P/B		packages	carcass dimensions	carcass colours	available in	comments
4 		carcass	DNWP-105/143	width 900 mm	KA	<i>Royal</i> [11] [22] [25]
		doors	1327/446 (-P) 566/596-B	depth 600 mm depth of side 560 mm	KAS	
				height 1430 mm		
				cabinet fills corner 105 / 60 cm		
DNZ-30/82		packages	carcass dimensions	carcass colours	available in	comments
1 		carcass	DNZ-30/82	width 300 mm	BI OLS	<i>Royal</i> [11] CAPITAL [34] [35] [36] <i>Sentima</i> [3] [3]P [4] [7] [9] [12]P TRAFFIC [4-] [5-] [6-] [7-] <i>Classic</i> <i>Dekorado Ledo Melos Rosa</i> Modern Diona Hedar Telesto BRW <i>FAL KAR POR EKR TAF_MDF</i>
				depth 560 mm	BE WE	
				height 820 mm	BU WIEL DMI WISE DW WISP KAS SZ KLN	cabinet may finish assembly from left or right side

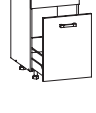

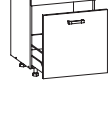

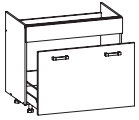



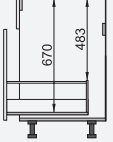



DNZUF-30/82-L/L		packages	carcass dimensions	carcass colours	available in	comments
		carcass DNZUF-30/82	width 300 mm	BI OLS	Sentima TRAFFIC Classic Modern BRW	[3]P [4] [7] [9] [12]P [4-] [5-] [6-] [7-] Dekorado Ledo Melos Rosa Diona Hedar Telesto FAL KAR POR EKR TAF_MDF
		doors 713/296-Z* (-LZ*)	depth 547** mm height 820 mm	BE WIEL BU WISE DMI SZ DW KLN WE		
* package contains door set for corner cabinet DNZUF-30/82-L/L						
** cabinet carcass DNZUF-30/82-L/L should be drawn back by 13 mm regarding neighbouring cabinets						
DNZUF-30/82-P/P		packages	carcass dimensions	carcass colours	available in	comments
		carcass DNZUF-30/82	width 300 mm	BI OLS	Sentima TRAFFIC Classic Modern BRW	[3]P [4] [7] [9] [12]P [4-] [5-] [6-] [7-] Dekorado Ledo Melos Rosa Diona Hedar Telesto FAL KAR POR EKR TAF_MDF
		doors 713/296-Z* (-LP*)	depth 547** mm height 820 mm	BE WIEL BU WISE DMI SZ DW KLN WE		
* package contains door set for corner cabinet DNZUF-30/82-P/P						
** cabinet carcass DNZUF-30/82-P/P should be drawn back by 13 mm regarding neighbouring cabinets						
DNZU2F-30/82-L/LU		packages	carcass dimensions	carcass colours	available in	comments
		carcass DNZU2F-30/82	width 300 mm	KAS	Royal CAPITAL	[11] [34] [35]
		doors 713/296_446-U*	depth 560 mm height 820 mm	WISE WISP		
* package contains door set for corner cabinet DNZU2F-30/82-L/LU						
DNZU2F-30/82-P/PU		packages	carcass dimensions	carcass colours	available in	comments
		carcass DNZU2F-30/82	width 300 mm	KAS	Royal CAPITAL	[11] [34] [35]
		doors 713/296_446-U*	depth 560 mm height 820 mm	WISE WISP		
* package contains door set for corner cabinet DNZU2F-30/82-P/PU						
DNZR-30/82		packages	carcass dimensions	carcass colours	available in	comments
		carcass DNZR-30/82	width 300 mm	DW	Royal	[22] [25] [14] [15] [16]
			depth 560 mm height 820 mm	KA KAS OLS WISP		
cabinet may finish assembly from left or right side						
DNZRF-30/82-L/LR		packages	carcass dimensions	carcass colours	available in	comments
		carcass DNZRF-30/82	width 300 mm	DW	Royal	[22] [25] [14] [15] [16]
		doors 713/260 (-L) 713/300 (-LR)	depth 560 mm height 820 mm	KA KAS OLS WISP		
DNZRF-30/82-P/PR		packages	carcass dimensions	carcass colours	available in	comments
		carcass DNZRF-30/82	width 300 mm	DW	Royal	[22] [25] [14] [15] [16]
		doors 713/260 (-P) 713/300 (-PR)	depth 560 mm height 820 mm	KA KAS OLS WISP		
DNZL30/82		packages	carcass dimensions	carcass colours	to be done in the kitchen	comments
		carcass DNZL30/82*	width 300 mm	BUS	Royal CAPITAL Sentima TRAFFIC Classic Modern BRW	[11] [22] [25] [14] [15] [16] [34] [35] [36] [3]P [4] [7] [9] [12]P [4-] [5-] [6-] [7-] Dekorado Ledo Melos Rosa Diona Hedar Telesto FAL KAR POR EKR TAF_MDF
			depth 560 mm height 820 mm	CE GRR MI OLS PI PB		
* carcass made to order as from panels # 28 or # 38 mm; visible edges have melamine glued on						











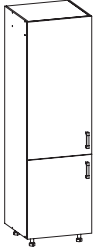

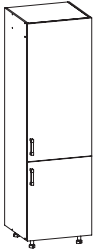
DNZP-30/82		packages	carcass dimensions		carcass colours		to be done in the kitchen			comments
		carcass DNZP-30/82*	width	300 mm	BUS	<i>Royal</i>	[11] [22] [25] [14] [15] [16]	* carcass made to order as non-typical from panels # 28 or # 38 mm; visible edges have melamine glued on		
			depth	560 mm	CE	CAPITAL	[34] [35] [36]			
			height	820 mm	GRR	<i>Sentima</i>	[3]P [4] [7] [9] [12]P			
					MI	TRAFFIC	[4-] [5-] [6-] [7-]			
				OLS	<i>Classic</i>	<i>Dekorado Ledo Melos Rosa</i>				
				PI	Modern	Diona Hedar Telesto				
				PB	BRW	FAL KAR POR EKR TAF_MDF				
DNZRL-30/82		packages	carcass dimensions		carcass colours		to be done in the kitchen			comments
		carcass DNZRL-30/82*	width	300 mm	BUS	<i>Royal</i>	[11] [22] [25] [14] [15] [16]	* carcass made to order as non-typical from panels # 28 or # 38 mm; visible edges have melamine glued on		
			depth	560 mm	CE	CAPITAL	[34] [35] [36]			
			height	820 mm	GRR	<i>Sentima</i>	[3]P [4] [7] [9] [12]P			
					MI	TRAFFIC	[4-] [5-] [6-] [7-]			
				OLS	<i>Classic</i>	<i>Dekorado Ledo Melos Rosa</i>				
				PI	Modern	Diona Hedar Telesto				
				PB	BRW	FAL KAR POR EKR TAF_MDF				
DNZRP-30/82		packages	carcass dimensions		carcass colours		to be done in the kitchen			comments
		carcass DNZRP-30/82*	width	300 mm	BUS	<i>Royal</i>	[11] [22] [25] [14] [15] [16]	* carcass made to order as non-typical from panels # 28 or # 38 mm; visible edges have melamine glued on		
			depth	560 mm	CE	CAPITAL	[34] [35] [36]			
			height	820 mm	GRR	<i>Sentima</i>	[3]P [4] [7] [9] [12]P			
					MI	TRAFFIC	[4-] [5-] [6-] [7-]			
				OLS	<i>Classic</i>	<i>Dekorado Ledo Melos Rosa</i>				
				PI	Modern	Diona Hedar Telesto				
				PB	BRW	FAL KAR POR EKR TAF_MDF				

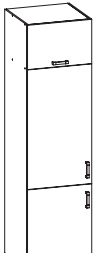

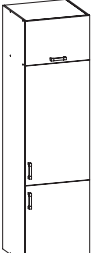

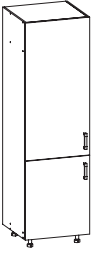

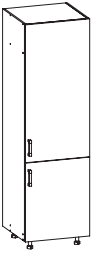





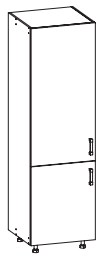



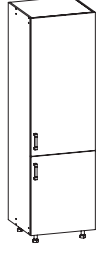



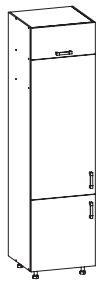

DK-45/82-L		packages	carcass dimensions	carcass colours	available in	comments
		carcass DK-45/82	width 450 mm	BI KLN	Royal	[11] [22] [25] [14] [15] [16]
		door 713/446 (-L)	depth 508 mm	BE OLS	CAPITAL	[34] [35] [36]
			height 820 mm	BU WE	Sentima	[3]P [4] [7] [9] [12]P
				DMI WIEL	TRAFFIC	[4-] [5-] [6-] [7-]
				DW WISE	Classic	Dekorado Ledo Melos Rosa
				KA WISP	Modern	Diona Hedar Telesto
				KAS SZ	BRW	FAL KAR POR EKR TAF_MDF
DK-45/82-P		packages	carcass dimensions	carcass colours	available in	comments
		carcass DK-45/82	width 450 mm	BI KLN	Royal	[11] [22] [25] [14] [15] [16]
		door 713/446 (-P)	depth 508 mm	BE OLS	CAPITAL	[34] [35] [36]
			height 820 mm	BU WE	Sentima	[3]P [4] [7] [9] [12]P
				DMI WIEL	TRAFFIC	[4-] [5-] [6-] [7-]
				DW WISE	Classic	Dekorado Ledo Melos Rosa
				KA WISP	Modern	Diona Hedar Telesto
				KAS SZ	BRW	FAL KAR POR EKR TAF_MDF
DK-60/82-L		packages	carcass dimensions	carcass colours	available in	comments
		carcass DK-60/82	width 600 mm	BI KLN	Royal	[11] [22] [25] [14] [15] [16]
		door 713/596 (-L)	depth 508 mm	BE OLS	CAPITAL	[34] [35] [36]
			height 820 mm	BU WE	Sentima	[3]P [4] [7] [9] [12]P
				DMI WIEL	TRAFFIC	[4-] [5-] [6-] [7-]
				DW WISE	Classic	Dekorado Ledo Melos Rosa
				KA WISP	Modern	Diona Hedar Telesto
				KAS SZ	BRW	FAL KAR POR EKR TAF_MDF
DK-60/82-P		packages	carcass dimensions	carcass colours	available in	comments
		carcass DK-60/82	width 600 mm	BI KLN	Royal	[11] [22] [25] [14] [15] [16]
		door 713/596 (-P)	depth 508 mm	BE OLS	CAPITAL	[34] [35] [36]
			height 820 mm	BU WE	Sentima	[3]P [4] [7] [9] [12]P
				DMI WIEL	TRAFFIC	[4-] [5-] [6-] [7-]
				DW WISE	Classic	Dekorado Ledo Melos Rosa
				KA WISP	Modern	Diona Hedar Telesto
				KAS SZ	BRW	FAL KAR POR EKR TAF_MDF
DK-60/82-L/P		packages	carcass dimensions	carcass colours	available in	comments
		carcass DK-60/82	width 600 mm	BI KLN	Royal	[11] [22] [25] [14] [15] [16]
		doors 713/296 (-L) 713/296 (-P)	depth 508 mm	BE OLS	CAPITAL	[34] [35] [36]
			height 820 mm	BU WE	Sentima	[3]P [4] [7] [9] [12]P
				DMI WIEL	TRAFFIC	[4-] [5-] [6-] [7-]
				DW WISE	Classic	Dekorado Ledo Melos Rosa
				KA WISP	Modern	Diona Hedar Telesto
				KAS SZ	BRW	FAL KAR POR EKR TAF_MDF
DK-80/82-L/P		packages	carcass dimensions	carcass colours	available in	comments
		carcass DK-80/82	width 800 mm	BI WE	Sentima	[3]P [4] [7] [9] [12]P
		doors 713/396 (-L) 713/396 (-P)	depth 508 mm	BE WIEL	TRAFFIC	[4-] [5-] [6-] [7-]
			height 820 mm	BU WISE	Classic	Dekorado Ledo Melos Rosa
				DMI WISP	Modern	Diona Hedar Telesto
				DW SZ	BRW	FAL KAR POR EKR TAF_MDF
				KLN		
				OLS		
DK-90/82-L/P		packages	carcass dimensions	carcass colours	available in	comments
		carcass DK-90/82	width 900 mm	BU WISE	Royal	[11] [22] [25] [14] [15] [16]
		doors 713/446 (-L) 713/446 (-P)	depth 508 mm	DW WISP	CAPITAL	[34] [35] [36]
			height 820 mm	KA	Sentima	[3]P [4] [7] [9] [12]P
				KAS	TRAFFIC	[4-] [5-] [6-] [7-]
				OLS		
				WIEL		
DBK/4-90/82-L/P/B		packages	carcass dimensions	carcass colours	available in	comments
		carcass DBK/4-90/82	width 900 mm	KA	Royal	[22]
		doors 633/446-LE 633/446-PE 176/896-E	depth 508 mm			
			height 820 mm			

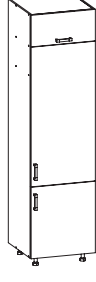



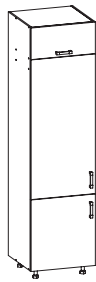



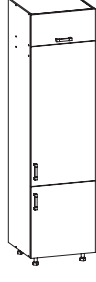







		packages	carcass dimensions	carcass colours	available in	comments
		carcass DBK/5-90/82	width 900 mm	BU	<i>Royal</i> [14] [15]	* depending on kitchen doors may have different measurements: 615/446-LE (-PE) - [7] 620/446-LE (-PE) - [4] [12]P 621/446-LDE (-PDE) - [14] 645/446-LDE (-PDE) - [15]
		doors 620/446-LE* (-LDE*) 620/446-PE* (-PDE*) 140/896-E	depth 508 mm height 820 mm	DW OLS WIEL WISP	<i>Sentima</i> [4] [7] [12]P	
		carcass DKSM/5-45/82	width 450 mm	BI OLS	<i>Sentima</i> [3] [3]P [4] [7] [9] [12]P	drawer on METABOX® blum rails
		doors 570/446-SM 140/446-B	depth 508 mm height 820 mm	BE WIEL BU WISE DMI SZ DW KLN WE	<i>TRAFFIC</i> [4-] [5-] [6-] [7-] <i>Classic</i> <i>Dekorado Ledo Melos Rosa</i> <i>Modern</i> Diona Hedar Telesto <i>BRW</i> <i>FAL KAR POR EKR TAF_MDF</i>	
		carcass DKSM/5-60/82	width 600 mm	BI OLS	[3] [3]P [4] [7] [9] [12]P	drawer on METABOX® blum rails
		doors 570/596-SM 140/596-B	depth 508 mm height 820 mm	BE WIEL BU WISE DMI SZ DW KLN WE	<i>TRAFFIC</i> [4-] [5-] [6-] [7-] <i>Classic</i> <i>Dekorado Ledo Melos Rosa</i> <i>Modern</i> Diona Hedar Telesto <i>BRW</i> <i>FAL KAR POR EKR TAF_MDF</i>	
		carcass DKSM/5-90/82	width 900 mm	BI OLS	<i>Classic</i> <i>Dekorado Ledo Melos Rosa</i>	drawer on METABOX® blum rails
		doors 570/896-SM 140/896-B	depth 508 mm height 820 mm	BE WIEL BU WISE DMI SZ DW KLN WE	<i>Modern</i> Diona Hedar Telesto <i>BRW</i> <i>FAL KAR POR EKR TAF_MDF</i>	
		carcass DKST/5-45/82	width 450 mm	KA	<i>Royal</i> [11] [22] [25]	TANDEMBOX® drawers with guides and BLUMOTION® blum shock absorber system
		doors 534/446-ST 176/446-B	depth 508 mm height 820 mm	KAS		
		carcass DKST/5-60/82	width 600 mm	KA	<i>Royal</i> [11] [22] [25]	TANDEMBOX® drawers with guides and BLUMOTION® blum shock absorber system
		doors 534/596-ST 176/596-B	depth 508 mm height 820 mm	KAS		
		carcass DKST/5-45/82	width 450 mm	BI WIEL	<i>Royal</i> [14] [15] [16]	TANDEMBOX® drawers with guides and BLUMOTION® blum shock absorber system
		doors 570/446-ST 140/446-B	depth 508 mm height 820 mm	BE WISE DMI WISP DW SZ KLN WE OLS	<i>CAPITAL</i> [34] [35] [36] <i>Classic</i> <i>Dekorado Ledo Melos Rosa</i> <i>Modern</i> Diona Hedar Telesto <i>BRW</i> <i>FAL KAR POR EKR TAF_MDF</i>	
		carcass DKST/5-60/82	width 600 mm	BI WIEL	[14] [15] [16]	TANDEMBOX® drawers with guides and BLUMOTION® blum shock absorber system
		doors 570/596-ST 140/596-B	depth 508 mm height 820 mm	BE WISE DMI WISP DW SZ KLN WE OLS	<i>CAPITAL</i> [34] [35] [36] <i>Classic</i> <i>Dekorado Ledo Melos Rosa</i> <i>Modern</i> Diona Hedar Telesto <i>BRW</i> <i>FAL KAR POR EKR TAF_MDF</i>	

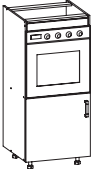





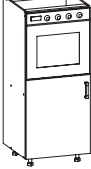

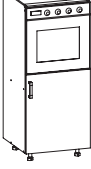

DKST/5-90/82-S/B		packages	carcass dimensions		carcass colours		available in	comments
<div style="display: flex; align-items: center;"> <div style="border: 1px solid black; padding: 2px; margin-right: 5px;">5</div>  </div>	carcass	DKST/5-90/82	width	900 mm	BI	WIEL	 <i>Dekorado Ledo Melos Rosa</i>  <i>Diona Hedar Telesto</i>  <i>FAL KAR POR EKR TAF_MDF</i>	<p>TANDEMBOX® drawers with guides and BLUMOTION® blum shock absorber system</p> 
	doors	570/896-ST 140/896-B	depth	508 mm	BE	WISE		
	drawer	DS-90-W-KOR	height	820 mm	DMI	WISP		
					DW	SZ		
					KLN			
					WE			
					OLS			

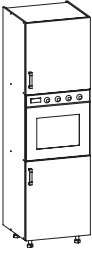

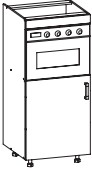



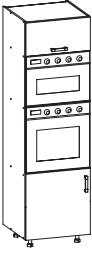

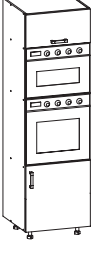





DM-45/57		packages	carcass dimensions		carcass colours	available in	comments
	carcass	—	width	—	—	<i>Royal</i> CAPITAL <i>Sentima</i> TRAFFIC <i>Classic</i> Modern BRW LINE	[11] [22] [25] [14] [15] [16] [34] [35] [36] [3]P [4] [7] [9] [12]P [4-] [5-] [6-] [7-] Dekorado Ledo Melos Rosa Diona Hedar Telesto FAL KAR POR EKR TAF_MDF
	door	570/446-M	depth	—			
		height	—				
DM-45/71		packages	carcass dimensions		carcass colours	available in	comments
	carcass	—	width	—	—	<i>Royal</i> CAPITAL <i>Sentima</i> TRAFFIC <i>Classic</i> Modern BRW LINE	[11] [22] [25] [14] [15] [16] [34] [35] [36] [3]P [4] [7] [9] [12]P [4-] [5-] [6-] [7-] Dekorado Ledo Melos Rosa Diona Hedar Telesto FAL KAR POR EKR TAF_MDF
	door	713/446-M	depth	—			
		height	—				
DM-60/57		packages	carcass dimensions		carcass colours	available in	comments
	carcass	—	width	—	—	<i>Royal</i> CAPITAL <i>Sentima</i> TRAFFIC <i>Classic</i> Modern BRW LINE	[11] [22] [25] [14] [15] [16] [34] [35] [36] [3]P [4] [7] [9] [12]P [4-] [5-] [6-] [7-] Dekorado Ledo Melos Rosa Diona Hedar Telesto FAL KAR POR EKR TAF_MDF
	door	570/446-M	depth	—			
		height	—				
DM-60/71		packages	carcass dimensions		carcass colours	available in	comments
	carcass	—	width	—	—	<i>Royal</i> CAPITAL <i>Sentima</i> TRAFFIC <i>Classic</i> Modern BRW LINE	[11] [22] [25] [14] [15] [16] [34] [35] [36] [3]P [4] [7] [9] [12]P [4-] [5-] [6-] [7-] Dekorado Ledo Melos Rosa Diona Hedar Telesto FAL KAR POR EKR TAF_MDF
	door	713/596-M	depth	—			
		height	—				
DL-60/136-L		packages	carcass dimensions		carcass colours	available in	comments
	carcass	DL-60/136	width	600 mm	BU	<i>Royal</i> CAPITAL <i>Sentima</i> TRAFFIC	[14] [15] [16] [34] [35] [36] [3]P [4] [7] [9] [12]P [4-] [5-] [6-] [7-]
	door	1261/596 (-L)	depth	560 mm	DW		
		height	1364 mm	OLS WIEL WISE WISP			
 x4	cabinet for refrigerator housing, internal dimensions shown in catalogue System in a Nutshell on p. 57						
DL-60/136-P		packages	carcass dimensions		carcass colours	available in	comments
	carcass	DL-60/136	width	600 mm	BU	<i>Royal</i> CAPITAL <i>Sentima</i> TRAFFIC	[14] [15] [16] [34] [35] [36] [3]P [4] [7] [9] [12]P [4-] [5-] [6-] [7-]
	door	1261/596 (-P)	depth	560 mm	DW		
		height	1364 mm	OLS WIEL WISE WISP			
 x4	cabinet for refrigerator housing, internal dimensions shown in catalogue System in a Nutshell on p. 57						
DL-60/143-L		packages	carcass dimensions		carcass colours	available in	comments
	carcass	DL-60/143	width	600 mm	KA	<i>Royal</i>	[11] [22] [25]
	door	1327/596 (-L)	depth	560 mm	KAS		
		height	1430 mm				
 x4	cabinet for refrigerator housing, internal dimensions shown in catalogue System in a Nutshell on p. 57						
DL-60/143-P		packages	carcass dimensions		carcass colours	available in	comments
	carcass	DL-60/143	width	600 mm	KA	<i>Royal</i>	[11] [22] [25]
	door	1327/596 (-P)	depth	560 mm	KAS		
		height	1430 mm				
 x4	cabinet for refrigerator housing, internal dimensions shown in catalogue System in a Nutshell on p. 57						





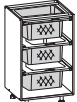

DL-60/207-L/L		packages	carcass dimensions		carcass colours		available in	comments	
	carcass	DL-60/207	width	600 mm	BI	KLN	<i>Royal</i> CAPITAL <i>Sentima</i> TRAFFIC <i>Classic</i> Modern 	[11] [22] [25] [14] [15] [16] [34] [35] [36] [3]P [4] [7] [9] [12]P [4-] [5-] [6-] [7-] Dekorado Ledo Melos Rosa Diona Hedar Telesto FAL KAR POR EKR TAF_MDF	cabinet for refrigerator housing, internal dimensions shown in catalogue System in a Nutshell on p. 57
	doors	713/596 (-L) 1247/596 (-L)	depth	560 mm	BE	OLS			
			height	2066 mm	BU	WE			
					DMI	WIEL			
					DW	WISE			
					KA	WISP			
					KAS	SZ			
									
DL-60/207-P/P		packages	carcass dimensions		carcass colours		available in	comments	
	carcass	DL-60/207	width	600 mm	BI	KLN	<i>Royal</i> CAPITAL <i>Sentima</i> TRAFFIC <i>Classic</i> Modern 	[11] [22] [25] [14] [15] [16] [34] [35] [36] [3]P [4] [7] [9] [12]P [4-] [5-] [6-] [7-] Dekorado Ledo Melos Rosa Diona Hedar Telesto FAL KAR POR EKR TAF_MDF	cabinet for refrigerator housing, internal dimensions shown in catalogue System in a Nutshell on p. 57
	doors	713/596 (-P) 1247/596 (-P)	depth	560 mm	BE	OLS			
			height	2066 mm	BU	WE			
					DMI	WIEL			
					DW	WISE			
					KA	WISP			
					KAS	SZ			
									
DLO-60/230-L/L/O		packages	carcass dimensions		carcass colours		available in	comments	
	carcass	DLO-60/230	width	600 mm	BI	KLN	<i>Royal</i> CAPITAL <i>Sentima</i> TRAFFIC <i>Classic</i> Modern 	[11] [22] [25] [14] [15] [16] [34] [35] [36] [3]P [4] [7] [9] [12]P [4-] [5-] [6-] [7-] Dekorado Ledo Melos Rosa Diona Hedar Telesto FAL KAR POR EKR TAF_MDF	cabinet for refrigerator housing, internal dimensions shown in catalogue System in a Nutshell on p. 57
	doors	713/596 (-L) 1081/596 (-L) 393/596-O	depth	560 mm	BE	OLS			
			height	2296 mm	BU	WE			
					DMI	WIEL			
					DW	WISE			
					KA	WISP			
					KAS	SZ			
									
DLO-60/230-P/P/O		packages	carcass dimensions		carcass colours		available in	comments	
	carcass	DLO-60/230	width	600 mm	BI	KLN	<i>Royal</i> CAPITAL <i>Sentima</i> TRAFFIC <i>Classic</i> Modern 	[11] [22] [25] [14] [15] [16] [34] [35] [36] [3]P [4] [7] [9] [12]P [4-] [5-] [6-] [7-] Dekorado Ledo Melos Rosa Diona Hedar Telesto FAL KAR POR EKR TAF_MDF	cabinet for refrigerator housing, internal dimensions shown in catalogue System in a Nutshell on p. 57
	doors	713/596 (-P) 1081/596 (-P) 393/596-O	depth	560 mm	BE	OLS			
			height	2296 mm	BU	WE			
					DMI	WIEL			
					DW	WISE			
					KA	WISP			
					KAS	SZ			
									
DL/NT160-60/207-L/L		packages	carcass dimensions		carcass colours		available in	comments	
	carcass	DL/NT160-60/207*	width	600 mm	BI	KLN	<i>Royal</i> CAPITAL <i>Sentima</i> TRAFFIC <i>Classic</i> Modern 	[11] [22] [25] [14] [15] [16] [34] [35] [36] [3]P [4] [7] [9] [12]P [4-] [5-] [6-] [7-] Dekorado Ledo Melos Rosa Diona Hedar Telesto FAL KAR POR EKR TAF_MDF	cabinet for refrigerator housing, internal dimensions shown in catalogue System in a Nutshell on p. 57 * carcass made to order as non-typical
	doors	713/596-NT (-LNT) 1247/596 (-L)	depth	560 mm	BE	OLS			
			height	2066 mm	BU	WE			
					DMI	WIEL			
					DW	WISE			
					KA	WISP			
					KAS	SZ			
									
DL/NT160-60/207-P/P		packages	carcass dimensions		carcass colours		available in	comments	
	carcass	DL/NT160-60/207*	width	600 mm	BI	KLN	<i>Royal</i> CAPITAL <i>Sentima</i> TRAFFIC <i>Classic</i> Modern 	[11] [22] [25] [14] [15] [16] [34] [35] [36] [3]P [4] [7] [9] [12]P [4-] [5-] [6-] [7-] Dekorado Ledo Melos Rosa Diona Hedar Telesto FAL KAR POR EKR TAF_MDF	cabinet for refrigerator housing, internal dimensions shown in catalogue System in a Nutshell on p. 57 * carcass made to order as non-typical
	doors	713/596-NT (-PNT) 1247/596 (-P)	depth	560 mm	BE	OLS			
			height	2066 mm	BU	WE			
					DMI	WIEL			
					DW	WISE			
					KA	WISP			
					KAS	SZ			
									













		packages	carcass dimensions	carcass colours	appear in	comments
 		carcass DL/NT180-60/207*	width 600 mm	BI KLN	<i>Royal</i> CAPITAL <i>Sentima</i> TRAFFIC <i>Classic</i> Modern 	[11] [22] [25] [14] [15] [16] [34] [35] [36] [3]P [4] [7] [9] [12]P [4-] [5-] [6-] [7-] Dekorado Ledo Melos Rosa Diona Hedar Telesto FAL KAR POR EKR TAF_MDF
		doors 713/596-NT (-LNT) 1247/596-NT (-LNT)	depth 560 mm height 2066 mm	BE OLS BU WE DMI WIEL DW WISE KA WISP KAS SZ		
 		carcass DL/NT180-60/207*	width 600 mm	BI KLN	<i>Royal</i> CAPITAL <i>Sentima</i> TRAFFIC <i>Classic</i> Modern 	[11] [22] [25] [14] [15] [16] [34] [35] [36] [3]P [4] [7] [9] [12]P [4-] [5-] [6-] [7-] Dekorado Ledo Melos Rosa Diona Hedar Telesto FAL KAR POR EKR TAF_MDF
		doors 713/596-NT (-PNT) 1247/596-NT (-PNT)	depth 560 mm height 2066 mm	BE OLS BU WE DMI WIEL DW WISE KA WISP KAS SZ		
  		carcass DL/NT160-60/230*	width 600 mm	BU OLS	<i>Royal</i> CAPITAL <i>Sentima</i> TRAFFIC	[14] [15] [16] [34] [35] [36] [3]P [4] [7] [9] [12]P [4-] [5-] [6-] [7-]
		doors 643/596 (-L) 1261/596 (-L) 284/596-O	depth 560 mm height 2296 mm	DMI WE DW WIEL KA WISE KAS WISP KLN		
  		carcass DL/NT160-60/230*	width 600 mm	BU OLS	<i>Royal</i> CAPITAL <i>Sentima</i> TRAFFIC	[14] [15] [16] [34] [35] [36] [3]P [4] [7] [9] [12]P [4-] [5-] [6-] [7-]
		doors 643/596 (-P) 1261/596 (-P) 284/596-O	depth 560 mm height 2296 mm	DMI WE DW WIEL KA WISE KAS WISP KLN		
  		carcass DL/NT180-60/230*	width 600 mm	BU OLS	<i>Royal</i> CAPITAL <i>Sentima</i> TRAFFIC	[14] [15] [16] [34] [35] [36] [3]P [4] [7] [9] [12]P [4-] [5-] [6-] [7-]
		doors 643/596 (-L) 1261/596-NT (-LNT) 284/596-O	depth 560 mm height 2296 mm	DMI WE DW WIEL KA WISE KAS WISP KLN		
  		carcass DL/NT180-60/230*	width 600 mm	BU OLS	<i>Royal</i> CAPITAL <i>Sentima</i> TRAFFIC	[14] [15] [16] [34] [35] [36] [3]P [4] [7] [9] [12]P [4-] [5-] [6-] [7-]
		doors 643/596 (-P) 1261/596-NT (-PNT) 284/596-O	depth 560 mm height 2296 mm	DMI WE DW WIEL KA WISE KAS WISP KLN		









DP-60/82-K		packages	carcass dimensions		carcass colours		available in	comments
		carcass DP-60/82	width 600 mm	BI	KLN	<i>Royal</i> CAPITAL <i>Sentima</i> TRAFFIC <i>Classic</i> Modern BRW	[11] [22] [25] [14] [15] [16]	cabinet housing oven, internal dimensions shown in catalogue System in a Nutshell on p. 57
		door 110/596-K	depth 560 mm	BE	OLS		[34] [35] [36]	
height 820 mm		BU	WE	[3]P [4] [7] [9] [12]P				
		DMI	WIEL	[4-] [5-] [6-] [7-]				
		DW	WISE	<i>Dekorado Ledo Melos Rosa</i>				
		KA	WISP	Diona Hedar Telesto				
		KAS	SZ	<i>FAL KAR POR EKR TAF_MDF</i>				
DPS-60/82-S		packages	carcass dimensions		carcass colours		available in	comments
		carcass DPS-60/82	width 600 mm	DW		<i>Royal</i> CAPITAL	[11] [22] [25] [14] [15] [16]	cabinet housing oven, internal dimensions shown in catalogue System in a Nutshell on p. 57 TANDEMBOX® drawers with guides and BLUMOTION® blum shock absorber system
		door 110/596-S	depth 560 mm	KA			[34] [35] [36]	
		drawer DPS-60-P-KOR	height 820 mm	KAS				
				OLS				
				WISE				
				WISP				
DPSX-60/82-S		packages	carcass dimensions		carcass colours		available in	comments
		carcass DPSX-60/82	width 600 mm	BU		<i>Sentima</i> TRAFFIC	[3]P [4] [7] [9] [12]P	cabinet housing oven, internal dimensions shown in catalogue System in a Nutshell on p. 57 drawer on METABOX® blum rails
		door 110/596-S	depth 560 mm	DW			[4-] [5-] [6-] [7-]	
		drawer SM-320N5000 SM-110/596/500	height 820 mm	OLS				
				WIEL				
				WISE				
DP-60/136-L/B		packages	carcass dimensions		carcass colours		available in	comments
			carcass DP-60/136	width 600 mm	BU	<i>Royal</i> CAPITAL <i>Sentima</i> TRAFFIC	[14] [15] [16]	cabinet housing oven, internal dimensions shown in catalogue System in a Nutshell on p. 57
			doors 570/596 (-L) 87/596-B	depth 560 mm	DW		[34] [35] [36]	
height 1364 mm		OLS	[3]P [4] [7] [9] [12]P					
		WIEL	[4-] [5-] [6-] [7-]					
		WISE						
		WISP						
DP-60/136-P/B		packages	carcass dimensions		carcass colours		available in	comments
			carcass DP-60/136	width 600 mm	BU	<i>Royal</i> CAPITAL <i>Sentima</i> TRAFFIC	[14] [15] [16]	cabinet housing oven, internal dimensions shown in catalogue System in a Nutshell on p. 57
			doors 570/596 (-P) 87/596-B	depth 560 mm	DW		[34] [35] [36]	
height 1364 mm		OLS	[3]P [4] [7] [9] [12]P					
		WIEL	[4-] [5-] [6-] [7-]					
		WISE						
		WISP						
DP-60/143-L		packages	carcass dimensions		carcass colours		available in	comments
			carcass DP-60/143	width 600 mm	KA	<i>Royal</i>	[11] [22] [25]	cabinet housing oven, internal dimensions shown in catalogue System in a Nutshell on p. 57
			door 713/596 (-L)	depth 560 mm	KAS			
			height 1430 mm					
DP-60/143-P		packages	carcass dimensions		carcass colours		available in	comments
			carcass DP-60/143	width 600 mm	KA	<i>Royal</i>	[11] [22] [25]	cabinet housing oven, internal dimensions shown in catalogue System in a Nutshell on p. 57
			door 713/596 (-P)	depth 560 mm	KAS			
			height 1430 mm					





DP-60/207-L/L		packages	carcass dimensions		carcass colours		available in	comments		
		carcass	DP-60/207	width	600 mm	BI KLN	<i>Royal</i>	[11] [22] [25] [14] [15] [16]	cabinet housing oven, internal dimensions shown in catalogue System in a Nutshell on p. 57	
		doors	713/596 (-L) 643/596 (-L)	depth	560 mm	BE OLS BU WE DMI WIEL DW WISE KA WISP KAS SZ	CAPITAL <i>Sentima</i> TRAFFIC <i>Classic</i> Modern BRW	[34] [35] [36] [3]P [4] [7] [9] [12]P [4-] [5-] [6-] [7-] <i>Dekorado Ledo Melos Rosa</i> Diona Hedar Telesto <i>FAL KAR POR EKR TAF_MDF</i>		
DP-60/207-P/P		packages	carcass dimensions		carcass colours		available in	comments		
		carcass	DP-60/207	width	600 mm	BI KLN	<i>Royal</i>	[11] [22] [25] [14] [15] [16]	cabinet housing oven, internal dimensions shown in catalogue System in a Nutshell on p. 57	
		doors	713/596 (-P) 643/596 (-P)	depth	560 mm	BE OLS BU WE DMI WIEL DW WISE KA WISP KAS SZ	CAPITAL <i>Sentima</i> TRAFFIC <i>Classic</i> Modern BRW	[34] [35] [36] [3]P [4] [7] [9] [12]P [4-] [5-] [6-] [7-] <i>Dekorado Ledo Melos Rosa</i> Diona Hedar Telesto <i>FAL KAR POR EKR TAF_MDF</i>		
DP45-60/136-L/B		packages	carcass dimensions		carcass colours		available in	comments		
			carcass	DP45-60/136	width	600 mm	BU	<i>Royal</i>	[14] [15] [16]	cabinet housing kitchen microwave, internal dimensions shown in catalogue System in a Nutshell p. 57
			doors	713/596 (-L) 75/596-B	depth	560 mm	DW OLS WIEL WISE WISP	CAPITAL <i>Sentima</i> TRAFFIC	[34] [35] [36] [3]P [4] [7] [9] [12]P [4-] [5-] [6-] [7-]	
DP45-60/136-P/B		packages	carcass dimensions		carcass colours		available in	comments		
			carcass	DP45-60/136	width	600 mm	BU	<i>Royal</i>	[14] [15] [16]	cabinet housing kitchen microwave, internal dimensions shown in catalogue System in a Nutshell p. 57
			doors	713/596 (-P) 75/596-B	depth	560 mm	DW OLS WIEL WISE WISP	CAPITAL <i>Sentima</i> TRAFFIC	[34] [35] [36] [3]P [4] [7] [9] [12]P [4-] [5-] [6-] [7-]	
DPP450-60/207-L/O		packages	carcass dimensions		carcass colours		available in	comments		
		carcass	DPP450-60/207	width	600 mm	BI WE	<i>Royal</i>	[14] [15] [16]	cabinet for housing oven and kitchen microwave, internal dimensions shown in catalogue System in a Nutshell p. 57	
		doors	570/596 (-L) 316/596-O	depth	560 mm	BE WIEL BU WISE DMI WISP DW SZ KLN OLS	CAPITAL <i>Sentima</i> TRAFFIC Modern BRW	[34] [35] [36] [3]P [4] [7] [9] [12]P [4-] [5-] [6-] [7-] Diona Hedar Telesto <i>EKR TAF_MDF</i>		
DPP450-60/207-P/O		packages	carcass dimensions		carcass colours		available in	comments		
		carcass	DPP450-60/207	width	600 mm	BI WE	<i>Royal</i>	[14] [15] [16]	cabinet for housing oven and kitchen microwave, internal dimensions shown in catalogue System in a Nutshell p. 57	
		doors	570/596 (-P) 316/596-O	depth	560 mm	BE WIEL BU WISE DMI WISP DW SZ KLN OLS	CAPITAL <i>Sentima</i> TRAFFIC Modern BRW	[34] [35] [36] [3]P [4] [7] [9] [12]P [4-] [5-] [6-] [7-] Diona Hedar Telesto <i>EKR TAF_MDF</i>		





DBNW45-4/82		packages	carcass dimensions	carcass colours		available in	comments	
	carcass	DBNW45-4/82	width 40 mm depth 36 mm height 720 mm	BI KLN BE OLS BU WE DMI WIEL DW WISE KA WISP KAS SZ	Royal CAPITAL Sentima TRAFFIC Classic Modern 	[11] [22] [25] [14] [15] [16] [34] [35] [36] [3]P [4] [7] [9] [12]P [4-] [5-] [6-] [7-] Dekorado Ledo Melos Rosa Diona Hedar Telesto FAL KAR POR EKR TAF_MDF	blender DBNW45-4/82 is to build corner 90 / 90 cm with cabinets of type DNWUST or other lower cabinet of height 820 mm and width 450 mm; blender DBNW45-4/82 is sold in sets of 2 items application example shown in catalogue System in a Nutshell p. 62	
	DBNW60-5/82							
		carcass	DBNW60-5/82	width 79 mm depth 36 mm height 720 mm	BI KLN BE OLS BU WE DMI WIEL DW WISE KA WISP KAS SZ	Royal CAPITAL Sentima TRAFFIC Classic Modern 	[11] [22] [25] [14] [15] [16] [34] [35] [36] [3]P [4] [7] [9] [12]P [4-] [5-] [6-] [7-] Dekorado Ledo Melos Rosa Diona Hedar Telesto FAL KAR POR EKR TAF_MDF	blender DBNW60-5/82 is to build corner 105 / 105 cm with lower cabinets of height 820 mm and width 600 mm; blender DBNW60-5/82 is sold in sets of 2 items application example shown in catalogue System in a Nutshell p. 62
		DBZ-5/82						
		carcass	DBZ-5/82	width 68 mm depth 52 mm height 720 mm	BI KLN BE OLS BU WE DMI WIEL DW WISE KA WISP KAS SZ	Royal CAPITAL Sentima TRAFFIC Classic Modern 	[11] [22] [25] [14] [15] [16] [34] [35] [36] [3]P [4] [7] [9] [12]P [4-] [5-] [6-] [7-] Dekorado Ledo Melos Rosa Diona Hedar Telesto FAL KAR POR EKR TAF_MDF	is to extend side of lower cabinet finishing assembly, of which depth is 508 mm application example shown in catalogue System in a Nutshell p. 63
		DBZ-56/82						
		carcass	DBZ-56/82	width 16 mm depth 560 mm height 720 mm	BI KLN BE OLS BU WE DMI WIEL DW WISE KA WISP KAS SZ	Royal CAPITAL Sentima TRAFFIC Classic Modern 	[11] [22] [25] [14] [15] [16] [34] [35] [36] [3]P [4] [7] [9] [12]P [4-] [5-] [6-] [7-] Dekorado Ledo Melos Rosa Diona Hedar Telesto FAL KAR POR EKR TAF_MDF	is to extend side of lower cabinet finishing assembly, of which depth is 508 mm application example shown in catalogue System in a Nutshell p. 63
		DI-5/82-B						
		carcass	DI-5/82	width 50 mm depth 560 mm height 720 mm	BI WE BE WIEL BU WISE DMI WISP DW SZ KLN OLS	Royal Sentima Classic 	[14] [15] [3]P [4] [7] [9] [12]P Dekorado Ledo Rosa FAL KAR POR	pilaster may be applied between cabinets or at end assembly from left or right side
		door	713/50-I					
	DSY-45/82							
	  x 4	carcass	DSY-45/82	width 450 mm depth 508 mm height 820 mm	BU DW KA OLS WIEL WISE WISP	Royal Sentima	[22] [14] [15] [16] [3]P [4] [7] [9] [12]P	wicker baskets are sold in set of basket + guides wicker baskets are ordered separately
DSY-60/82								
  x 4		carcass	DSY-60/82	width 600 mm depth 508 mm height 820 mm	BU DW KA OLS WIEL WISE WISP	Royal Sentima	[22] [14] [15] [16] [3]P [4] [7] [9] [12]P	wicker baskets are sold in set of basket + guides wicker baskets are ordered separately

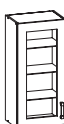
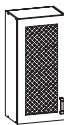
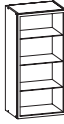
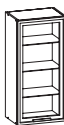



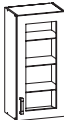
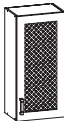
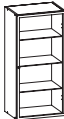
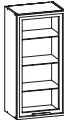





G-15/72		packages	carcass dimensions		carcass colours		available in	comments
	carcass	G-15/72	width	150 mm	BI	KLN	<i>Royal</i>	[11] [22] [25] [14] [15] [16]
			depth	300 mm	BE	OLS	CAPITAL	[34] [35] [36]
			height	716 mm	BU	WE	<i>Sentima</i>	[3]P [4] [7] [9] [12]P
					DMI	WIEL	TRAFFIC	[4-] [5-] [6-] [7-]
				DW	WISE	<i>Classic</i>	<i>Dekorado Ledo Melos Rosa</i>	
				KA	WISP	Modern	Diona Hedar Telesto	
				KAS	SZ	BRW	FAL KAR POR EKR TAF_MDF	
G-15/95		packages	carcass dimensions		carcass colours		available in	comments
	carcass	G-15/95	width	150 mm	BI	KLN	<i>Royal</i>	[11] [22] [25] [14] [15] [16]
			depth	300 mm	BE	OLS	CAPITAL	[34] [35] [36]
			height	946 mm	BU	WE	<i>Sentima</i>	[3]P [4] [7] [9] [12]P
					DMI	WIEL	TRAFFIC	[4-] [5-] [6-] [7-]
				DW	WISE	<i>Classic</i>	<i>Dekorado Ledo Melos Rosa</i>	
				KA	WISP	Modern	Diona Hedar Telesto	
				KAS	SZ	BRW	FAL KAR POR EKR TAF_MDF	
G-30/54-L		packages	carcass dimensions		carcass colours		available in	comments
4 	carcass	G-30/54	width	300 mm	KA		<i>Royal</i>	[22]
	door	534/296-L	depth	300 mm				
			height	537 mm				
G-30/54-P		packages	carcass dimensions		carcass colours		available in	comments
4 	carcass	G-30/54	width	300 mm	KA		<i>Royal</i>	[22]
	door	534/296-P	depth	300 mm				
			height	537 mm				
G-30/57-L		packages	carcass dimensions		carcass colours		available in	comments
5 	carcass	G-30/57	width	300 mm	BU		<i>Royal</i>	[14] [15] [16]
	door	570/296 (-L)	depth	300 mm	DW		<i>Sentima</i>	[3]P [4] [7] [9] [12]P
			height	573 mm	OLS			
					WIEL			
				WISP				
G-30/57-P		packages	carcass dimensions		carcass colours		available in	comments
5 	carcass	G-30/57	width	300 mm	BU		<i>Royal</i>	[14] [15] [16]
	door	570/296 (-P)	depth	300 mm	DW		<i>Sentima</i>	[3]P [4] [7] [9] [12]P
			height	573 mm	OLS			
					WIEL			
				WISP				
G-30/72-L		packages	carcass dimensions		carcass colours		available in	comments
	carcass	G-30/72	width	300 mm	BI	KLN	<i>Royal</i>	[11] [22] [25] [14] [15] [16]
	door	713/296 (-L)	depth	300 mm	BE	OLS	CAPITAL	[34] [35] [36]
			height	716 mm	BU	WE	<i>Sentima</i>	[3]P [4] [7] [9] [12]P
					DMI	WIEL	TRAFFIC	[4-] [5-] [6-] [7-]
				DW	WISE	<i>Classic</i>	<i>Dekorado Ledo Melos Rosa</i>	
				KA	WISP	Modern	Diona Hedar Telesto	
				KAS	SZ	BRW	FAL KAR POR EKR TAF_MDF	
G-30/72-P		packages	carcass dimensions		carcass colours		available in	comments
	carcass	G-30/72	width	300 mm	BI	KLN	<i>Royal</i>	[11] [22] [25] [14] [15] [16]
	door	713/296 (-P)	depth	300 mm	BE	OLS	CAPITAL	[34] [35] [36]
			height	716 mm	BU	WE	<i>Sentima</i>	[3]P [4] [7] [9] [12]P
					DMI	WIEL	TRAFFIC	[4-] [5-] [6-] [7-]
				DW	WISE	<i>Classic</i>	<i>Dekorado Ledo Melos Rosa</i>	
				KA	WISP	Modern	Diona Hedar Telesto	
				KAS	SZ	BRW	FAL KAR POR EKR TAF_MDF	





G-30/95-L		packages	carcass dimensions		carcass colours		available in	comments
	carcass	G-30/95	width	300 mm	BI	KLN	<i>Royal</i> CAPITAL <i>Sentima</i> TRAFFIC <i>Classic</i> Modern 	[11] [22] [25] [14] [15] [16] [34] [35] [36] [3]P [4] [7] [9] [12]P [4-] [5-] [6-] [7-] Dekorado Ledo Melos Rosa Diona Hedar Telesto FAL KAR POR EKR TAF_MDF
	door	943/296 (-L)	depth	300 mm	BE	OLS		
			height	946 mm	BU	WE		
					DMI	WIEL		
					DW	WISE		
					KA	WISP		
					KAS	SZ		
G-30/95-P		packages	carcass dimensions		carcass colours		available in	comments
	carcass	G-30/95	width	300 mm	BI	KLN	<i>Royal</i> CAPITAL <i>Sentima</i> TRAFFIC <i>Classic</i> Modern 	[11] [22] [25] [14] [15] [16] [34] [35] [36] [3]P [4] [7] [9] [12]P [4-] [5-] [6-] [7-] Dekorado Ledo Melos Rosa Diona Hedar Telesto FAL KAR POR EKR TAF_MDF
	door	943/296 (-P)	depth	300 mm	BE	OLS		
			height	946 mm	BU	WE		
					DMI	WIEL		
					DW	WISE		
					KA	WISP		
					KAS	SZ		
GL-30/72/95-L		packages	carcass dimensions		carcass colours		available in	comments
	carcass	GL-30/72/95	width	300 mm	BI	OLS	<i>Royal</i> <i>Sentima</i> <i>Classic</i> 	[22] [15] [4] [7] [12]P Ledo Melos Rosa FAL KAR POR
	door	943/296-LE	depth	300 mm	BE	WE		
			height	946 mm	BU	WIEL		
					DMI	WISE		
					DW	WISP		
					KA	SZ		
					KLN			
GP-30/72/95-P		packages	carcass dimensions		carcass colours		available in	comments
	carcass	GP-30/72/95	width	300 mm	BI	OLS	<i>Royal</i> <i>Sentima</i> <i>Classic</i> 	[22] [15] [4] [7] [12]P Ledo Melos Rosa FAL KAR POR
	door	943/296-PE	depth	300 mm	BE	WE		
			height	946 mm	BU	WIEL		
					DMI	WISE		
					DW	WISP		
					KA	SZ		
					KLN			
G-45/54-L		packages	carcass dimensions		carcass colours		available in	comments
4 	carcass	G-45/54	width	450 mm	KA		<i>Royal</i>	[22]
	door	534/446-L	depth	300 mm				
			height	537 mm				
G-45/54-P		packages	carcass dimensions		carcass colours		available in	comments
4 	carcass	G-45/54	width	450 mm	KA		<i>Royal</i>	[22]
	door	534/446-P	depth	300 mm				
			height	537 mm				
G-45/57-L		packages	carcass dimensions		carcass colours		available in	comments
5 	carcass	G-45/57	width	450 mm	BU		<i>Royal</i> <i>Sentima</i>	[14] [15] [16] [3]P [4] [7] [9] [12]P
	door	570/446 (-L)	depth	300 mm	DW	OLS		
			height	573 mm	WIEL	WISP		
G-45/57-P		packages	carcass dimensions		carcass colours		available in	comments
5 	carcass	G-45/57	width	450 mm	BU		<i>Royal</i> <i>Sentima</i>	[14] [15] [16] [3]P [4] [7] [9] [12]P
	door	570/446 (-P)	depth	300 mm	DW	OLS		
			height	573 mm	WIEL	WISP		









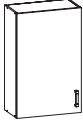
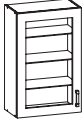
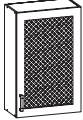

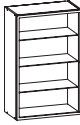

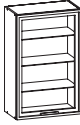

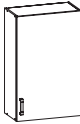
G-45/72-L		packages	carcass dimensions		carcass colours		available in	comments
	carcass	G-45/72	width	450 mm	BI	KLN	<i>Royal</i> CAPITAL <i>Sentima</i> TRAFFIC <i>Classic</i> Modern BRW	[11] [22] [25] [14] [15] [16] [34] [35] [36] [3]P [4] [7] [9] [12]P [4-] [5-] [6-] [7-] <i>Dekorado Ledo Melos Rosa</i> Diona Hedar Telesto <i>FAL KAR POR EKR TAF_MDF</i>
	door	713/446 (-L)	depth	300 mm	BE	OLS		
			height	716 mm	BU	WE		
					DMI	WIEL		
					DW	WISE		
					KA	WISP		
					KAS	SZ		
G-45/72-LV		packages	carcass dimensions		carcass colours		available in	comments
	carcass	G-45/72	width	450 mm	BI	KLN	<i>Royal</i> CAPITAL <i>Sentima</i> TRAFFIC <i>Classic</i> Modern BRW	[11] [22] [25] [14] [15] [16] [34] [35] [3]P [4] [7] [9] [12]P [5-] [6-] [7-] <i>Dekorado Ledo Melos Rosa</i> Telesto <i>FAL KAR POR EKR TAF_MDF</i>
	door	713/446-V (-LV)	depth	300 mm	BE	OLS		
	glazing	713/446-V*	height	716 mm	BU	WE		* concerns doors, in which glazing is not factory fitted
					DMI	WIEL		
					DW	WISE		
					KA	WISP		
					KAS	SZ		
G-45/72-LH		packages	carcass dimensions		carcass colours		available in	comments
	carcass	G-45/72	width	450 mm	BI	KLN	<i>Royal</i>	[11] [22] [25] [15] [16]
	door	713/446-H (-LH)	depth	300 mm	BE	OLS		
			height	716 mm	BU	WE		
					DMI	WIEL		
					DW	WISE		
					KA	WISP		
					KAS	SZ		
G-45/72-LVA		packages	carcass dimensions		carcass colours		available in	comments
	carcass	G-45/72	width	450 mm	BI	KLN	CAPITAL TRAFFIC Modern BRW	[34] [35] [36] [4-] [5-] [7-] Diona Hedar Telesto EKR TAF_MDF
	door	713/446-VA	depth	300 mm	BE	OLS		
			height	716 mm	BU	WE		
					DMI	WIEL		
					DW	WISE		
					KA	WISP		
					KAS	SZ		
G-45/72-LVA3		packages	carcass dimensions		carcass colours		available in	comments
	carcass	G-45/72	width	450 mm	BI	KLN	CAPITAL TRAFFIC Modern BRW	[34] [35] [36] [4-] [5-] [7-] Diona Hedar Telesto EKR TAF_MDF
	door	713/446-LVA3	depth	300 mm	BE	OLS		
			height	716 mm	BU	WE		
					DMI	WIEL		
					DW	WISE		
					KA	WISP		
					KAS	SZ		
G-45/72-P		packages	carcass dimensions		carcass colours		available in	comments
	carcass	G-45/72	width	450 mm	BI	KLN	<i>Royal</i> CAPITAL <i>Sentima</i> TRAFFIC <i>Classic</i> Modern BRW	[11] [22] [25] [14] [15] [16] [34] [35] [36] [3]P [4] [7] [9] [12]P [4-] [5-] [6-] [7-] <i>Dekorado Ledo Melos Rosa</i> Diona Hedar Telesto <i>FAL KAR POR EKR TAF_MDF</i>
	door	713/446 (-P)	depth	300 mm	BE	OLS		
			height	716 mm	BU	WE		
					DMI	WIEL		
					DW	WISE		
					KA	WISP		
					KAS	SZ		
G-45/72-PV		packages	carcass dimensions		carcass colours		available in	comments
	carcass	G-45/72	width	450 mm	BI	KLN	<i>Royal</i> CAPITAL <i>Sentima</i> TRAFFIC <i>Classic</i> Modern BRW	[11] [22] [25] [14] [15] [16] [34] [35] [3]P [4] [7] [9] [12]P [5-] [6-] [7-] <i>Dekorado Ledo Melos Rosa</i> Telesto <i>FAL KAR POR EKR TAF_MDF</i>
	door	713/446-V (-PV)	depth	300 mm	BE	OLS		
	glazing	713/446-V*	height	716 mm	BU	WE		* concerns doors, in which glazing is not factory fitted
					DMI	WIEL		
					DW	WISE		
					KA	WISP		
					KAS	SZ		
G-45/72-PH		packages	carcass dimensions		carcass colours		available in	comments
	carcass	G-45/72	width	450 mm	BI	KLN	<i>Royal</i>	[11] [22] [25] [15] [16]
	door	713/446-H (-PH)	depth	300 mm	BE	OLS		
			height	716 mm	BU	WE		
					DMI	WIEL		
					DW	WISE		
					KA	WISP		
					KAS	SZ		

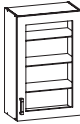

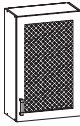
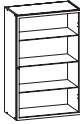

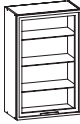
G-45/72-PVA		packages	carcass dimensions		carcass colours		available in	comments
	carcass	G-45/72	width	450 mm	BI	KLN	CAPITAL	[34] [35] [36]
	door	713/446-VA	depth	300 mm	BE	OLS	TRAFFIC	[4-] [5-] [7-]
			height	716 mm	BU	WE	Modern	Diona Hedar Telesto
					DMI	WIEL	BRW	EKR TAF_MDF
					DW	WISE		
					KA	WISP		
					KAS	SZ		
G-45/72-PVA3		packages	carcass dimensions		carcass colours		available in	comments
	carcass	G-45/72	width	450 mm	BI	KLN	CAPITAL	[34] [35] [36]
	door	713/446-PVA3	depth	300 mm	BE	OLS	TRAFFIC	[4-] [5-] [7-]
			height	716 mm	BU	WE	Modern	Diona Hedar Telesto
					DMI	WIEL	BRW	EKR TAF_MDF
					DW	WISE		
					KA	WISP		
					KAS	SZ		
G-45/95-L		packages	carcass dimensions		carcass colours		available in	comments
	carcass	G-45/95	width	450 mm	BI	KLN	<i>Royal</i>	[11] [22] [25] [14] [15] [16]
	door	943/446 (-L)	depth	300 mm	BE	OLS	CAPITAL	[34] [35] [36]
			height	946 mm	BU	WE	<i>Sentima</i>	[3]P [4] [7] [9] [12]P
					DMI	WIEL	TRAFFIC	[4-] [5-] [6-] [7-]
					DW	WISE	<i>Classic</i>	<i>Dekorado Ledo Melos Rosa</i>
					KA	WISP	Modern	Diona Hedar Telesto
					KAS	SZ	BRW	FAL KAR POR EKR TAF_MDF
G-45/95-LV		packages	carcass dimensions		carcass colours		available in	comments
	carcass	G-45/95	width	450 mm	BI	KLN	<i>Royal</i>	[11] [22] [25] [14] [15] [16]
	door	943/446-V (-LV)	depth	300 mm	BE	OLS	CAPITAL	[34] [35]
	glazing	943/446-V*	height	946 mm	BU	WE	<i>Sentima</i>	[3]P [4] [7] [9] [12]P
					DMI	WIEL	TRAFFIC	[5-] [6-] [7-]
					DW	WISE	<i>Classic</i>	<i>Dekorado Ledo Melos Rosa</i>
					KA	WISP	Modern	Telesto
					KAS	SZ	BRW	FAL KAR POR EKR TAF_MDF
G-45/95-LH		packages	carcass dimensions		carcass colours		available in	comments
	carcass	G-45/95	width	450 mm	BI	KLN	<i>Royal</i>	[11] [22] [25] [15] [16]
	door	943/446-H (-LH)	depth	300 mm	BE	OLS		
			height	946 mm	BU	WE		
					DMI	WIEL		
					DW	WISE		
					KA	WISP		
					KAS	SZ		
G-45/95-LVA		packages	carcass dimensions		carcass colours		available in	comments
	carcass	G-45/95	width	450 mm	BI	KLN	CAPITAL	[34] [35] [36]
	door	943/446-VA	depth	300 mm	BE	OLS	TRAFFIC	[4-] [5-] [7-]
			height	946 mm	BU	WE	Modern	Diona Hedar Telesto
					DMI	WIEL	BRW	EKR TAF_MDF
					DW	WISE		
					KA	WISP		
					KAS	SZ		
G-45/95-LVA3		packages	carcass dimensions		carcass colours		available in	comments
	carcass	G-45/95	width	450 mm	BI	KLN	CAPITAL	[34] [35] [36]
	door	943/446-LVA3	depth	300 mm	BE	OLS	TRAFFIC	[4-] [5-] [7-]
			height	946 mm	BU	WE	Modern	Diona Hedar Telesto
					DMI	WIEL	BRW	EKR TAF_MDF
					DW	WISE		
					KA	WISP		
					KAS	SZ		
G-45/95-P		packages	carcass dimensions		carcass colours		available in	comments
	carcass	G-45/95	width	450 mm	BI	KLN	<i>Royal</i>	[11] [22] [25] [14] [15] [16]
	door	943/446 (-P)	depth	300 mm	BE	OLS	CAPITAL	[34] [35] [36]
			height	946 mm	BU	WE	<i>Sentima</i>	[3]P [4] [7] [9] [12]P
					DMI	WIEL	TRAFFIC	[4-] [5-] [6-] [7-]
					DW	WISE	<i>Classic</i>	<i>Dekorado Ledo Melos Rosa</i>
					KA	WISP	Modern	Diona Hedar Telesto
					KAS	SZ	BRW	FAL KAR POR EKR TAF_MDF

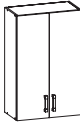



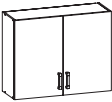
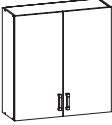

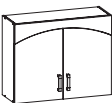

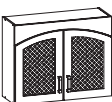





G-45/95-PV		packages	carcass dimensions		carcass colours		available in	comments	
	carcass	G-45/95	width	450 mm	BI	KLN	<i>Royal</i> CAPITAL <i>Sentima</i> TRAFFIC <i>Classic</i> Modern <i>BRW</i>	[11] [22] [25] [14] [15] [16] [34] [35] [3]P [4] [7] [9] [12]P [5-] [6-] [7-] Dekorado Ledo Melos Rosa Telesto FAL KAR POR EKR TAF_MDF	* concerns doors, in which glazing is not factory fitted
	door	943/446-V (-PV)	depth	300 mm	BE	OLS			
	glazing	943/446-V*	height	946 mm	BU	WE			
				DMI	WIEL				
				DW	WISE				
				KA	WISP				
				KAS	SZ				
G-45/95-PH		packages	carcass dimensions		carcass colours		available in	comments	
	carcass	G-45/95	width	450 mm	BI	KLN	<i>Royal</i>	[11] [22] [25] [15] [16]	
	door	943/446-H (-PH)	depth	300 mm	BE	OLS			
			height	946 mm	BU	WE			
				DMI	WIEL				
				DW	WISE				
				KA	WISP				
				KAS	SZ				
G-45/95-PVA		packages	carcass dimensions		carcass colours		available in	comments	
	carcass	G-45/95	width	450 mm	BI	KLN	CAPITAL TRAFFIC Modern <i>BRW</i>	[34] [35] [36] [4-] [5-] [7-] Diona Hedar Telesto EKR TAF_MDF	
	door	943/446-VA	depth	300 mm	BE	OLS			
			height	946 mm	BU	WE			
				DMI	WIEL				
				DW	WISE				
				KA	WISP				
				KAS	SZ				
G-45/95-PVA3		packages	carcass dimensions		carcass colours		available in	comments	
	carcass	G-45/95	width	450 mm	BI	KLN	CAPITAL TRAFFIC Modern <i>BRW</i>	[34] [35] [36] [4-] [5-] [7-] Diona Hedar Telesto EKR TAF_MDF	
	door	943/446-PVA3	depth	300 mm	BE	OLS			
			height	946 mm	BU	WE			
				DMI	WIEL				
				DW	WISE				
				KA	WISP				
				KAS	SZ				
G-60/54-L		packages	carcass dimensions		carcass colours		available in	comments	
4 	carcass	G-60/54	width	600 mm	KA		<i>Royal</i>	[22]	
	door	534/596-L	depth	300 mm					
			height	537 mm					
G-60/54-P		packages	carcass dimensions		carcass colours		available in	comments	
4 	carcass	G-60/54	width	600 mm	KA		<i>Royal</i>	[22]	
	door	534/596-P	depth	300 mm					
			height	537 mm					
G-60/54-L/P		packages	carcass dimensions		carcass colours		available in	comments	
4 	carcass	G-60/54	width	600 mm	KA		<i>Royal</i>	[22]	
	doors	534/296-L 534/296-P	depth	300 mm					
			height	537 mm					
G-60/57-L		packages	carcass dimensions		carcass colours		available in	comments	
5 	carcass	G-60/57	width	600 mm	BU		<i>Royal</i> <i>Sentima</i>	[14] [15] [16] [3] [3]P [4] [7] [9] [12]P	
	door	570/596 (-L)	depth	300 mm	DW				
			height	573 mm	OLS				
				WIEL					
				WISP					









G-60/57-P		packages	carcass dimensions		carcass colours		appear in	comments
		carcass	G-60/57	width	600 mm	BU	<i>Royal</i>	[14] [15] [16]
		door	570/596 (-P)	depth	300 mm	DW	<i>Sentima</i>	[3] [3]P [4] [7] [9] [12]P
				height	573 mm	OLS WIEL WISP		
G-60/57-L/P		packages	carcass dimensions		carcass colours		appear in	comments
		carcass	G-60/57	width	600 mm	BU	<i>Royal</i>	[14] [15] [16]
		doors	570/596 (-L) 570/596 (-P)	depth	300 mm	DW	<i>Sentima</i>	[3] [3]P [4] [7] [9] [12]P
				height	573 mm	OLS WIEL WISP		
G-60/72-L		packages	carcass dimensions		carcass colours		appear in	comments
		carcass	G-60/72	width	600 mm	BI KLN	<i>Royal</i>	[11] [22] [25] [14] [15] [16]
		door	713/596 (-L)	depth	300 mm	BE OLS	CAPITAL	[34] [35] [36]
				height	716 mm	BU WE DMI WIEL DW WISE KA WISP KAS SZ	<i>Sentima</i> TRAFFIC <i>Classic</i> Modern BRW	[3]P [4] [7] [9] [12]P [4-] [5-] [6-] [7-] <i>Dekorado Ledo Melos Rosa</i> Diona Hedar Telesto <i>FAL KAR POR EKR TAF_MDF</i>
G-60/72-LV		packages	carcass dimensions		carcass colours		appear in	comments
		carcass	G-60/72	width	600 mm	BI KLN	<i>Royal</i>	[11] [22] [25] [14] [15] [16]
		door	713/596-V (-LV)	depth	300 mm	BE OLS	CAPITAL	[34] [35]
		glazing	713/596-V*	height	716 mm	BU WE DMI WIEL DW WISE KA WISP KAS SZ	<i>Sentima</i> TRAFFIC <i>Classic</i> Modern BRW	[3]P [4] [7] [9] [12]P [5-] [6-] [7-] <i>Dekorado Ledo Melos Rosa</i> Telesto <i>FAL KAR POR EKR TAF_MDF</i>
								* concerns doors, in which glazing is not factory fitted
G-60/72-LH		packages	carcass dimensions		carcass colours		appear in	comments
		carcass	G-60/72	width	600 mm	BI KLN	<i>Royal</i>	[11] [22] [25] [15] [16]
		door	713/596-H (-LH)	depth	300 mm	BE OLS		
				height	716 mm	BU WE DMI WIEL DW WISE KA WISP KAS SZ		
G-60/72-LVA		packages	carcass dimensions		carcass colours		appear in	comments
		carcass	G-60/72	width	600 mm	BI KLN	CAPITAL	[34] [35] [36]
		door	713/596-VA	depth	300 mm	BE OLS	TRAFFIC	[4-] [5-] [7-]
				height	716 mm	BU WE DMI WIEL DW WISE KA WISP KAS SZ	Modern BRW	Diona Hedar Telesto EKR TAF_MDF
G-60/72-LVA3		packages	carcass dimensions		carcass colours		appear in	comments
		carcass	G-60/72	width	600 mm	BI KLN	CAPITAL	[34] [35] [36]
		door	713/596-LVA3	depth	300 mm	BE OLS	TRAFFIC	[4-] [5-] [7-]
				height	716 mm	BU WE DMI WIEL DW WISE KA WISP KAS SZ	Modern BRW	Diona Hedar Telesto EKR TAF_MDF
G-60/72-P		packages	carcass dimensions		carcass colours		appear in	comments
		carcass	G-60/72	width	600 mm	BI KLN	<i>Royal</i>	[11] [22] [25] [14] [15] [16]
		door	713/596 (-P)	depth	300 mm	BE OLS	CAPITAL	[34] [35] [36]
				height	716 mm	BU WE DMI WIEL DW WISE KA WISP KAS SZ	<i>Sentima</i> TRAFFIC <i>Classic</i> Modern BRW	[3]P [4] [7] [9] [12]P [4-] [5-] [6-] [7-] <i>Dekorado Ledo Melos Rosa</i> Diona Hedar Telesto <i>FAL KAR POR EKR TAF_MDF</i>

G-60/72-PV		packages	carcass dimensions		carcass colours		available in	comments	
	carcass	G-60/72	width	600 mm	BI	KLN	<i>Royal</i> CAPITAL <i>Sentima</i> TRAFFIC <i>Classic</i> Modern BRW	[11] [22] [25] [14] [15] [16] [34] [35] [3]P [4] [7] [9] [12]P [5-] [6-] [7-] Dekorado Ledo Melos Rosa Telesto FAL KAR POR EKR TAF_MDF	* concerns doors, in which glazing is not factory fitted
	door	713/596-V (-PV)	depth	300 mm	BE	OLS			
	glazing	713/596-V*	height	716 mm	BU	WE			
					DMI	WIEL			
					DW	WISE			
					KA	WISP			
					KAS	SZ			
G-60/72-PH		packages	carcass dimensions		carcass colours		available in	comments	
	carcass	G-60/72	width	600 mm	BI	KLN	<i>Royal</i> [11] [22] [25] [15] [16]		
	door	713/596-H (-PH)	depth	300 mm	BE	OLS			
			height	716 mm	BU	WE			
					DMI	WIEL			
					DW	WISE			
					KA	WISP			
					KAS	SZ			
G-60/72-PVA		packages	carcass dimensions		carcass colours		available in	comments	
	carcass	G-60/72	width	600 mm	BI	KLN	CAPITAL TRAFFIC Modern BRW	[34] [35] [36] [4-] [5-] [7-] Diona Hedar Telesto EKR TAF_MDF	
	door	713/596-VA	depth	300 mm	BE	OLS			
			height	716 mm	BU	WE			
					DMI	WIEL			
					DW	WISE			
					KA	WISP			
					KAS	SZ			
G-60/72-PVA3		packages	carcass dimensions		carcass colours		available in	comments	
	carcass	G-60/72	width	600 mm	BI	KLN	CAPITAL TRAFFIC Modern BRW	[34] [35] [36] [4-] [5-] [7-] Diona Hedar Telesto EKR TAF_MDF	
	door	713/596-PVA3	depth	300 mm	BE	OLS			
			height	716 mm	BU	WE			
					DMI	WIEL			
					DW	WISE			
					KA	WISP			
					KAS	SZ			
G-60/72-L/P		packages	carcass dimensions		carcass colours		available in	comments	
	carcass	G-60/72	width	600 mm	BI	KLN	<i>Royal</i> CAPITAL <i>Sentima</i> TRAFFIC <i>Classic</i> Modern BRW	[11] [22] [25] [14] [15] [16] [34] [35] [36] [3]P [4] [7] [9] [12]P [4-] [5-] [6-] [7-] Dekorado Ledo Melos Rosa Diona Hedar Telesto FAL KAR POR EKR TAF_MDF	
	doors	713/296 (-L) 713/296 (-P)	depth	300 mm	BE	OLS			
			height	716 mm	BU	WE			
					DMI	WIEL			
					DW	WISE			
					KA	WISP			
					KAS	SZ			
G-60/95-L		packages	carcass dimensions		carcass colours		available in	comments	
	carcass	G-60/95	width	600 mm	BI	KLN	<i>Royal</i> CAPITAL <i>Sentima</i> TRAFFIC <i>Classic</i> Modern BRW	[11] [22] [25] [14] [15] [16] [34] [35] [36] [3]P [4] [7] [9] [12]P [4-] [5-] [6-] [7-] Dekorado Ledo Melos Rosa Diona Hedar Telesto FAL KAR POR EKR TAF_MDF	
	door	943/596 (-L)	depth	300 mm	BE	OLS			
			height	946 mm	BU	WE			
					DMI	WIEL			
					DW	WISE			
					KA	WISP			
					KAS	SZ			
G-60/95-LV		packages	carcass dimensions		carcass colours		available in	comments	
	carcass	G-60/95	width	600 mm	BI	KLN	<i>Royal</i> CAPITAL <i>Sentima</i> TRAFFIC <i>Classic</i> Modern BRW	[11] [22] [25] [14] [15] [16] [34] [35] [3]P [4] [7] [9] [12]P [5-] [6-] [7-] Dekorado Ledo Melos Rosa Telesto FAL KAR POR EKR TAF_MDF	* concerns doors, in which glazing is not factory fitted
	door	943/596-V (-LV)	depth	300 mm	BE	OLS			
	glazing	943/596-V*	height	946 mm	BU	WE			
					DMI	WIEL			
					DW	WISE			
					KA	WISP			
					KAS	SZ			
G-60/95-LH		packages	carcass dimensions		carcass colours		available in	comments	
	carcass	G-60/95	width	600 mm	BI	KLN	<i>Royal</i> [11] [22] [25] [15] [16]		
	door	943/596-H (-LH)	depth	300 mm	BE	OLS			
			height	946 mm	BU	WE			
					DMI	WIEL			
					DW	WISE			
					KA	WISP			
					KAS	SZ			





G-60/95-LVA		packages	carcass dimensions		carcass colours		available in	comments
	carcass	G-60/95	width	600 mm	BI	KLN	CAPITAL TRAFFIC Modern 	[34] [35] [36] [4-] [5-] [7-] Diona Hedar Telesto EKR TAF_MDF
	door	943/596-VA	depth	300 mm	BE	OLS		
			height	946 mm	BU	WE		
					DMI	WIEL		
					DW	WISE		
					KA	WISP		
					KAS	SZ		
G-60/95-LVA3		packages	carcass dimensions		carcass colours		available in	comments
	carcass	G-60/95	width	600 mm	BI	KLN	CAPITAL TRAFFIC Modern 	[34] [35] [36] [4-] [5-] [7-] Diona Hedar Telesto EKR TAF_MDF
	door	943/596-LVA3	depth	300 mm	BE	OLS		
			height	946 mm	BU	WE		
					DMI	WIEL		
					DW	WISE		
					KA	WISP		
					KAS	SZ		
G-60/95-P		packages	carcass dimensions		carcass colours		available in	comments
	carcass	G-60/95	width	600 mm	BI	KLN	<i>Royal</i> CAPITAL <i>Sentima</i> TRAFFIC <i>Classic</i> Modern 	[11] [22] [25] [14] [15] [16] [34] [35] [36] [3]P [4] [7] [9] [12]P [4-] [5-] [6-] [7-] Dekorado Ledo Melos Rosa Diona Hedar Telesto FAL KAR POR EKR TAF_MDF
	door	943/596 (-P)	depth	300 mm	BE	OLS		
			height	946 mm	BU	WE		
					DMI	WIEL		
					DW	WISE		
					KA	WISP		
					KAS	SZ		
G-60/95-PV		packages	carcass dimensions		carcass colours		available in	comments
	carcass	G-60/95	width	600 mm	BI	KLN	<i>Royal</i> CAPITAL <i>Sentima</i> TRAFFIC <i>Classic</i> Modern 	[11] [22] [25] [14] [15] [16] [34] [35] [3]P [4] [7] [9] [12]P [5-] [6-] [7-] Dekorado Ledo Melos Rosa Telesto FAL KAR POR EKR TAF_MDF
	door	943/596-V (-PV)	depth	300 mm	BE	OLS		
	glazing	943/596-V*	height	946 mm	BU	WE		* concerns doors, in which glazing is not factory mounted
					DMI	WIEL		
					DW	WISE		
					KA	WISP		
					KAS	SZ		
G-60/95-PH		packages	carcass dimensions		carcass colours		available in	comments
	carcass	G-60/95	width	600 mm	BI	KLN	<i>Royal</i>	[11] [22] [25] [15] [16]
	door	943/596-H (-PH)	depth	300 mm	BE	OLS		
			height	946 mm	BU	WE		
					DMI	WIEL		
					DW	WISE		
					KA	WISP		
					KAS	SZ		
G-60/95-PVA		packages	carcass dimensions		carcass colours		available in	comments
	carcass	G-60/95	width	600 mm	BI	KLN	CAPITAL TRAFFIC Modern 	[34] [35] [36] [4-] [5-] [7-] Diona Hedar Telesto EKR TAF_MDF
	door	943/596-VA	depth	300 mm	BE	OLS		
			height	946 mm	BU	WE		
					DMI	WIEL		
					DW	WISE		
					KA	WISP		
					KAS	SZ		
G-60/95-PVA3		packages	carcass dimensions		carcass colours		available in	comments
	carcass	G-60/95	width	600 mm	BI	KLN	CAPITAL TRAFFIC Modern 	[34] [35] [36] [4-] [5-] [7-] Diona Hedar Telesto EKR TAF_MDF
	door	943/596-PVA3	depth	300 mm	BE	OLS		
			height	946 mm	BU	WE		
					DMI	WIEL		
					DW	WISE		
					KA	WISP		
					KAS	SZ		
G-60/95-L/P		packages	carcass dimensions		carcass colours		available in	comments
	carcass	G-60/95	width	600 mm	BI	KLN	<i>Royal</i> CAPITAL <i>Sentima</i> TRAFFIC <i>Classic</i> Modern 	[11] [22] [25] [14] [15] [16] [34] [35] [36] [3]P [4] [7] [9] [12]P [4-] [5-] [6-] [7-] Dekorado Ledo Melos Rosa Diona Hedar Telesto FAL KAR POR EKR TAF_MDF
	doors	943/296 (-L) 943/296 (-P)	depth	300 mm	BE	OLS		
			height	946 mm	BU	WE		
					DMI	WIEL		
					DW	WISE		
					KA	WISP		
					KAS	SZ		

G-90/72-L/P		packages	carcass dimensions		carcass colours		available in	comments
	carcass	G-90/72	width	900 mm	BI	KLN	<i>Royal</i> CAPITAL <i>Sentima</i> TRAFFIC <i>Classic</i> Modern BRW	[11] [22] [25] [14] [15] [16] [34] [35] [36] [3]P [4] [7] [9] [12]P [4-] [5-] [6-] [7-] <i>Dekorado Ledo Melos Rosa</i> Diona Hedar Telesto <i>FAL KAR POR</i> EKR TAF_MDF
	doors	713/446 (-L) 713/446 (-P)	depth	300 mm	BE	OLS		
			height	716 mm	BU	WE		
					DMI	WIEL		
					DW	WISE		
					KA	WISP		
					KAS	SZ		
G-90/95-L/P		packages	carcass dimensions		carcass colours		available in	comments
	carcass	G-90/95	width	900 mm	BU	WISP	<i>Royal</i> CAPITAL <i>Sentima</i> TRAFFIC	[11] [22] [25] [14] [15] [16] [34] [35] [36] [3]P [4] [7] [9] [12]P [4-] [5-] [6-] [7-]
	doors	943/446 (-L) 943/446 (-P)	depth	300 mm	DW			
			height	946 mm	KA			
					KAS			
					OLS			
					WIEL			
					WISE			
GB/4-90/72-LV/PV/B		packages	carcass dimensions		carcass colours		available in	comments
	carcass	GB/4-90/72	width	900 mm	KA		<i>Royal</i>	[22]
	doors	633/446-LVE 633/446-PVE 176/896-E	depth	300 mm				
			height	716 mm				
GB/4-90/72-LH/PH/B		packages	carcass dimensions		carcass colours		available in	comments
	carcass	GB/4-90/72	width	900 mm	KA		<i>Royal</i>	[22]
	doors	633/446-LHE 633/446-PHE 176/896-E	depth	300 mm				
			height	716 mm				
GB/5-90/72-L/P/B		packages	carcass dimensions		carcass colours		available in	comments
	carcass	GB/5-90/72	width	900 mm	BI	WE	<i>Royal</i> <i>Classic</i> BRW	[14] [15] <i>Ledo Melos Rosa</i> <i>FAL KAR POR</i>
	doors	621/446-LE* (-LGE*) 621/446-PE* (-PGE*) 140/896-E	depth	300 mm	BE	WIEL		
			height	716 mm	BU	WISE		
					DMI	WISP		
					DW	SZ		
					KLN			
					OLS			
GB/5-90/72-LV/PV/B		packages	carcass dimensions		carcass colours		available in	comments
	carcass	GB/5-90/72	width	900 mm	BI	WE	<i>Royal</i> <i>Sentima</i> <i>Classic</i> BRW	[14] [15] [4] [7] [12]P <i>Ledo Melos Rosa</i> <i>FAL KAR POR</i>
	doors	621/446-LVE* 621/446-PVE* 140/896-E	depth	300 mm	BE	WIEL		
	glazing	620/446-LVE** 620/446-PVE**	height	716 mm	BU	WISE		
					DMI	WISP		
					DW	SZ		
					KLN			
					OLS			
GB/5-90/72-LH/PH/B		packages	carcass dimensions		carcass colours		available in	comments
	carcass	GB/5-90/72	width	900 mm	BI	WE	<i>Royal</i>	[15]
	doors	645/446-LVE 645/446-PVE 140/896-E	depth	300 mm	BE	WIEL		
			height	716 mm	BU	WISE		
					DMI	WISP		
					DW	SZ		
					KLN			
					OLS			

GO-45/36-O GO-45/36-OD**		packages	carcass dimensions		carcass colours		available in	comments	
	carcass	GO-45/36	width	450 mm	BI	KLN	<i>Royal</i> CAPITAL <i>Sentima</i> TRAFFIC <i>Classic</i> Modern 	[11] [22] [25] [14] [15] [16] [34] [35] [36] [3]P [4] [7] [9] [12]P [4-] [5-] [6-] [7-] Dekorado Ledo Melos Rosa Diona Hedar Telesto FAL KAR POR EKR TAF_MDF	** available in doors Hedar
	door	355/446-O	depth	300 mm	BE	OLS			
			height	358 mm	BU	WE			
					DMI	WIEL			
					DW	WISE			
					KA	WISP			
					KAS	SZ			
GO-45/36-OV		packages	carcass dimensions		carcass colours		available in	comments	
	carcass	GO-45/36	width	450 mm	BI	KLN	<i>Royal</i> CAPITAL <i>Sentima</i> TRAFFIC <i>Classic</i> Modern 	[11] [22] [25] [14] [15] [16] [34] [35] [3]P [4] [7] [9] [12]P [5-] [6-] [7-] Dekorado Ledo Melos Rosa Telesto FAL KAR POR EKR TAF_MDF	* concerns doors, in which glazing is not factory fitted
	door	355/446-VO	depth	300 mm	BE	OLS			
	glazing	355/446-V*	height	358 mm	BU	WE			
					DMI	WIEL			
					DW	WISE			
					KA	WISP			
					KAS	SZ			
GO-45/36-OH		packages	carcass dimensions		carcass colours		available in	comments	
	carcass	GO-45/36	width	450 mm	BI	KLN	<i>Royal</i>	[11] [22] [25] [15] [16]	
	door	355/446-OH	depth	300 mm	BE	OLS			
			height	358 mm	BU	WE			
					DMI	WIEL			
					DW	WISE			
					KA	WISP			
					KAS	SZ			
GO-45/36-OVA		packages	carcass dimensions		carcass colours		available in	comments	
	carcass	GO-45/36	width	450 mm	BI	KLN	CAPITAL TRAFFIC Modern 	[34] [35] [36] [4-] [5-] [7-] Diona Hedar Telesto EKR TAF_MDF	
	door	355/446-OVA	depth	300 mm	BE	OLS			
			height	358 mm	BU	WE			
					DMI	WIEL			
					DW	WISE			
					KA	WISP			
					KAS	SZ			
GO-45/36-OVA3		packages	carcass dimensions		carcass colours		available in	comments	
	carcass	GO-45/36	width	450 mm	BI	KLN	CAPITAL TRAFFIC Modern 	[34] [35] [36] [4-] [5-] [7-] Diona Hedar Telesto EKR TAF_MDF	
	door	355/446-OVA3	depth	300 mm	BE	OLS			
			height	358 mm	BU	WE			
					DMI	WIEL			
					DW	WISE			
					KA	WISP			
					KAS	SZ			
GO-50/36-O		packages	carcass dimensions		carcass colours		available in	comments	
	carcass	GO-50/36	width	500 mm	BI	WE	<i>Sentima</i> TRAFFIC <i>Classic</i> Modern 	[3]P [4] [7] [9] [12]P [4-] [5-] [6-] [7-] Dekorado Ledo Melos Rosa Diona Hedar Telesto FAL KAR POR EKR TAF_MDF	
	door	355/496-O	depth	300 mm	BE	WIEL			
			height	358 mm	BU	WISE			
					DMI	WISP			
					DW	SZ			
					KLN				
					OLS				
GO-60/36-O GO-60/36-OD**		packages	carcass dimensions		carcass colours		available in	comments	
	carcass	GO-60/36	width	600 mm	BI	KLN	<i>Royal</i> CAPITAL <i>Sentima</i> TRAFFIC <i>Classic</i> Modern 	[11] [22] [25] [14] [15] [16] [34] [35] [36] [3]P [4] [7] [9] [12]P [4-] [5-] [6-] [7-] Dekorado Ledo Melos Rosa Diona Hedar Telesto FAL KAR POR EKR TAF_MDF	** available in doors Hedar
	door	355/596-O	depth	300 mm	BE	OLS			
			height	358 mm	BU	WE			
					DMI	WIEL			
					DW	WISE			
					KA	WISP			
					KAS	SZ			
GO-60/36-OV		packages	carcass dimensions		carcass colours		available in	comments	
	carcass	GO-60/36	width	600 mm	BI	KLN	<i>Royal</i> CAPITAL <i>Sentima</i> TRAFFIC <i>Classic</i> Modern 	[11] [22] [25] [14] [15] [16] [34] [35] [3]P [4] [7] [9] [12]P [5-] [6-] [7-] Dekorado Ledo Melos Rosa Telesto FAL KAR POR EKR TAF_MDF	* concerns doors, in which glazing is not factory fitted
	door	355/596-VO	depth	300 mm	BE	OLS			
	glazing	355/596-V*	height	358 mm	BU	WE			
					DMI	WIEL			
					DW	WISE			
					KA	WISP			
					KAS	SZ			

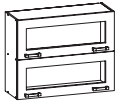
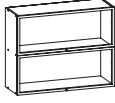
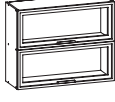
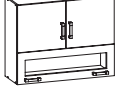
GO-60/36-OH	packages	carcass dimensions	carcass colours	available in	comments
	carcass GO-60/36 door 355/596-OH	width 600 mm depth 300 mm height 358 mm	BI KLN BE OLS BU WE DMI WIEL DW WISE KA WISP KAS SZ	Royal [11] [22] [25] [15] [16]	
GO-60/36-OVA	packages	carcass dimensions	carcass colours	available in	comments
	carcass GO-60/36 door 355/596-OVA	width 600 mm depth 300 mm height 358 mm	BI KLN BE OLS BU WE DMI WIEL DW WISE KA WISP KAS SZ	CAPITAL TRAFFIC Modern BRW	[34] [35] [36] [4-] [5-] [7-] Diona Hedar Telesto EKR TAF_MDF
GO-60/36-OVA3	packages	carcass dimensions	carcass colours	available in	comments
	carcass GO-60/36 door 355/596-OVA3	width 600 mm depth 300 mm height 358 mm	BI KLN BE OLS BU WE DMI WIEL DW WISE KA WISP KAS SZ	CAPITAL TRAFFIC Modern BRW	[34] [35] [36] [4-] [5-] [7-] Diona Hedar Telesto EKR TAF_MDF
GO-90/36-O GO-90/36-OD**	packages	carcass dimensions	carcass colours	available in	comments
	carcass GO-90/36 door 355/896-O	width 900 mm depth 300 mm height 358 mm	BI WE BE WIEL BU WISE DMI WISP DW SZ KLN OLS	CAPITAL TRAFFIC Modern BRW	[34] [35] [36] [4-] [5-] [6-] [7-] Diona Hedar Telesto EKR TAF_MDF ** available in doors Hedar
GO-90/36-OV	packages	carcass dimensions	carcass colours	available in	comments
	carcass GO-90/36 door 355/896-VO glazing 355/896-V*	width 900 mm depth 300 mm height 358 mm	BI WE BE WIEL BU WISE DMI WISP DW SZ KLN OLS	CAPITAL TRAFFIC Modern BRW	[34] [35] [5-] [6-] [7-] Telesto EKR TAF_MDF * concerns doors, in which glazing is not factory fitted
GO-90/36-OVA	packages	carcass dimensions	carcass colours	available in	comments
	carcass GO-90/36 door 355/896-OVA	width 900 mm depth 300 mm height 358 mm	BI WE BE WIEL BU WISE DMI WISP DW SZ KLN OLS	CAPITAL TRAFFIC Modern BRW	[34] [35] [36] [4-] [5-] [7-] Diona Hedar Telesto EKR TAF_MDF
GO-90/36-OVA3	packages	carcass dimensions	carcass colours	available in	comments
	carcass GO-90/36 door 355/896-OVA3	width 900 mm depth 300 mm height 358 mm	BI WE BE WIEL BU WISE DMI WISP DW SZ KLN OLS	CAPITAL TRAFFIC Modern BRW	[34] [35] [36] [4-] [5-] [7-] Diona Hedar Telesto EKR TAF_MDF
GO-120/36-O	packages	carcass dimensions	carcass colours	available in	comments
	carcass GO-120/36 door 355/1196-O	width 1200 mm depth 300 mm height 358 mm	WISE WISP	CAPITAL [34] [35] [36]	

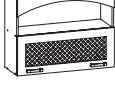





GO-120/36-OV		packages	carcass dimensions		carcass colours	available in	comments
	carcass	GO-120/36	width	1200 mm	WISE	CAPITAL [34] [35]	
	door	355/1196-VO	depth	300 mm	WISP		
			height	358 mm			
GO-120/36-OVA		packages	carcass dimensions		carcass colours	available in	comments
	carcass	GO-120/36	width	1200 mm	WISE	CAPITAL [34] [35] [36]	
	door	355/1196-OVA	depth	300 mm	WISP		
			height	358 mm			
GO-120/36-OVA3		packages	carcass dimensions		carcass colours	available in	comments
	carcass	GO-120/36	width	1200 mm	WISE	CAPITAL [34] [35] [36]	
	door	355/1196-OVA3	depth	300 mm	WISP		
			height	358 mm			
G2O-60/72-2O		packages	carcass dimensions		carcass colours	available in	comments
	carcass	G2O-60/72	width	600 mm	BU	CAPITAL TRAFFIC [34] [35] [36]	
	doors	355/596-O x2	depth	300 mm	DW		
			height	716 mm	OLS WIEL WISE WISP	[4-] [5-] [6-] [7-]	
G2O-60/72-2OV		packages	carcass dimensions		carcass colours	available in	comments
	carcass	G2O-60/72	width	600 mm	BU	CAPITAL TRAFFIC [34] [35]	
	doors	355/596-VO x2	depth	300 mm	DW		
	glazing	355/596-V* x2	height	716 mm	OLS WIEL WISE WISP	[5-] [6-] [7-]	* concerns doors, in which glazing is not factory fitted
G2O-60/72-2OVA		packages	carcass dimensions		carcass colours	available in	comments
	carcass	G2O-60/72	width	600 mm	BU	CAPITAL TRAFFIC [34] [35] [36]	
	doors	355/596-OVA x2	depth	300 mm	DW		
			height	716 mm	OLS WIEL WISE WISP	[4-] [5-] [7-]	
G2O-60/72-2OVA3		packages	carcass dimensions		carcass colours	available in	comments
	carcass	G2O-60/72	width	600 mm	BU	CAPITAL TRAFFIC [34] [35] [36]	
	doors	355/596-OVA3 x2	depth	300 mm	DW		
			height	716 mm	OLS WIEL WISE WISP	[4-] [5-] [7-]	
G2O-90/72-2O		packages	carcass dimensions		carcass colours	available in	comments
	carcass	G2O-90/72	width	900 mm	BU	CAPITAL TRAFFIC [34] [35] [36]	
	doors	355/896-O x2	depth	300 mm	DW		
			height	716 mm	OLS WIEL WISE WISP	[4-] [5-] [6-] [7-]	

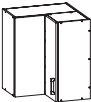

G2O-90/72-2OV		packages	carcass dimensions		carcass colours	available in	comments			
	carcass	G2O-90/72	width	900 mm	BU DW OLS WIEL WISE WISP	CAPITAL TRAFFIC	[34] [35] [5-] [6-] [7-]			
	doors	355/896-VO x2	depth	300 mm						
	glazing	355/896-V* x2	height	716 mm						
G2O-90/72-2OVA		packages	carcass dimensions					carcass colours	available in	comments
	carcass	G2O-90/72	width	900 mm				BU DW OLS WIEL WISE WISP	CAPITAL TRAFFIC	[34] [35] [36] [4-] [5-] [7-]
	doors	355/896-OVA x2	depth	300 mm						
			height	716 mm						
G2O-90/72-2OVA3		packages	carcass dimensions		carcass colours	available in	comments			
	carcass	G2O-90/72	width	900 mm	BU DW OLS WIEL WISE WISP	CAPITAL TRAFFIC	[34] [35] [36] [4-] [5-] [7-]			
	doors	355/896-OVA3 x2	depth	300 mm						
			height	716 mm						
GO2/5-90/72-OV/L/P		packages	carcass dimensions					carcass colours	available in	comments
	carcass	GO2/5-90/72	width	900 mm				BU DW OLS WIEL WISE WISP	<i>Sentima</i> TRAFFIC	[4] [7-]
	doors	284/896-VO 426/446 x2	depth	300 mm						
	glazing	284/896-OV	height	716 mm						
GBO/4-90/72-OV/B		packages	carcass dimensions		carcass colours	available in	comments			
4 	carcass	GBO/4-90/72	width	900 mm	KA KAS	<i>Royal</i>	[11] [22] [25]			
	doors	355/896-VO 176/896-E	depth	300 mm						
			height	716 mm						
GBO/4-90/72-OH/B		packages	carcass dimensions					carcass colours	available in	comments
4 	carcass	GBO/4-90/72	width	900 mm				KA KAS	<i>Royal</i>	[11] [22] [25]
	doors	355/896-OH 176/896-E	depth	300 mm						
			height	716 mm						
GBO/5-90/57-OV/B		packages	carcass dimensions		carcass colours	available in	comments			
5 	carcass	GBO/5-90/57	width	900 mm	BU DW OLS WIEL WISP	<i>Royal</i> <i>Sentima</i>	[14] [15] [4] [7] [12]P			
	doors	284/896-VO 140/896-E	depth	300 mm						
	glazing	284/896-V*	height	573 mm						
GBO/5-90/57-OH/B		packages	carcass dimensions					carcass colours	available in	comments
5 	carcass	GBO/5-90/57	width	900 mm				BU DW OLS WIEL WISP	<i>Royal</i>	[15]
	doors	284/896-OH 140/896-E	depth	300 mm						
			height	573 mm						

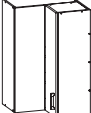
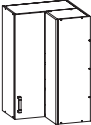





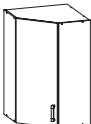
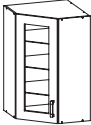
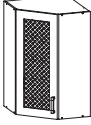
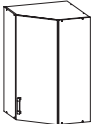
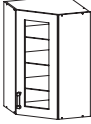
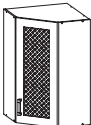

* concerns doors, in which glazing is not factory fitted







glazed door may be ordered in colours Honey Alder ([4]) or Antique Nut ([4],[7-])



* concerns doors, in which glazing is not factory fitted

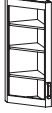



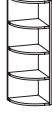



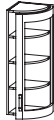

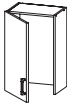

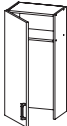

GNW-60/72-L/L		packages	carcass dimensions	carcass colours	available in	comments
	carcass	GNW-60/72	width 600 mm	BU WISP	<i>Royal</i>	[11] [22] [25] [14] [15] [16]
	doors	713/280-N* (-LN*)	depth 600 mm depth of side 300 mm height 716 mm	DW KA KAS OLS WIEL WISE	CAPITAL <i>Sentima</i> TRAFFIC	[34] [35] [36] [3]P [4] [7] [9] [12]P [4-] [5-] [6-] [7-]
* depending on kitchen doors may have different measurements: 713/271-LN - [22] 713/272-N - [25] 713/276-N (-LN) - [11] [14] [15] [16] [34] [35] [36] 713/277-N - [5-] [7-] 713/278-N - [4-] [6-] 713/280-N (-LN) - [4] [7] [12]P 713/284-N - [9] [3]P * package contains door set for corner cabinet GNW-60/72-L/L						
GNW-60/72-P/P		packages	carcass dimensions	carcass colours	available in	comments
	carcass	GNW-60/72	width 600 mm	BU WISP	<i>Royal</i>	[11] [22] [25] [14] [15] [16]
	doors	713/280-N* (-PN*)	depth 600 mm depth of side 300 mm height 716 mm	DW KA KAS OLS WIEL WISE	CAPITAL <i>Sentima</i> TRAFFIC	[34] [35] [36] [3]P [4] [7] [9] [12]P [4-] [5-] [6-] [7-]
* depending on kitchen doors may have different measurements: 713/271-PN - [22] 713/272-N - [25] 713/276-N (-PN) - [11] [14] [15] [16] [34] [35] [36] 713/277-N - [5-] [7-] 713/278-N - [4-] [6-] 713/280-N (-PN) - [4] [7] [12]P 713/284-N - [9] [3]P * package contains door set for corner cabinet GNW-60/72-P/P						
GNW-60/95-L/L		packages	carcass dimensions	carcass colours	available in	comments
	carcass	GNW-60/72	width 600 mm	BU WISP	<i>Royal</i>	[11] [22] [25] [14] [15] [16]
	doors	943/280-N* (-LN*)	depth 600 mm depth of side 300 mm height 946 mm	DW KA KAS OLS WIEL WISE	CAPITAL <i>Sentima</i> TRAFFIC	[34] [35] [36] [3]P [4] [7] [9] [12]P [4-] [5-] [6-] [7-]
* depending on kitchen doors may have different measurements: 943/271-LN - [22] 943/272-N - [25] 943/276-N (-LN) - [11] [14] [15] [16] [34] [35] [36] 943/277-N - [5-] [7-] 943/278-N - [4-] [6-] 943/280-N (-LN) - [4] [7] [12]P 943/284-N - [9] [3]P * package contains door set for corner cabinet GNW-60/72-L/L						
GNW-60/95-P/P		packages	carcass dimensions	carcass colours	available in	comments
	carcass	GNW-60/72	width 600 mm	BU WISP	<i>Royal</i>	[11] [22] [25] [14] [15] [16]
	doors	943/280-N* (-PN*)	depth 600 mm depth of side 300 mm height 946 mm	DW KA KAS OLS WIEL WISE	CAPITAL <i>Sentima</i> TRAFFIC	[34] [35] [36] [3]P [4] [7] [9] [12]P [4-] [5-] [6-] [7-]
* depending on kitchen doors may have different measurements: 943/271-PN - [22] 943/272-N - [25] 943/276-N (-PN) - [11] [14] [15] [16] [34] [35] [36] 943/277-N - [5-] [7-] 943/278-N - [4-] [6-] 943/280-N (-PN) - [4] [7] [12]P 943/284-N - [9] [3]P * package contains door set for corner cabinet GNW-60/72-P/P						
GNWU-60/72-L		packages	carcass dimensions	carcass colours	available in	comments
	carcass	GNWU-60/72	width 600 mm	BI KLN	<i>Royal</i>	[11] [22] [25] [14] [15] [16]
	door	713/396 (-L)	depth 600 mm depth of side 300 mm height 716 mm	BE OLS BU WE DMI WIEL DW WISE KA WISP KAS SZ	CAPITAL <i>Sentima</i> TRAFFIC <i>Classic</i> Modern BRW	[34] [35] [36] [3]P [4] [7] [9] [12]P [4-] [5-] [6-] [7-] <i>Dekorado Ledo Melos Rosa</i> Diona Hedar Telesto <i>FAL KAR POR EKR TAF_MDF</i>
GNWU-60/72-LV		packages	carcass dimensions	carcass colours	available in	comments
	carcass	GNWU-60/72	width 600 mm	BI KLN	<i>Royal</i>	[11] [22] [25] [14] [15] [16]
	door	713/396-V (-LV)	depth 600 mm	BE OLS	CAPITAL	[34] [35]
glazing	713/396-V*	depth of side 300 mm height 716 mm	BU WE DMI WIEL DW WISE KA WISP KAS SZ	<i>Sentima</i> TRAFFIC <i>Classic</i> Modern BRW	[3]P [4] [7] [9] [12]P [5-] [6-] [7-] <i>Dekorado Ledo Melos Rosa</i> Telesto <i>FAL KAR POR EKR TAF_MDF</i>	
* concerns doors, in which glazing is not factory fitted						
GNWU-60/72-LH		packages	carcass dimensions	carcass colours	available in	comments
	carcass	GNWU-60/72	width 600 mm	BI KLN	<i>Royal</i>	[11] [22] [25] [15] [16]
	door	713/396-V (-LH)	depth 600 mm depth of side 300 mm height 716 mm	BE OLS BU WE DMI WIEL DW WISE KA WISP KAS SZ		
GNWU-60/72-P		packages	carcass dimensions	carcass colours	available in	comments
	carcass	GNWU-60/72	width 600 mm	BI KLN	<i>Royal</i>	[11] [22] [25] [14] [15] [16]
	door	713/396 (-P)	depth 600 mm depth of side 300 mm height 716 mm	BE OLS BU WE DMI WIEL DW WISE KA WISP KAS SZ	CAPITAL <i>Sentima</i> TRAFFIC <i>Classic</i> Modern BRW	[34] [35] [36] [3]P [4] [7] [9] [12]P [4-] [5-] [6-] [7-] <i>Dekorado Ledo Melos Rosa</i> Diona Hedar Telesto <i>FAL KAR POR EKR TAF_MDF</i>

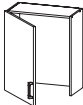

GNWU-60/72-PV	packages	carcass dimensions	carcass colours	appear in	comments	
	<p>carcass GNWU-60/72</p> <p>door 713/396-V (-PV)</p> <p>glazing 713/396-V*</p>	<p>width 600 mm</p> <p>depth 600 mm</p> <p>depth of side 300 mm</p> <p>height 716 mm</p>	<p>BI KLN</p> <p>BE OLS</p> <p>BU WE</p> <p>DMI WIEL</p> <p>DW WISE</p> <p>KA WISP</p> <p>KAS SZ</p>	<p>Royal</p> <p>CAPITAL</p> <p>Sentima</p> <p>TRAFFIC</p> <p>Classic</p> <p>Modern</p> <p>BRW</p>	<p>[11] [22] [25] [14] [15] [16]</p> <p>[34] [35]</p> <p>[3]P [4] [7] [9] [12]P</p> <p>[5-] [6-] [7-]</p> <p>Dekorado Ledo Melos Rosa</p> <p>Telesto</p> <p>FAL KAR POR EKR TAF_MDF</p>	<p>* concerns doors, in which glazing is not factory fitted</p>
GNWU-60/72-PH	packages	carcass dimensions	carcass colours	appear in	comments	
	<p>carcass GNWU-60/72</p> <p>door 713/396-V (-PH)</p>	<p>width 600 mm</p> <p>depth 600 mm</p> <p>depth of side 300 mm</p> <p>height 716 mm</p>	<p>BI KLN</p> <p>BE OLS</p> <p>BU WE</p> <p>DMI WIEL</p> <p>DW WISE</p> <p>KA WISP</p> <p>KAS SZ</p>	<p>Royal</p>	<p>[11] [22] [25] [15] [16]</p>	
GNWU-60/95-L	packages	carcass dimensions	carcass colours	appear in	comments	
	<p>carcass GNWU-60/95</p> <p>door 943/396 (-L)</p>	<p>width 600 mm</p> <p>depth 600 mm</p> <p>depth of side 300 mm</p> <p>height 946 mm</p>	<p>BI KLN</p> <p>BE OLS</p> <p>BU WE</p> <p>DMI WIEL</p> <p>DW WISE</p> <p>KA WISP</p> <p>KAS SZ</p>	<p>Royal</p> <p>CAPITAL</p> <p>Sentima</p> <p>TRAFFIC</p> <p>Classic</p> <p>Modern</p> <p>BRW</p>	<p>[11] [22] [25] [14] [15] [16]</p> <p>[34] [35] [36]</p> <p>[3]P [4] [7] [9] [12]P</p> <p>[4-] [5-] [6-] [7-]</p> <p>Dekorado Ledo Melos Rosa</p> <p>Diona Hedar Telesto</p> <p>FAL KAR POR EKR TAF_MDF</p>	
GNWU-60/95-LV	packages	carcass dimensions	carcass colours	appear in	comments	
	<p>carcass GNWU-60/95</p> <p>door 943/396-V (-LV)</p> <p>glazing 943/396-V*</p>	<p>width 600 mm</p> <p>depth 600 mm</p> <p>depth of side 300 mm</p> <p>height 946 mm</p>	<p>BI KLN</p> <p>BE OLS</p> <p>BU WE</p> <p>DMI WIEL</p> <p>DW WISE</p> <p>KA WISP</p> <p>KAS SZ</p>	<p>Royal</p> <p>CAPITAL</p> <p>Sentima</p> <p>TRAFFIC</p> <p>Classic</p> <p>Modern</p> <p>BRW</p>	<p>[11] [22] [25] [14] [15] [16]</p> <p>[34] [35]</p> <p>[3]P [4] [7] [9] [12]P</p> <p>[5-] [6-] [7-]</p> <p>Dekorado Ledo Melos Rosa</p> <p>Telesto</p> <p>FAL KAR POR EKR TAF_MDF</p>	<p>* concerns doors, in which glazing is not factory fitted</p>
GNWU-60/95-LH	packages	carcass dimensions	carcass colours	appear in	comments	
	<p>carcass GNWU-60/95</p> <p>door 943/396-V (-LH)</p>	<p>width 600 mm</p> <p>depth 600 mm</p> <p>depth of side 300 mm</p> <p>height 946 mm</p>	<p>BI KLN</p> <p>BE OLS</p> <p>BU WE</p> <p>DMI WIEL</p> <p>DW WISE</p> <p>KA WISP</p> <p>KAS SZ</p>	<p>Royal</p>	<p>[11] [22] [25] [15] [16]</p>	
GNWU-60/95-P	packages	carcass dimensions	carcass colours	appear in	comments	
	<p>carcass GNWU-60/95</p> <p>door 943/396 (-P)</p>	<p>width 600 mm</p> <p>depth 600 mm</p> <p>depth of side 300 mm</p> <p>height 946 mm</p>	<p>BI KLN</p> <p>BE OLS</p> <p>BU WE</p> <p>DMI WIEL</p> <p>DW WISE</p> <p>KA WISP</p> <p>KAS SZ</p>	<p>Royal</p> <p>CAPITAL</p> <p>Sentima</p> <p>TRAFFIC</p> <p>Classic</p> <p>Modern</p> <p>BRW</p>	<p>[11] [22] [25] [14] [15] [16]</p> <p>[34] [35] [36]</p> <p>[3]P [4] [7] [9] [12]P</p> <p>[4-] [5-] [6-] [7-]</p> <p>Dekorado Ledo Melos Rosa</p> <p>Diona Hedar Telesto</p> <p>FAL KAR POR EKR TAF_MDF</p>	
GNWU-60/95-PV	packages	carcass dimensions	carcass colours	appear in	comments	
	<p>carcass GNWU-60/95</p> <p>door 943/396-V (-PV)</p> <p>glazing 943/396-V*</p>	<p>width 600 mm</p> <p>depth 600 mm</p> <p>depth of side 300 mm</p> <p>height 946 mm</p>	<p>BI KLN</p> <p>BE OLS</p> <p>BU WE</p> <p>DMI WIEL</p> <p>DW WISE</p> <p>KA WISP</p> <p>KAS SZ</p>	<p>Royal</p> <p>CAPITAL</p> <p>Sentima</p> <p>TRAFFIC</p> <p>Classic</p> <p>Modern</p> <p>BRW</p>	<p>[11] [22] [25] [14] [15] [16]</p> <p>[34] [35]</p> <p>[3]P [4] [7] [9] [12]P</p> <p>[5-] [6-] [7-]</p> <p>Dekorado Ledo Melos Rosa</p> <p>Telesto</p> <p>FAL KAR POR EKR TAF_MDF</p>	<p>* concerns doors, in which glazing is not factory fitted</p>
GNWU-60/95-PH	packages	carcass dimensions	carcass colours	appear in	comments	
	<p>carcass GNWU-60/95</p> <p>door 943/396-V (-PH)</p>	<p>width 600 mm</p> <p>depth 600 mm</p> <p>depth of side 300 mm</p> <p>height 946 mm</p>	<p>BI KLN</p> <p>BE OLS</p> <p>BU WE</p> <p>DMI WIEL</p> <p>DW WISE</p> <p>KA WISP</p> <p>KAS SZ</p>	<p>Royal</p>	<p>[11] [22] [25] [15] [16]</p>	

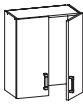

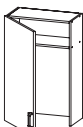
GNZ-30/72		packages	carcass dimensions		carcass colours		available in	comments
	carcass	GNZ-30/72	width	300 mm	BI	OLS	<i>Royal</i> [11]	cabinet may finish assembly from left or right side
			depth	300 mm	BE	WE	CAPITAL [34] [35] [36]	
			height	716 mm	BU	WIEL	<i>Sentima</i> [3]P [4] [7] [9] [12]P	
					DMI	WISE	TRAFFIC [4-] [5-] [6-] [7-]	
				DW	WISP	<i>Classic</i> Dekorado Ledo Melos Rosa		
				KAS	SZ	Modern Diona Hedar Telesto		
				KLN		BRW FAL KAR POR EKR TAF_MDF		
GNZ-30/95		packages	carcass dimensions		carcass colours		available in	comments
	carcass	GNZ-30/95	width	300 mm	BI	OLS	<i>Royal</i> [11]	cabinet may finish assembly from left or right side
			depth	300 mm	BE	WE	CAPITAL [34] [35] [36]	
			height	946 mm	BU	WIEL	<i>Sentima</i> [3]P [4] [7] [9] [12]P	
					DMI	WISE	TRAFFIC [4-] [5-] [6-] [7-]	
				DW	WISP	<i>Classic</i> Dekorado Ledo Melos Rosa		
				KAS	SZ	Modern Diona Hedar Telesto		
				KLN		BRW FAL KAR POR EKR TAF_MDF		
GNZUF-30/72-LV		packages	carcass dimensions		carcass colours		available in	comments
	carcass	GNZUF-30/72	width	308 mm	BI	WE	<i>Sentima</i> [3]P [4] [7] [9] [12]P	* concerns doors, in which glazing is not factory fitted
	door	713/430-V (-LV)	depth	286 mm	BE	WIEL	TRAFFIC [5-] [6-] [7-]	
	glazing	713/430-V*	height	716 mm	BU	WISE	<i>Classic</i> Dekorado Ledo Melos Rosa	
					DMI	WISP	Modern Telesto	
				DW	SZ	BRW FAL KAR POR EKR TAF_MDF		
				KLN	OLS			
GNZUF-30/72-PV		packages	carcass dimensions		carcass colours		available in	comments
	carcass	GNZUF-30/72	width	308 mm	BI	WE	<i>Sentima</i> [3]P [4] [7] [9] [12]P	* concerns doors, in which glazing is not factory fitted
	door	713/430-V (-PV)	depth	286 mm	BE	WIEL	TRAFFIC [5-] [6-] [7-]	
	glazing	713/430-V*	height	716 mm	BU	WISE	<i>Classic</i> Dekorado Ledo Melos Rosa	
					DMI	WISP	Modern Telesto	
				DW	SZ	BRW FAL KAR POR EKR TAF_MDF		
				KLN	OLS			
GNZUF-30/95-LV		packages	carcass dimensions		carcass colours		available in	comments
	carcass	GNZUF-30/95	width	308 mm	BI	WE	<i>Sentima</i> [3]P [4] [7] [9] [12]P	* concerns doors, in which glazing is not factory fitted
	door	943/430-V (-LV)	depth	286 mm	BE	WIEL	TRAFFIC [5-] [6-] [7-]	
	glazing	943/430-V*	height	946 mm	BU	WISE	<i>Classic</i> Dekorado Ledo Melos Rosa	
					DMI	WISP	Modern Telesto	
				DW	SZ	BRW FAL KAR POR EKR TAF_MDF		
				KLN	OLS			
GNZUF-30/95-PV		packages	carcass dimensions		carcass colours		available in	comments
	carcass	GNZUF-30/95	width	308 mm	BI	WE	<i>Sentima</i> [3]P [4] [7] [9] [12]P	* concerns doors, in which glazing is not factory fitted
	door	943/430-V (-PV)	depth	286 mm	BE	WIEL	TRAFFIC [5-] [6-] [7-]	
	glazing	943/430-V*	height	946 mm	BU	WISE	<i>Classic</i> Dekorado Ledo Melos Rosa	
					DMI	WISP	Modern Telesto	
				DW	SZ	BRW FAL KAR POR EKR TAF_MDF		
				KLN	OLS			
GNZU2F-30/72-LUV		packages	carcass dimensions		carcass colours		available in	comments
	carcass	GNZU2F-30/72	width	300 mm	KAS		<i>Royal</i> [11]	
	door	713/466-UV (-LUV)	depth	300 mm	WISE		CAPITAL [34] [35]	
			height	716 mm	WISP			
GNZU2F-30/72-LUH		packages	carcass dimensions		carcass colours		appear in	comments
	carcass	GNZU2F-30/72	width	300 mm	KAS		<i>Royal</i> [11]	
	door	713/466-UH	depth	300 mm	WISE			
			height	716 mm	WISP			



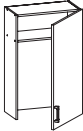
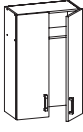

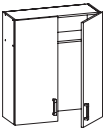
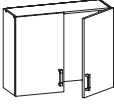
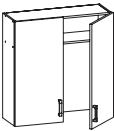





GNZU2F-30/72-PUV		packages	carcass dimensions		carcass colours	available in	comments
	carcass	GNZU2F-30/72	width	300 mm	KAS	<i>Royal</i> CAPITAL	[11] [34] [35]
	door	713/466-UV (-PUV)	depth	300 mm	WISE		
			height	716 mm	WISP		
GNZU2F-30/72-PUH		packages	carcass dimensions		carcass colours	available in	comments
	carcass	GNZU2F-30/72	width	300 mm	KAS	<i>Royal</i>	[11]
	door	713/466-UH	depth	300 mm	WISE		
			height	716 mm	WISP		
GNZU2F-30/95-LUV		packages	carcass dimensions		carcass colours	available in	comments
	carcass	GNZU2F-30/95	width	300 mm	KAS	<i>Royal</i> CAPITAL	[11] [34] [35]
	door	943/466-UV (-LUV)	depth	300 mm	WISE		
			height	946 mm	WISP		
GNZU2F-30/95-LUH		packages	carcass dimensions		carcass colours	available in	comments
	carcass	GNZU2F-30/95	width	300 mm	KAS	<i>Royal</i>	[11]
	door	943/466-UH	depth	300 mm	WISE		
			height	946 mm	WISP		
GNZU2F-30/95-PUV		packages	carcass dimensions		carcass colours	available in	comments
	carcass	GNZU2F-30/95	width	300 mm	KAS	<i>Royal</i> CAPITAL	[11] [34] [35]
	door	943/466-UV (-PUV)	depth	300 mm	WISE		
			height	946 mm	WISP		
GNZU2F-30/95-PUH		packages	carcass dimensions		carcass colours	available in	comments
	carcass	GNZU2F-30/95	width	300 mm	KAS	<i>Royal</i>	[11]
	door	943/466-UH	depth	300 mm	WISE		
			height	946 mm	WISP		
GNZR-30/72		packages	carcass dimensions		carcass colours	available in	comments
	carcass	GNZR-30/72	width	300 mm	DW	<i>Royal</i>	[22] [25] [14] [15] [16]
			depth	300 mm	KA		
			height	716 mm	KAS		cabinet may finish assembly from left or right side
					OLS		
					WISP		
GNZR-30/95		packages	carcass dimensions		carcass colours	available in	comments
	carcass	GNZR-30/95	width	300 mm	DW	<i>Royal</i>	[22] [25] [14] [15] [16]
			depth	300 mm	KA		
			height	946 mm	KAS		cabinet may finish assembly from left or right side
					OLS		
					WISP		



GNZRF-30/72-LRV		packages	carcass dimensions		carcass colours	available in	comments
	carcass	GNZRF-30/72	width	300 mm	DW	[22] [25] [14] [15] [16]	
	door	713/300-LRV	depth	300 mm	KA		
			height	716 mm	KAS OLS WISP		
GNZRF-30/72-PRV		packages	carcass dimensions		carcass colours	available in	comments
	carcass	GNZRF-30/72	width	300 mm	DW	[22] [25] [14] [15] [16]	
	door	713/300-PRV	depth	300 mm	KA		
			height	716 mm	KAS OLS WISP		
GNZRF-30/95-LRV		packages	carcass dimensions		carcass colours	available in	comments
	carcass	GNZRF-30/95	width	300 mm	DW	[22] [25] [14] [15] [16]	
	door	943/300-LRV	depth	300 mm	KA		
			height	946 mm	KAS OLS WISP		
GNZRF-30/95-PRV		packages	carcass dimensions		carcass colours	available in	comments
	carcass	GNZRF-30/95	width	300 mm	DW	[22] [25] [14] [15] [16]	
	door	943/300-PRV	depth	300 mm	KA		
			height	946 mm	KAS OLS WISP		





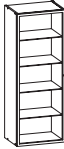
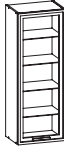
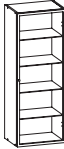
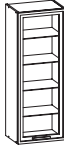
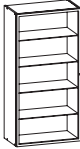
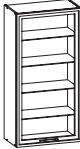
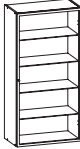

GC-45/72-L		packages	carcass dimensions		carcass colours		available in	comments	
	carcass	GC-45/72	width	450 mm	BI	KLN	<i>Royal</i> CAPITAL <i>Sentima</i> TRAFFIC <i>Classic</i> Modern 	[11] [22] [25] [14] [15] [16] [34] [35] [36] [3]P [4] [7] [9] [12]P [4-] [5-] [6-] [7-] Dekorado Ledo Melos Rosa Diona Hedar Telesto FAL KAR POR EKR TAF_MDF	drainer is ordered separately
	door	713/446 (-L)	depth	300 mm	BE	OLS			
			height	716 mm	BU	WE			
					DMI	WIEL			
					DW	WISE			
					KA	WISP			
					KAS	SZ			
GC-45/72-P		packages	carcass dimensions		carcass colours		available in	comments	
	carcass	GC-45/72	width	450 mm	BI	KLN	<i>Royal</i> CAPITAL <i>Sentima</i> TRAFFIC <i>Classic</i> Modern 	[11] [22] [25] [14] [15] [16] [34] [35] [36] [3]P [4] [7] [9] [12]P [4-] [5-] [6-] [7-] Dekorado Ledo Melos Rosa Diona Hedar Telesto FAL KAR POR EKR TAF_MDF	drainer is ordered separately
	door	713/446 (-P)	depth	300 mm	BE	OLS			
			height	716 mm	BU	WE			
					DMI	WIEL			
					DW	WISE			
					KA	WISP			
					KAS	SZ			
GC-45/95-L		packages	carcass dimensions		carcass colours		available in	comments	
	carcass	GC-45/95	width	450 mm	BU	WISP	<i>Royal</i> CAPITAL <i>Sentima</i> TRAFFIC	[11] [22] [25] [14] [15] [16] [34] [35] [36] [3]P [4] [7] [9] [12]P [4-] [5-] [6-] [7-]	drainer is ordered separately
	door	943/446 (-L)	depth	300 mm	DW				
			height	946 mm	KA				
					KAS				
					OLS				
					WIEL				
					WISE				
GC-45/95-P		packages	carcass dimensions		carcass colours		available in	comments	
	carcass	GC-45/95	width	450 mm	BU	WISP	<i>Royal</i> CAPITAL <i>Sentima</i> TRAFFIC	[11] [22] [25] [14] [15] [16] [34] [35] [36] [3]P [4] [7] [9] [12]P [4-] [5-] [6-] [7-]	drainer is ordered separately
	door	943/446 (-P)	depth	300 mm	DW				
			height	946 mm	KA				
					KAS				
					OLS				
					WIEL				
					WISE				
GC-60/72-L		packages	carcass dimensions		carcass colours		available in	comments	
	carcass	GC-60/72	width	600 mm	BI	KLN	<i>Royal</i> CAPITAL <i>Sentima</i> TRAFFIC <i>Classic</i> Modern 	[11] [22] [25] [14] [15] [16] [34] [35] [36] [3]P [4] [7] [9] [12]P [4-] [5-] [6-] [7-] Dekorado Ledo Melos Rosa Diona Hedar Telesto FAL KAR POR EKR TAF_MDF	drainer is ordered separately
	door	713/596 (-L)	depth	300 mm	BE	OLS			
			height	716 mm	BU	WE			
					DMI	WIEL			
					DW	WISE			
					KA	WISP			
					KAS	SZ			
GC-60/72-P		packages	carcass dimensions		carcass colours		available in	comments	
	carcass	GC-60/72	width	600 mm	BI	KLN	<i>Royal</i> CAPITAL <i>Sentima</i> TRAFFIC <i>Classic</i> Modern 	[11] [22] [25] [14] [15] [16] [34] [35] [36] [3]P [4] [7] [9] [12]P [4-] [5-] [6-] [7-] Dekorado Ledo Melos Rosa Diona Hedar Telesto FAL KAR POR EKR TAF_MDF	drainer is ordered separately
	door	713/596 (-P)	depth	300 mm	BE	OLS			
			height	716 mm	BU	WE			
					DMI	WIEL			
					DW	WISE			
					KA	WISP			
					KAS	SZ			
GC-60/72-L/P		packages	carcass dimensions		carcass colours		available in	comments	
	carcass	GC-60/72	width	600 mm	BI	KLN	<i>Royal</i> CAPITAL <i>Sentima</i> TRAFFIC <i>Classic</i> Modern 	[11] [22] [25] [14] [15] [16] [34] [35] [36] [3]P [4] [7] [9] [12]P [4-] [5-] [6-] [7-] Dekorado Ledo Melos Rosa Diona Hedar Telesto FAL KAR POR EKR TAF_MDF	drainer is ordered separately
	doors	713/296 (-L) 713/296 (-P)	depth	300 mm	BE	OLS			
			height	716 mm	BU	WE			
					DMI	WIEL			
					DW	WISE			
					KA	WISP			
					KAS	SZ			
GC-60/95-L		packages	carcass dimensions		carcass colours		available in	comments	
	carcass	GC-60/95	width	600 mm	BI	KLN	<i>Royal</i> CAPITAL <i>Sentima</i> TRAFFIC <i>Classic</i> Modern 	[11] [22] [25] [14] [15] [16] [34] [35] [36] [3]P [4] [7] [9] [12]P [4-] [5-] [6-] [7-] Dekorado Ledo Melos Rosa Diona Hedar Telesto FAL KAR POR EKR TAF_MDF	drainer is ordered separately
	door	943/596 (-L)	depth	300 mm	BE	OLS			
			height	946 mm	BU	WE			
					DMI	WIEL			
					DW	WISE			
					KA	WISP			
					KAS	SZ			



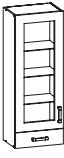
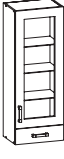

GC-60/95-P		packages	carcass dimensions		carcass colours		available in	comments	
	carcass	GC-60/95	width	600 mm	BU	WISP	<i>Royal</i> CAPITAL <i>Sentima</i> TRAFFIC	[11] [22] [25] [14] [15] [16] [34] [35] [36] [3]P [4] [7] [9] [12]P [4-] [5-] [6-] [7-]	drainer is ordered separately
	door	943/596 (-P)	depth	300 mm	DW				
			height	946 mm	KA				
					KAS				
					OLS				
					WIEL				
					WISE				
GC-60/95-L/P		packages	carcass dimensions		carcass colours		available in	comments	
	carcass	GC-60/95	width	600 mm	BU	WISP	<i>Royal</i> CAPITAL <i>Sentima</i> TRAFFIC	[11] [22] [25] [14] [15] [16] [34] [35] [36] [3]P [4] [7] [9] [12]P [4-] [5-] [6-] [7-]	drainer is ordered separately
	doors	943/296 (-L) 943/296 (-P)	depth	300 mm	DW				
			height	946 mm	KA				
					KAS				
					OLS				
					WIEL				
					WISE				
GC-80/72-L/P		packages	carcass dimensions		carcass colours		available in	comments	
	carcass	GC-80/72	width	800 mm	BI	WE	<i>Sentima</i> TRAFFIC	[3]P [4] [7] [9] [12]P [4-] [5-] [6-] [7-]	drainer is ordered separately
	doors	713/396 (-L) 713/396 (-P)	depth	300 mm	BE	WIEL			
			height	716 mm	BU	WISE	<i>Classic</i>	Dekorado Ledo Melos Rosa	
					DMI	WISP	Modern	Diona Hedar Telesto	
					DW	SZ		FAL KAR POR EKR TAF_MDF	
					KLN				
					OLS				
GC-80/95-L/P		packages	carcass dimensions		carcass colours		available in	comments	
	carcass	GC-80/95	width	800 mm	BU		<i>Sentima</i> TRAFFIC	[3]P [4] [7] [9] [12]P [4-] [5-] [6-] [7-]	drainer is ordered separately
	doors	943/396 (-L) 943/396 (-P)	depth	300 mm	DW				
			height	946 mm	OLS				
					WIEL				
GC-90/72-L/P		packages	carcass dimensions		carcass colours		available in	comments	
	carcass	GC-90/72	width	900 mm	BU	WISP	<i>Royal</i> CAPITAL <i>Sentima</i> TRAFFIC	[11] [22] [25] [14] [15] [16] [34] [35] [36] [3]P [4] [7] [9] [12]P [4-] [5-] [6-] [7-]	drainer is ordered separately
	doors	713/446 (-L) 713/446 (-P)	depth	300 mm	DW				
			height	716 mm	KA				
					KAS				
					OLS				
					WIEL				
					WISE				
GC-90/95-L/P		packages	carcass dimensions		carcass colours		available in	comments	
	carcass	GC-90/95	width	900 mm	BU	WISP	<i>Royal</i> CAPITAL <i>Sentima</i> TRAFFIC	[11] [22] [25] [14] [15] [16] [34] [35] [36] [3]P [4] [7] [9] [12]P [4-] [5-] [6-] [7-]	drainer is ordered separately
	doors	943/446 (-L) 943/446 (-P)	depth	300 mm	DW				
			height	946 mm	KA				
					KAS				
					OLS				
					WIEL				
					WISE				

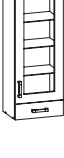



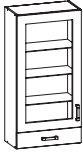
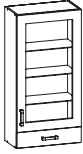

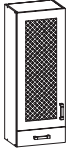
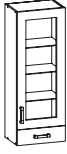
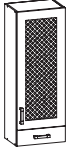
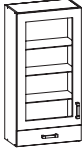
GP35-60/43		packages	carcass dimensions		carcass colours		available in	comments
	carcass	GP35-60/43	width	600 mm	BI	KLN	<i>Royal</i>	cabinet with free standing kitchen microwave, internal dimensions shown in catalogue System in a Nutshell on p. 57
			depth	450 mm	BE	OLS	CAPITAL	
			depth of side	300 mm	BU	WE	<i>Sentima</i>	
			height	429 mm	DMI	WIEL	TRAFFIC	
					DW	WISE	<i>Classic</i>	
				KA	WISP	Modern	<i>Dekorado Ledo Melos Rosa</i>	
				KAS	SZ	BRW	Diona Hedar Telesto	
							<i>FAL KAR POR EKR TAF_MDF</i>	
GOO-60/50-O		packages	carcass dimensions		carcass colours		available in	comments
	carcass	GOO-60/50	width	600 mm	BI	WE	<i>Royal</i>	cabinet for housing telescopic hood (SLIM), internal dimensions shown in catalogue System in a Nutshell on p. 57
	door	500/596-O	depth	300 mm	BE	WIEL	CAPITAL	
			height	503 mm	BU	WISE	<i>Sentima</i>	
					DMI	WISP	TRAFFIC	
					DW	SZ	<i>Classic</i>	
				KLN		Modern	<i>Dekorado Ledo Melos Rosa</i>	
				OLS		BRW	Diona Hedar Telesto	
							<i>FAL KAR POR EKR TAF_MDF</i>	

GI-5/72-B		packages	carcass dimensions		carcass colours		available in	comments
	carcass	GI-5/72	width	50 mm	BI	WE	<i>Royal</i>	[14] [15]
	door	713/50-I	depth	300 mm	BE	WIEL	<i>Sentima</i>	[3]P [4] [7] [9] [12]P
			height	716 mm	BU	WISE	<i>Classic</i>	<i>Dekorado Ledo Rosa</i>
					DMI	WISP		FAL KAR POR
					DW	SZ		
					KLN			
					OLS			
GI-5/95-B		packages	carcass dimensions		carcass colours		available in	comments
	carcass	GI-5/95	width	50 mm	BI	WE	<i>Royal</i>	[14] [15]
	door	943/50-I	depth	300 mm	BE	WIEL	<i>Sentima</i>	[3]P [4] [7] [9] [12]P
			height	716 mm	BU	WISE	<i>Classic</i>	<i>Dekorado Ledo Rosa</i>
					DMI	WISP		FAL KAR POR
					DW	SZ		
					KLN			
					OLS			
GS-30/14-2S		packages	carcass dimensions		carcass colours		available in	comments
5 	carcass	GS-30/14	width	300 mm	BI	WE	<i>Royal</i>	[14] [15] [16]
	doors	140/146-S x2	depth	300 mm	BE	WIEL	<i>Sentima</i>	[3]P [4] [7] [9] [12]P
			height	143 mm	BU	WISE	<i>Classic</i>	<i>Dekorado Ledo Melos Rosa</i>
					DMI	WISP		FAL KAR POR
					DW	SZ		
					KLN			
					OLS			
GS-45/14-3S		packages	carcass dimensions		carcass colours		available in	comments
5 	carcass	GS-45/14	width	450 mm	BI	WE	<i>Royal</i>	[14] [15] [16]
	doors	140/146-S x3	depth	300 mm	BE	WIEL	<i>Sentima</i>	[3]P [4] [7] [9] [12]P
			height	143 mm	BU	WISE	<i>Classic</i>	<i>Dekorado Ledo Melos Rosa</i>
					DMI	WISP		FAL KAR POR
					DW	SZ		
					KLN			
					OLS			
GS-30/15-2S		packages	carcass dimensions		carcass colours		available in	comments
4 	carcass	GS-30/15	width	300 mm	KA		<i>Royal</i>	[11] [22] [25]
	doors	146/146-S x2	depth	300 mm	KAS			
			height	150 mm				
GS-45/15-3S		packages	carcass dimensions		carcass colours		available in	comments
4 	carcass	GS-45/15	width	450 mm	KA		<i>Royal</i>	[11] [22] [25]
	doors	146/146-S x3	depth	300 mm	KAS			
			height	150 mm				
KORONA-150/14		packages	carcass dimensions		carcass colours		available in	comments
5 	carcass	—	width	—	—		<i>Royal</i>	[11] [22] [25] [14] [15] [16]
	door	1500/140-K	depth	—			<i>Sentima</i>	[4] [7] [12]P
			height	—				

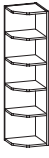
T-45/121-LVA		packages	carcass dimensions		carcass colours	available in	comments
	carcass	T-45/121	width	450 mm	BU	CAPITAL TRAFFIC Modern BRW	[34] [35] [36] [4-] [5-] [7-] Diona Hedar Telesto EKR TAF_MDF
	door	1198/446-VA	depth	300 mm	DW		
			height	1208 mm	OLS WIEL WISE WISP		
T-45/121-LVA3		packages	carcass dimensions		carcass colours	available in	comments
	carcass	T-45/121	width	450 mm	BU	CAPITAL TRAFFIC Modern BRW	[34] [35] [36] [4-] [5-] [7-] Diona Hedar Telesto EKR TAF_MDF
	door	1198/446-LVA3	depth	300 mm	DW		
			height	1208 mm	OLS WIEL WISE WISP		
T-45/121-PVA		packages	carcass dimensions		carcass colours	available in	comments
	carcass	T-45/121	width	450 mm	BU	CAPITAL TRAFFIC Modern BRW	[34] [35] [36] [4-] [5-] [7-] Diona Hedar Telesto EKR TAF_MDF
	door	1198/446-VA	depth	300 mm	DW		
			height	1208 mm	OLS WIEL WISE WISP		
T-45/121-PVA3		packages	carcass dimensions		carcass colours	available in	comments
	carcass	T-45/121	width	450 mm	BU	CAPITAL TRAFFIC Modern BRW	[34] [35] [36] [4-] [5-] [7-] Diona Hedar Telesto EKR TAF_MDF
	door	1198/446-PVA3	depth	300 mm	DW		
			height	1208 mm	OLS WIEL WISE WISP		
T-60/121-LVA		packages	carcass dimensions		carcass colours	available in	comments
	carcass	T-60/121	width	600 mm	BU	CAPITAL TRAFFIC Modern BRW	[34] [35] [36] [4-] [5-] [7-] Diona Hedar Telesto EKR TAF_MDF
	door	1198/596-VA	depth	300 mm	DW		
			height	1208 mm	OLS WIEL WISE WISP		
T-60/121-LVA3		packages	carcass dimensions		carcass colours	available in	comments
	carcass	T-60/121	width	600 mm	BU	CAPITAL TRAFFIC Modern BRW	[34] [35] [36] [4-] [5-] [7-] Diona Hedar Telesto EKR TAF_MDF
	door	1198/596-LVA3	depth	300 mm	DW		
			height	1208 mm	OLS WIEL WISE WISP		
T-60/121-PVA		packages	carcass dimensions		carcass colours	available in	comments
	carcass	T-60/121	width	600 mm	BU	CAPITAL TRAFFIC Modern BRW	[34] [35] [36] [4-] [5-] [7-] Diona Hedar Telesto EKR TAF_MDF
	door	1198/596-VA	depth	300 mm	DW		
			height	1208 mm	OLS WIEL WISE WISP		
T-60/121-PVA3		packages	carcass dimensions		carcass colours	available in	comments
	carcass	T-60/121	width	600 mm	BU	CAPITAL TRAFFIC Modern BRW	[34] [35] [36] [4-] [5-] [7-] Diona Hedar Telesto EKR TAF_MDF
	door	1198/596-PVA3	depth	300 mm	DW		
			height	1208 mm	OLS WIEL WISE WISP		

TSM/5-45/121-S/LV		packages	carcass dimensions		carcass colours	available in	comments		
5		carcass	TSMST/5-45/121	width	450 mm	BU DW OLS WIEL WISE WISP	<i>Sentima</i> TRAFFIC	[3]P [4] [7] [9] [12]P [5-] [6-] [7-]	drawer on METABOX® blum rails * concerns doors, in which glazing is not factory fitted
		doors	1055/446-V (-LV) 140/446-SM	depth	300 mm				
		drawer	SM-320M2700 SM-140/446/270	height	1208 mm				
		glazing	1055/446-V*						
TSM/5-45/121-S/PV		packages	carcass dimensions		carcass colours	available in	comments		
5		carcass	TSMST/5-45/121	width	450 mm	BU DW OLS WIEL WISE WISP	<i>Sentima</i> TRAFFIC	[3]P [4] [7] [9] [12]P [5-] [6-] [7-]	drawer on METABOX® blum rails * concerns doors, in which glazing is not factory fitted
		doors	1055/446-V (-PV) 140/446-SM	depth	300 mm				
		drawer	SM-320M2700 SM-140/446/270	height	1208 mm				
		glazing	1055/446-V*						
TSM/5-60/121-S/LV		packages	carcass dimensions		carcass colours	available in	comments		
5		carcass	TSMST/5-60/121	width	600 mm	BU DW OLS WIEL WISE WISP	<i>Sentima</i> TRAFFIC	[3]P [4] [7] [9] [12]P [5-] [6-] [7-]	drawer on METABOX® blum rails * concerns doors, in which glazing is not factory fitted
		doors	1055/596-V (-LV) 140/596-SM	depth	300 mm				
		drawer	SM-320M2700 SM-140/596/270	height	1208 mm				
		glazing	1055/596-V*						
TSM/5-60/121-S/PV		packages	carcass dimensions		carcass colours	available in	comments		
5		carcass	TSMST/5-60/121	width	600 mm	BU DW OLS WIEL WISE WISP	<i>Sentima</i> TRAFFIC	[3]P [4] [7] [9] [12]P [5-] [6-] [7-]	drawer on METABOX® blum rails * concerns doors, in which glazing is not factory fitted
		doors	1055/596-V (-PV) 140/596-SM	depth	300 mm				
		drawer	SM-320M2700 SM-140/596/270	height	1208 mm				
		glazing	1055/596-V*						
TST/4-45/121-S/LV		packages	carcass dimensions		carcass colours	available in	comments		
4		carcass	TST/4-45/121	width	450 mm	KA KAS	<i>Royal</i>	[11] [22] [25]	TANDEMBOX® drawers with guides and BLUMOTION® blum shock absorber system
		doors	1019/446-LV 176/446-ST	depth	300 mm				
		drawer	TS-45-N-KOR	height	1208 mm				
TST/4-45/121-S/LH		packages	carcass dimensions		carcass colours	available in	comments		
4		carcass	TST/4-45/121	width	450 mm	KA KAS	<i>Royal</i>	[11] [22] [25]	TANDEMBOX® drawers with guides and BLUMOTION® blum shock absorber system
		doors	1019/446-H (-LH) 176/446-ST	depth	300 mm				
		drawer	TS-45-N-KOR	height	1208 mm				
TST/4-45/121-S/PV		packages	carcass dimensions		carcass colours	available in	comments		
4		carcass	TST/4-45/121	width	450 mm	KA KAS	<i>Royal</i>	[11] [22] [25]	TANDEMBOX® drawers with guides and BLUMOTION® blum shock absorber system
		doors	1019/446-PV 176/446-ST	depth	300 mm				
		drawer	TS-45-N-KOR	height	1208 mm				
TST/4-45/121-S/PH		packages	carcass dimensions		carcass colours	available in	comments		
4		carcass	TST/4-45/121	width	450 mm	KA KAS	<i>Royal</i>	[11] [22] [25]	TANDEMBOX® drawers with guides and BLUMOTION® blum shock absorber system
		doors	1019/446-H (-PH) 176/446-ST	depth	300 mm				
		drawer	TS-45-N-KOR	height	1208 mm				

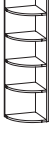
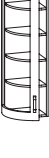
TST/4-60/121-S/LV		packages	carcass dimensions		carcass colours	available in	comments	
4		carcass	TST/4-60/121	width	600 mm	KA	<i>Royal</i> [11] [22] [25]	TANDEMBOX® drawers with guides and BLUMOTION® blum shock absorber system
		doors	1019/596-LV 176/596-ST	depth	300 mm	KAS		
		drawer	TS-60-N-KOR	height	1208 mm			
TST/4-60/121-S/PV		packages	carcass dimensions		carcass colours	available in	comments	
4		carcass	TST/4-60/121	width	600 mm	KA	<i>Royal</i> [11] [22] [25]	TANDEMBOX® drawers with guides and BLUMOTION® blum shock absorber system
		doors	1019/596-PV 176/596-ST	depth	300 mm	KAS		
		drawer	TS-60-N-KOR	height	1208 mm			
TST/5-45/121-S/LV		packages	carcass dimensions		carcass colours	available in	comments	
5		carcass	TSMST/5-45/121	width	450 mm	BU	<i>Royal</i> CAPITAL [14] [15] [16]	TANDEMBOX® drawers with guides and BLUMOTION® blum shock absorber system
		doors	1055/446-V (-LV) 140/446-ST	depth	300 mm	DW		
		drawer	TS-45-N-KOR	height	1208 mm	OLS WIEL WISE WISP		
TST/5-45/121-S/LH		packages	carcass dimensions		carcass colours	available in	comments	
5		carcass	TSMST/5-45/121	width	450 mm	BU	<i>Royal</i> [15] [16]	TANDEMBOX® drawers with guides and BLUMOTION® blum shock absorber system
		doors	1055/446-LH 140/446-ST	depth	300 mm	DW		
		drawer	TS-45-N-KOR	height	1208 mm	OLS WIEL WISE WISP		
TST/5-45/121-S/PV		packages	carcass dimensions		carcass colours	available in	comments	
5		carcass	TSMST/5-45/121	width	450 mm	BU	<i>Royal</i> CAPITAL [14] [15] [16]	TANDEMBOX® drawers with guides and BLUMOTION® blum shock absorber system
		doors	1055/446-V (-PV) 140/446-ST	depth	300 mm	DW		
		drawer	TS-45-N-KOR	height	1208 mm	OLS WIEL WISE WISP		
TST/5-45/121-S/PH		packages	carcass dimensions		carcass colours	available in	comments	
5		carcass	TSMST/5-45/121	width	450 mm	BU	<i>Royal</i> [15] [16]	TANDEMBOX® drawers with guides and BLUMOTION® blum shock absorber system
		doors	1055/446-PH 140/446-ST	depth	300 mm	DW		
		drawer	TS-45-N-KOR	height	1208 mm	OLS WIEL WISE WISP		
TST/5-60/121-S/LV		packages	carcass dimensions		carcass colours	available in	comments	
5		carcass	TSMST/5-60/121	width	600 mm	BU	<i>Royal</i> CAPITAL [14] [15] [16]	TANDEMBOX® drawers with guides and BLUMOTION® blum shock absorber system
		doors	1055/596-V (-LV) 140/596-ST	depth	300 mm	DW		
		drawer	TS-60-N-KOR	height	1208 mm	OLS WIEL WISE WISP		
TST/5-60/121-S/PV		packages	carcass dimensions		carcass colours	available in	comments	
5		carcass	TSMST/5-60/121	width	600 mm	BU	<i>Royal</i> CAPITAL [14] [15] [16]	TANDEMBOX® drawers with guides and BLUMOTION® blum shock absorber system
		doors	1055/596-V (-PV) 140/596-ST	depth	300 mm	DW		
		drawer	TS-60-N-KOR	height	1208 mm	OLS WIEL WISE WISP		

TNZ-30/121		packages	carcass dimensions		carcass colours	available in	comments
	carcass	TNZ-30/121	width	300 mm	BU	<i>Royal</i> CAPITAL <i>Sentima</i> TRAFFIC	[11] [34] [35] [36] [3]P [4] [7] [9] [12]P [4-] [5-] [6-] [7-]
			depth	300 mm	DW		
			height	1208 mm	KAS		
					OLS WIEL WISE WISP		
TNZU2F-30/121-LUV		packages	carcass dimensions		carcass colours	available in	comments
	carcass	TNZU2F-30/121	width	300 mm	KAS	<i>Royal</i> CAPITAL	[11] [34] [35]
	door	1198/466-UV (-LUV)	depth	300 mm	WISE		
			height	1208 mm	WISP		
TNZU2F-30/121-LUH		packages	carcass dimensions		carcass colours	available in	comments
	carcass	TNZU2F-30/121	width	300 mm	KAS	<i>Royal</i>	[11]
	door	1195/466-UH	depth	300 mm	WISE		
			height	1208 mm	WISP		
TNZU2F-30/121-PUV		packages	carcass dimensions		carcass colours	available in	comments
	carcass	TNZU2F-30/121	width	300 mm	KAS	<i>Royal</i> CAPITAL	[11] [34] [35]
	door	1198/466-UV (-PUV)	depth	300 mm	WISE		
			height	1208 mm	WISP		
TNZU2F-30/121-PUH		packages	carcass dimensions		carcass colours	available in	comments
	carcass	TNZU2F-30/121	width	300 mm	KAS	<i>Royal</i>	[11]
	door	1195/466-UH	depth	300 mm	WISE		
			height	1208 mm	WISP		
TNZR-30/121		packages	carcass dimensions		carcass colours	available in	comments
	carcass	TNZR-30/121	width	300 mm	DW	<i>Royal</i>	[22] [25] [14] [15] [16]
			depth	300 mm	KA		
			height	1208 mm	KAS		
					OLS WISP		
TNZRF-30/121-LRV		packages	carcass dimensions		carcass colours	available in	comments
	carcass	TNZRF-30/121	width	300 mm	DW	<i>Royal</i>	[22] [25] [14] [15] [16]
	door	1198/300-LRV	depth	300 mm	KA		
			height	1208 mm	KAS		
					OLS WISP		
TNZRF-30/121-PRV		packages	carcass dimensions		carcass colours	available in	comments
	carcass	TNZRF-30/121	width	300 mm	DW	<i>Royal</i>	[22] [25] [14] [15] [16]
	door	1198/300-PRV	depth	300 mm	KA		
			height	1208 mm	KAS		
					OLS WISP		